



RT100

RT100 PRODUCT GUIDE

Complies with ANSI B30.5

Rough Terrain Crane

100 metric ton (110 ton lift capacity)

43 m (141' main boom)

11 - 19 m (35' - 60' jib)



CONTENTS

2 FEATURES

3 KEY / SYMBOLS

4-6 TECHNICAL DESCRIPTION

7 CRANE AND COMPONENT WEIGHTS

8 CRANE DIMENSIONS

9 WORKING RANGE DIAGRAM

10-15 LOAD CHARTS



HEADQUARTERS

Global Machinery & Equipment, LLC.
14800 Jersey Shore Drive, Houston, TX 77047 USA
Phone: +1 (713) 586-8808 | Fax: +1 (713) 586-8805
Info@globalcranesales.com | www.globalcranesales.com

FEATURES



Formed boom made with high-yield steel which reduces the operating weight of the boom and maximizes performance.



We chose the AxleTech brand axle because AxleTech offers the most reliable product on the market and has years of experience in manufacturing mobile crane axles.



Full vision operator cab is designed for maximum comfort and ease of operation.



The Dana 16.4HR 36626 transmission offers the latest technology for the diverse needs of off-road cranes.

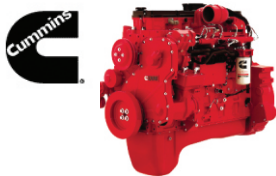

The Cummins QSC 8.3 diesel engine is TIER-III compliant and is proven to have superior performance and durability.

Greer RCI 777 LMI (load moment indicator) delivers the industry's most reliable electronic monitoring system available.

























STANDARD EQUIPMENT

- Formed boom
- Offsettable jib 0° - 20° - 40°
- Auxiliary winch
- Cameras
- Auxiliary lifting sheave
- 100 ton hook block
- 7.7 ton hook ball
- Rotation resistant wire rope
- Deluxe tilt seat
- Air conditioner / Heater
- Work light package: boom, cab and super structure
- Revolving amber light
- AM/FM radio
- Battery disconnect switch
- Front and rear lift lugs

ANSI & CE certified

KEY / SYMBOLS

	Engine	p4		Load Moment Indicator (LMI)	p5
	Transmission	p4		Max. boom length with jib ext.	p5
	Axles	p4		Main boom	p6
	Steering	p4		Main and auxiliary winches	p6
	Gradeability	p4		Cameras	p6
	Brakes	p4		Hook block	p6
	Tires and wheels	p4		Hook ball	p6
	Outrigger system (100%, 50%, 0% extended)	p4		Crane with counterweight	p7
	Hydraulic system	p5		Side stowed jib	p7
	Operator cab	p5		Distance from the hook to the head	p8
	Counterweight	p5		Tip height	p9
	Swing	p5		Working radius	p9

TECHNICAL DESCRIPTION



ENGINE

Cummins QSC 8.3 Inline 6 cylinder intercooled turbo diesel.
Horsepower Hp (kW) 305 (224) @ 2200 rpm.
Peak torque ft. lb. (Nm) 1000 (1356) @ 1500 rpm.
80 gallon (303 L) fuel tank capacity.

USA Federal EPA / California ARB / European EU / Tier III emission rating.



TRANSMISSION

Dana powershift (16.4HR 36626) transmission - 6 speeds forward and 3 speeds reverse.
Front axle disconnect offering both 4x4 and 4x2 operation.
Max. speed 14.9 mph (24 km/hr).



AXLES

Axletech front and rear steering axles with planetary reduction.
Front - Rigid mount.
Rear - Full floating rear axle. Automatic rear axle oscillating lock occurs when superstructure is swung 10° from centerline in either direction.



STEERING

Power steering with four independent modes.
Front-Wheel
Rear-Wheel
All-Wheel
Crab

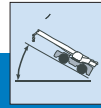

GRADEABILITY

74% max. gradeability in 1st gear 4x4.
3.7% max. gradeability in 6th gear 4x2.



BRAKES

18.5 inches (470 mm) diameter disc brakes on all wheels hydraulically operated.



TIRES AND WHEELS

29.5R29 radial, earthmoving style tires. Steel disc wheels.

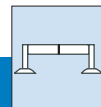

OUTRIGGER SYSTEM

Four independent horizontal beams and vertical jacks with integral holding valves, each independently controlled from operator cab.
100% - Fully extended outriggers
footprint 25.9 sq. ft. (7.9 sq. m).
50% - Mid position outriggers
footprint 18.2 sq. ft. (5.54 sq. m).
0% - Fully retracted outriggers
footprint 10.4 sq. ft. (3.18 sq. m).
Light-weight aluminum, quick-release outrigger pontoons.
Floating ground bearing area (0.27 sq. m) (418.5 sq. in).
Outrigger span Length 26.3 ft. (8 m).
Width 25.9 ft. (7.9 m).

TECHNICAL DESCRIPTION



HYDRAULIC SYSTEM

PERMCO hydraulic pumps.
 Gear pump for main and auxiliary winches, boom hoist and telescope cylinders.
 Gear pump for steering.
 Gear pump for outriggers and slewing.
 396.3 gallon (1500 L) hydraulic reservoir with external sight and temperature gauge.

Easily accessible (10 micron) cartridge style full flow filters with bypass protection.
 Max. operating pressure: 30MPa (4351 psi, 300 bar).



OPERATOR CAB

Full vision operator cab designed for max. comfort. All steel fabrication with acoustical lining and tinted safety glass throughout. The cab has a sliding door on the left and a sliding window on the right with a swing-up skylight with retractable shade and wiper motor. Fully adjustable deluxe seat with tilt. Foot controls for boom telescope, service brake and engine throttle. Tilt steering.

Temperature control is provided by a hydraulically driven air conditioning unit. Easy view dashboard with gauges for all engine sensors and rocker switch outrigger controls. Standard amenities also include bubble level, dome light, left side rearview mirror, seat belt, travel swing lock and signal horn.



COUNTERWEIGHT

Single 22,000 lbs. (10,800 kg) hyd removable counterweight.
 Length 10.5 ft. (3.2 m).
 Width 4.3 ft. (1.3 m).
 Height 2.9 ft. (0.9 m).



SWING

Bi-directional hydraulic swing drive with multi-disc wet brake and planetary reduction gearbox. Spring applied hydraulically released swing brake and 360° pneumatic positive swing lock.
 Max. swing speed: 1.5 rpm.



LOAD MOMENT INDICATOR (LMI)

GREER RCI 777 LMI control system. Microguard graphic display load moment and anti-two block system with audio-visual warning and function limiter.

System displays the following information: crane configuration, boom length, boom angle, load radius, allowed capacity, actual load, and load percentage of allowed capacity.

System includes settable work parameters: min./max. boom length, min./max. boom angle, defined swing area.

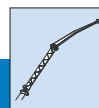

MAX. BOOM LENGTH WITH JIB EXTENSION

35.4-60.7 ft. (10.8-18.5 m) jib consisting of 35.4 ft. (10.8 m) lattice side stow jib and 25 ft. (8 m) manual pull out section. Main jib is offsettable at 0°, 20° and 40°.
 Max. tip height with 35.4 ft. (10.8 m) jib erected is 184 ft. (56.1 m).
 Max. tip height with 35.4 ft. (10.8 m) jib + 25 ft. (7.7 m) fixed pullout extension is 207 ft. (63 m).

TECHNICAL DESCRIPTION



MAIN BOOM

Four section, full power, synchronized boom. Boom is constructed of high-yield steel. 5 sheave quick reeve boom tip with removable rope guards. Rope termination lugs on both sides of boom head. Auxiliary lifting sheave and manual angle indicator are included.

Fully extended boom length: 141 ft. (43 m).
 Fully retracted boom length: 37.7 ft. (11.5 m).
 Max. tip height, main boom: 149.6 ft. (45.6 m).

Boom angle range (min./max.) -3° / + 78°.
 Boom raising / lowering time 82 sec. / 69 sec.
 Boom extension / retraction time 170 sec. / 158 sec.

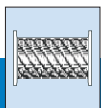

MAIN AND AUXILIARY WINCHES

Standard two speed main and auxiliary hoists, each with planetary reduction and spring applied multi-disk wet brake.

Each hoist features:

Grooved drum lagging.

Hoist drum cable followers.

Max. permissible line pull: 21,605 lbs. (9800 kg).

Winch speed: 0 - 413 fpm. (126 m/min).

Power up / power down.

Electronic drum rotation indicators.

Rope construction: 0.79 in. (20 mm) rotation resistant compacted strand.



CAMERAS

The crane comes equipped with two cameras, a winch camera for viewing hoist operation and a rear camera for viewing the rear of the crane. The monitor is located in the cab, and one can easily toggle between both camera views.

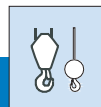

HOOK BLOCK AND HOOK BALL

100 ton, 5 sheave (steel), standard reeve hook block with odd part pin-off and safety latch.





Hook block weight 1951 lbs. (885 kg).

7.7 ton top swivel hook ball with safety latch.

Hook ball weight 360.5 lbs. (164 kg).

CRANE AND COMPONENT WEIGHTS

CRANE OPERATING WEIGHTS						
 Crane with ctwt.	Gross Vehicle Weight		Front Axle Load		Rear Axle Load	
	lb	kg	lb	kg	lb	kg
	143,300	65,000	73,193	33,200	70,107	31,800

DEDUCTIONS FOR LOAD HANDLING					
 Jib stowed aside boom  Auxiliary head	lb	kg	 5 sheave 100 ton hook block  7.7 ton hook ball	lb	kg
		2,738		1,242	
	158	72		360.5	164

TURNING RADIUS

Front Wheel (4x2) Steering	Imperial	Metric
Wall to wall over boom attached	46 ft. 2 in	14.1 m
All Wheel (4x4) Steering	Imperial	Metric
Curb to curb	26 ft. 9 in	8.2 m
Tail Swing	Imperial	Metric
With counterweight	14 ft. 2 in	4.6 m

CRANE DIMENSIONS

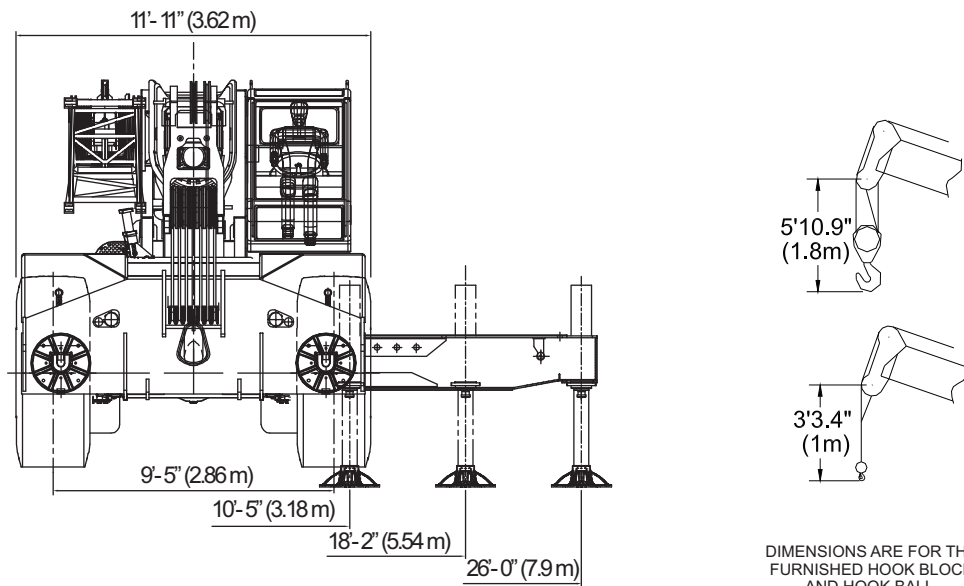
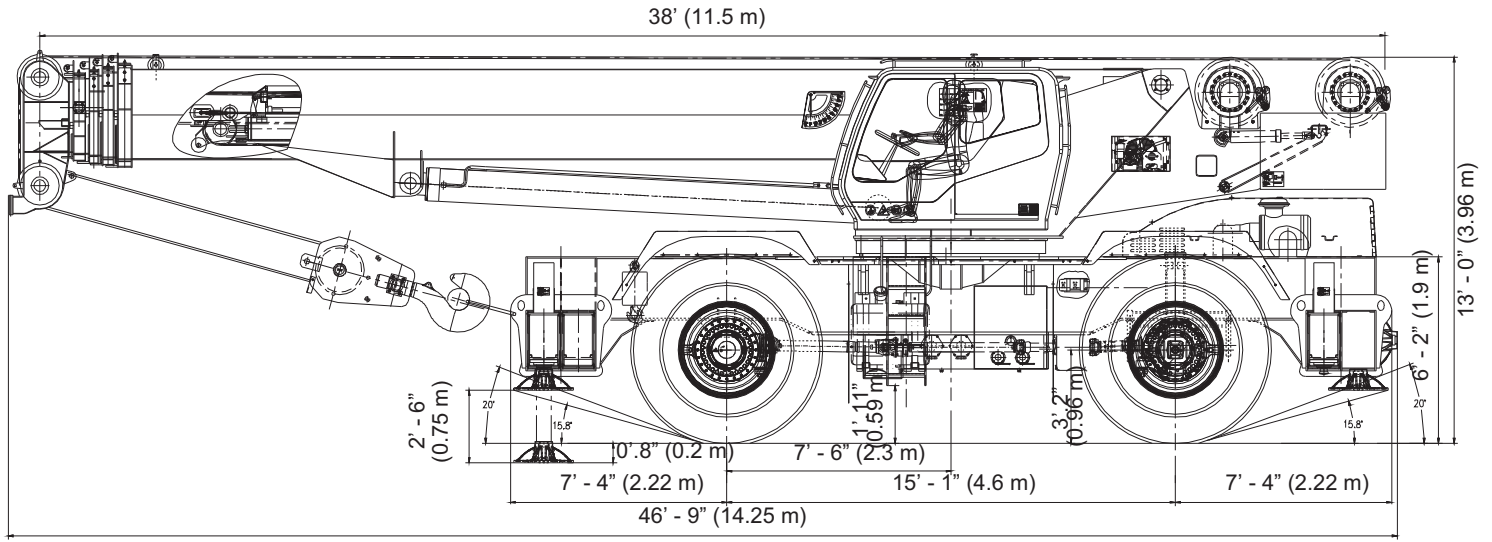



WORKING RANGE DIAGRAM

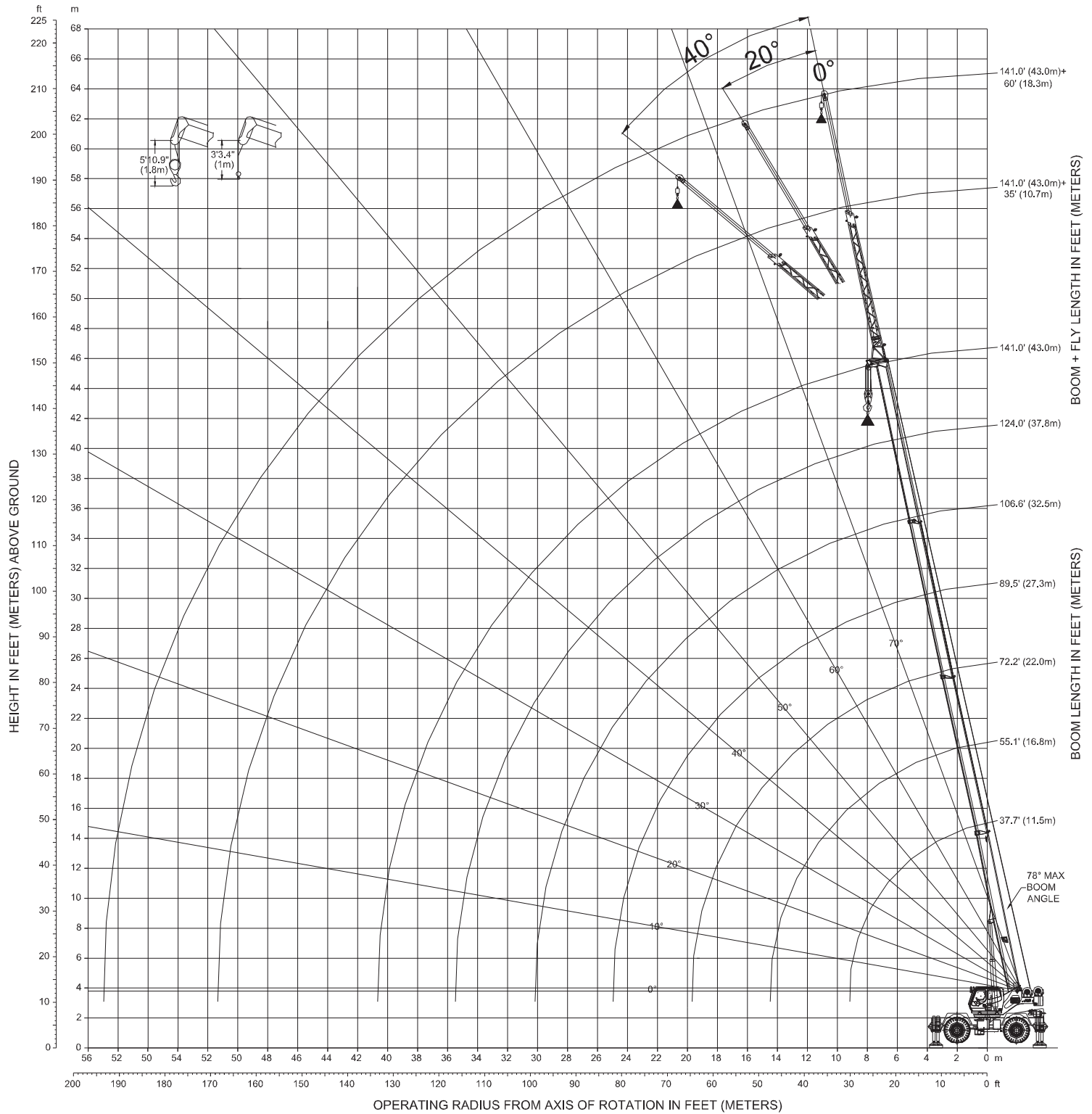

 FULLY EXTENDED OUTRIGGERS - MAIN BOOM CAPACITY 10,000 kg. ctwt. ANSI B30.5 85% 360°										
BOOM LENGTH IN METERS - CAPACITY LISTED IN KILOGRAMS										
RADIUS	11.5	15.4	19.3	23.2	27.2	31.1	35.0	39.0	43.0	RADIUS
M										M
3.0	100000	43350								3.0
3.5	96750	43350								3.5
4.0	84550	43350	43690							4.0
4.5	74250	43350	41990							4.5
5.0	66050	43350	40040	30490						5.0
5.5	59350	43350	38290	29190						5.5
6.0	53750	43350	36690	28040	23140					6.0
6.5	48970	43350	35190	26990	22290					6.5
7.0	44910	43350	33840	25990	21490	18440				7.0
7.5	41380	42340	32540	25040	20790	17840				7.5
8.0	38320	39290	31390	24190	20090	17290	14540			8.0
9.0	33190	34180	29290	22640	18840	16290	13740	13140		9.0
10.0		29630	27490	21290	17790	15390	13040	12540	9740	10.0
11.0		24690	24970	20090	16790	14590	12440	11990	9290	11.0
12.0		20960	21330	18990	15940	13840	11840	11490	8890	12.0
14.0			16210	16100	14440	12590	10840	10590	8140	14.0
16.0			12820	12840	12680	11490	9990	9790	7540	16.0
18.0				10500	10450	10140	9190	8950	6990	18.0
20.0				8780	8760	8560	8250	7540	6490	20.0
22.0					7450	7300	7080	6410	5970	22.0
24.0						6290	6120	5480	5040	24.0
26.0						5470	5330	4700	4260	26.0
28.0						4830	4670	4050	3610	28.0
30.0							4120	3500	3050	30.0
32.0							3700	3030	2570	32.0
34.0								2640	2150	34.0
36.0								2330	1800	36.0
38.0									1500	38.0
40.0									1270	40.0

LIFTING CAPACITY NOTES:

Rated lifting capacities shown do not exceed 85% of the tipping loads. The weight of the hook block, hook ball and any additional auxiliary lifting devices are not calculated into the rated lifting capacity and must be deducted prior to operation.

 MID POSITION OUTRIGGERS - MAIN BOOM CAPACITY 10,000 kg. ctwt. ANSI B30.5 85% 360°								
BOOM LENGTH IN METERS - CAPACITY LISTED IN KILOGRAMS								
RADIUS	12	16	20	23	27	31	39	RADIUS
M								M
3	99790	76335	57030					3
4	86239	71385	53726					4
5	65912	63961	48770	40560	34772			5
6	46071	45935	41572	35471	30781	26340		6
8	29202	29778	27987	27129	25787	23591	16860	8
9	20416	21233	20443	20076	19414	18153	15563	9
11		15962	15653	15526	15213	14442	12873	11
12		12410	12347	12347	12224	11753	10700	12
14			9938	10006	9997	9711	8995	14
15			8128	8219	8278	8115	7625	15
17			6763	6817	6913	6827	6505	17
18				5706	5806	5774	5575	18
20				4822	4894	4899	4763	20
21					4141	4159	4114	21
23					3515	3533	3533	23
24					3025	2998	3025	24
26						2545	2576	26
27						2168	2186	27
29						4631	1842	29
30							1533	30
32							1266	32
34							1039	34
35							871	35

LIFTING CAPACITY NOTES:

Rated lifting capacities shown do not exceed 85% of the tipping loads. The weight of the hook block, hook ball and any additional auxiliary lifting devices are not calculated into the rated lifting capacity and must be deducted prior to operation.

 FULLY RETRACTED OUTRIGGERS - MAIN BOOM CAPACITY 10,000 kg. cwt. ANSI B30.5 85% 360°								
BOOM LENGTH IN METERS - CAPACITY LISTED IN KILOGRAMS								
RADIUS	12	16	20	23	27	31	38	RADIUS
M								M
3	83325	76335	57030					3
4	55765	54109	46117					4
5	36029	35816	32024	30232	27783			5
6	21106	21632	20217	19586	18556	16860		6
8	13853	14556	14002	13798	13363	12451	10773	8
9	9471	10324	10170	10160	10006	9503	8473	9
11		7516	7570	7666	7670	7394	6759	11
12		5534	5702	5851	5942	5815	5434	12
14			4300	4477	4622	4586	4377	14
15			3225	3411	3583	3602	3515	15
17			2409	2558	2740	2803	2799	17
18				1878	2055	2141	2200	18
20				1338	1483	1583	1687	20
21					1012	1111	1247	21
23					621	712	862	23

10,000 kg. cwt.		ON TIRES BOOM CENTERED ANSI B30.5		75% OVER FRONT	
BOOM LENGTH IN METERS - CAPACITY LISTED IN KILOGRAMS					
RADIUS	11	17	22	RADIUS	
M					M
3	50793	41867			3
4	46003	41867	40733		4
5	40116	40714	40733		5
6	32582	33330	39866		6
8	27070	27905	32881		8
9	22843	23732	27674		9
11		20421	23673		11
12		17758	20530		12
14		15567	17958		14
15		9521	15812		15
17			14066		17
18			12546		18
20			11077		20

 10,000 kg. ctwt.		360° ON TIRES ANSI B30.5		75%	360°
BOOM LENGTH IN METERS - CAPACITY LISTED IN KILOGRAMS					
RADIUS	11	17	22		RADIUS
M					M
3	38750	34001			3
4	32287	28898	27914		4
5	25270	23179	22648		5
6	15545	16279	15994		6
8	9730	10537	10655		8
9	6182	7053	7357		9
11		4731	5121		11
12		3080	3511		12
14		1864	2295		14
15		1402	1356		15
17			612		17

LOCATIONS



Global Equipment is the Exclusive Worldwide Distributor for Zoomlion Rough Terrain Cranes and all prices and availability will be negotiated with Global Equipment.



HEADQUARTERS

Global Machinery & Equipment, LLC
14800 Jersey Shore Drive,
Houston, TX 77047 USA
Toll Free: (866) 278-9780
Phone: +1 (713) 586-8808 | Fax: +1 (713) 586-8805
info@globalcranesales.com | www.globalcranesales.com

Uri Toudjarov

E-mail: uri@globalcranesales.com
Cell: +1 (602) 320-0762

Ed Gibson - North America

E-mail: egibson@globalcranesales.com
Direct: +1 (310) 749-0634

Due to constant improvement and engineering, we reserve the right to change the design, specifications, and equipment pricing without notification. Illustrations provided may or may not include all standard and optional equipment and accessories.