

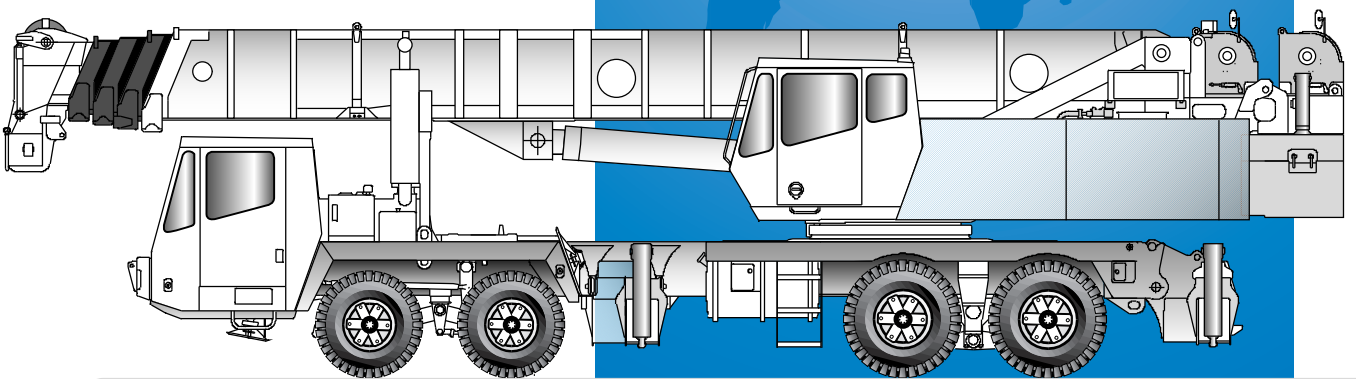

GROVE[®]
CRANE

TM9100



Truck Mounted Hydraulic Crane

Dimensions

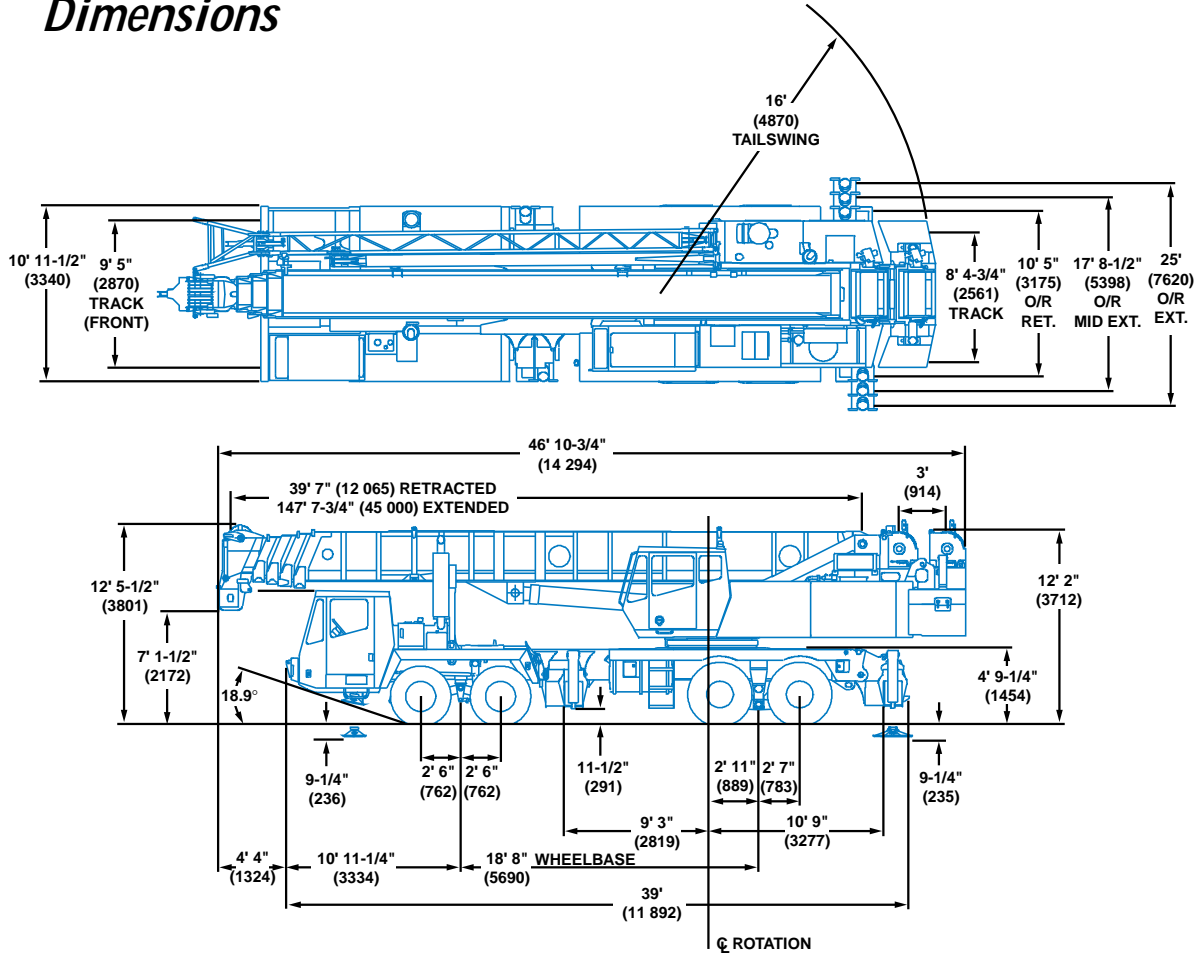

Note: () Reference dimensions in mm

Curb Turning Radius 41' (12 500 mm)

ALLOWABLE WEIGHTS	FRONT	REAR	GROSS
Axle/Tire Capacities	49,200 lbs. (22 317 kg)	76,880 lbs. (34 873 kg)	126,080 lbs. (57 190 kg)
FIVE SECTION BOOM	FRONT	REAR	GROSS
Base machine with 148 ft. (45 m) boom, aluminum wheels	40,881 lbs. (18 544 kg)	64,377 lbs. (29 201 kg)	105,258 lbs. (47 745 kg)
31 - 56 ft. (9.5 - 17 m) folding swingaway	2,174 lbs. (986 kg)	139 lbs. (63 kg)	2,313 lbs. (1049 kg)
Auxiliary hoist w/rope & mtg.	- 2,225 lbs. (- 1009 kg)	5,745 lbs. (2606 kg)	3,520 lbs. (1597 kg)
Auxiliary boom nose	292 lbs. (132 kg)	- 136 lbs. (- 62 kg)	156 lbs. (71 kg)
100 ton block	3,647 lbs. (1654 kg)	- 1,094 lbs. (- 496 kg)	2,553 lbs. (1158 kg)
65 ton block	2,249 lbs. (1020 kg)	- 675 lbs. (- 306 kg)	1,574 lbs. (714 kg)
45 ton block	1,564 lbs. (709 kg)	- 469 lbs. (- 213 kg)	1,095 lbs. (497 kg)
10 ton ball	800 lbs. (363 kg)	- 240 lbs. (- 109 kg)	560 lbs. (254 kg)
16,300 lbs. (7400 kg) counterweight on s/s	- 9,969 lbs. (- 4522 kg)	26,269 lbs. (11 916 kg)	16,300 lbs. (7394 kg)
16,300 lbs. (7400 kg) counterweight on carrier	N/A	N/A	16,300 lbs. (7394 kg)
7,700 lbs. (3500 kg) counterweight on s/s	- 4,709 lbs. (- 2136 kg)	12,409 lbs. (5629 kg)	7,700 lbs. (3493 kg)
7,700 lbs. (3500 kg) counterweight on carrier	N/A	N/A	7,700 lbs. (3493 kg)
Remove front outrigger box	- 4,098 lbs. (- 1859 kg)	- 2,190 lbs. (- 993 kg)	- 6,288 lbs. (- 2852 kg)
Remove rear outrigger box	2,721 lbs. (1234 kg)	- 9,206 lbs. (- 4176 kg)	- 6,485 lbs. (- 2942 kg)

Note: Weights may vary 3% due to manufacturing tolerances

Working Range



40 - 148 ft.
(12.1 - 45.0 m)



31 - 56 ft.
(9.5 - 17.0 m)

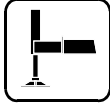

360°

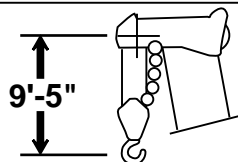
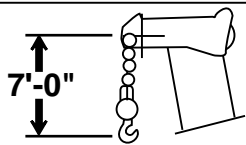
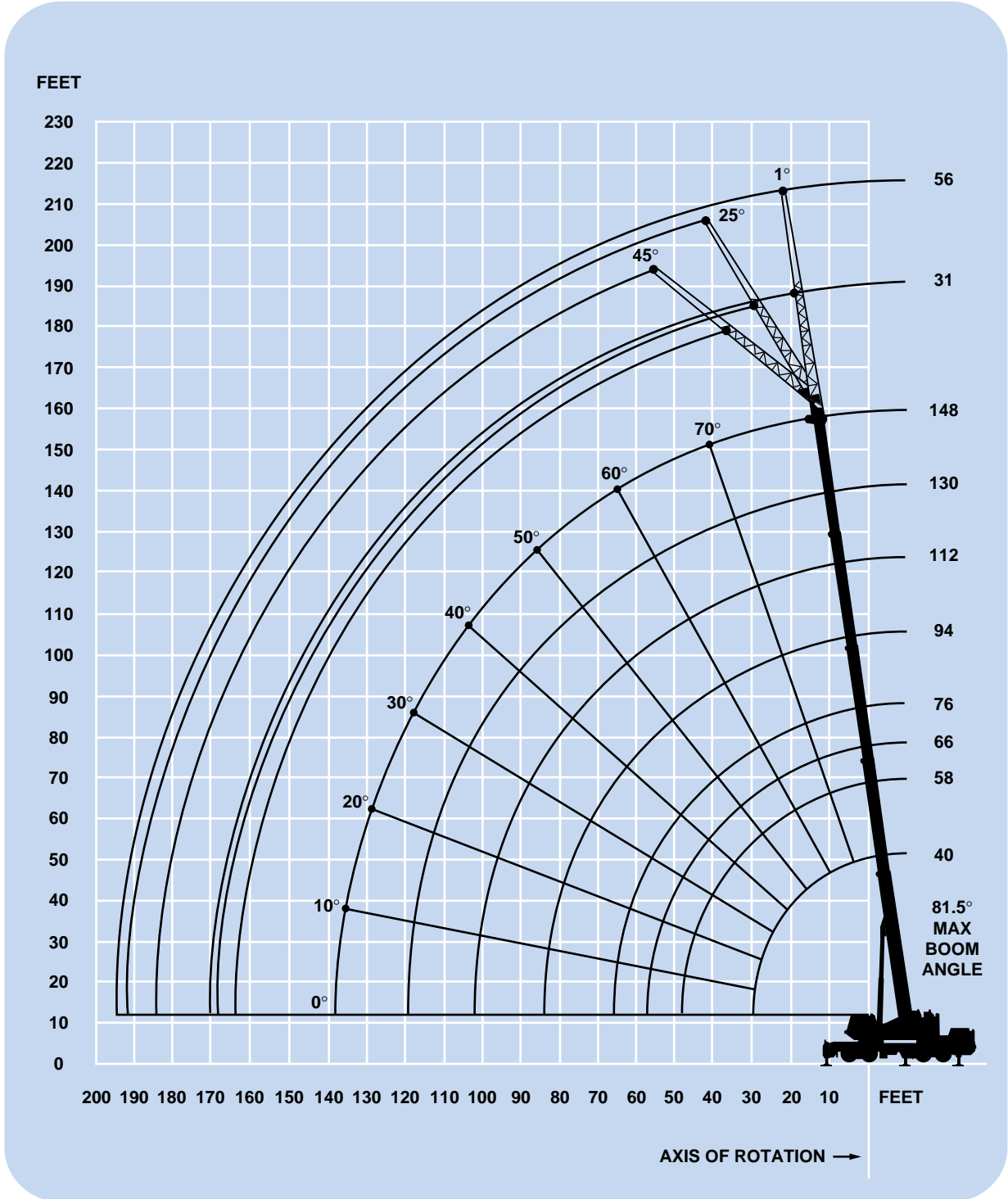

DIMENSIONS ARE FOR LARGEST GROVE FURNISHED HOOK BLOCK AND HEADACHE BALL, WITH ANTI-TWO BLOCK ACTIVATED.

Superstructure specifications

Boom

40 ft. - 148 ft. (12.1 m - 45.0 m) five-section full power boom with swingaround auxiliary boom nose. Equipped with remote greasing lines for upper rear wear pad area. Maximum Tip Height: 156 ft. (47.6 m).

Bifold Boom Extension

31 ft. to 56 ft. (9.5 m to 17 m) bi-fold lattice swingaway extension offsettable at 1.5°, 25° or 45°. Stows alongside base boom section. Maximum Tip Height: 211 ft. (64.3 m).

Boom Elevation

One double acting hydraulic cylinder with integral holding valve provides elevation from - 3° to 81.5°.

Boom Nose

Seven nylatron, permanently lubricated sheaves mounted on heavy-duty tapered roller bearings with removable pin-type rope guards. Quick reeving type boom nose. Removable auxiliary boom nose with removable pin-type rope guard.

Load Moment & Anti-Two Block System

Standard graphic load moment and anti-two block system with audio-visual warning and control lever lockout. These systems provide electronic display of boom angle, length, radius, tip height, relative load moment, maximum permissible load, actual load indication and warning of impending two-block condition. LMI light bar located in the top front of the cab.

Cab

High visibility, all steel cab with acoustical lining and tinted safety glass throughout. Deluxe seat with armrest mounted hydraulic controls. Dash panel with gauges for all engine functions. Other standard features include: sliding side window, electric windshield wash/wipe, rear view hoist mirrors, hot water heater, circulating air fan, hydraulic oil temperature light, sliding skylight with electric skylight wiper and sunscreen, fire extinguisher and seat belt.

Swing

Planetary swing with foot applied wet disc brake. Spring applied, hydraulically released parking brake, two position plunger type and 360° positive swing lock operated from cab. Maximum speed: 1.4 RPM.

Counterweight

Two piece: 7,700 lbs. (3500 kg) and 16,300 lbs. (7400 kg). Total 24,000 lbs. (10 900 kg), installed/removed hydraulically.

Engine

Cummins 6CTA8.3 diesel, 6 cylinders, turbo-charged and after-cooled. 250 hp (186 kW) @ 2200 RPM. Maximum torque: 716 ft. lbs. (971 N-m) @ 1500 RPM.

Fuel Tank Capacity

70 gallons (265 L)

Hydraulic System

Three main pumps: two high-pressure piston pumps with horsepower limiting for crane functions. One gear pump for swing and outriggers with a combined capacity of 144 GPM (545 L/min).

Pressure compensated valve banks.

Return line type filter with full flow by-pass protection and service indicator. Replaceable cartridge with filtration rating of ISO 4406 Class 17/14.

274 gallon (1039 L) reservoir.

Two remote mounted oil coolers with thermostatically controlled hydraulic motor driven fan.

System pressure test panel with ORFS type fittings.

HOIST SPECIFICATIONS Main and Auxiliary Hoist

Main and Auxiliary Hoist Model HO35A-32G.

Variable displacement piston motor with pressure override. Planetary reduction with automatic spring-applied multi-disc brake. Grooved drum with third wrap indicator. Spring tensioned cable follower. Electronic hoist drum rotation indicator. Quick Removable Auxiliary Hoist Package.

Maximum Permissible Line Pull: 12,920 lbs.
(57.6 kN)

Rope Diameter: 3/4 in.
(19 mm)

Rope Length: 900 ft.
(274 m)

Maximum Rope Stowage: 1,150 ft.
(350 m)

		High Speed	Low Speed
Maximum single line speed (no load):	Layer 1	435 fpm (132 m/min)	250 fpm (76 m/min)
	Layer 2	473 fpm (144 m/min)	272 fpm (82 m/min)
	Layer 3	512 fpm (156 m/min)	294 fpm (90 m/min)
	Layer 4	550 fpm (168 m/min)	316 fpm (96 m/min)
	Layer 5	588 fpm (179 m/min)	338 fpm (100 m/min)
Maximum single line pull:	Layer 1	10,482 lbs. (46.6 kN)	18,697 lbs. (83.2 kN)
	Layer 2	9,634 lbs. (42.8 kN)	17,184 lbs. (76.4 kN)
	Layer 3	8,913 lbs. (39.6 kN)	15,899 lbs. (70.7 kN)
	Layer 4	8,293 lbs. (36.9 kN)	14,792 lbs. (65.8 kN)
	Layer 5	7,753 lbs. (34.5 kN)	13,829 lbs. (61.5 kN)

*Denotes optional equipment

Carrier specifications

Chassis

Triple box section, four-axle carrier fabricated from high-strength, low alloy steel. Removable outrigger housings.

Outrigger System

Four hydraulic telescoping single-stage double box beam outriggers with inverted jacks and integral holding valves. Quick release type outrigger floats 30.5 in. (775 mm) diameter. Standard fifth front stabilizer with 18 in. (457 mm) diameter float. Three position setting with fully extended, intermediate (50%) extension and fully retracted capacities. Intermediate extension is manually pinned.

Maximum outrigger pad load: 128,500 lbs. (58,300 kg).

Outrigger Controls

Located in the superstructure cab (hand held) and on both sides of the carrier with lighted box, require two hand operation. Crane level indicator (sight bubble).

Engine

Cummins M11-400E Plus diesel, six cylinders, turbo-charged and after cooled. 661 cu. in. (10.8 L), 400 hp (298 kW) @ 1500 to 1800 rpm, 375 hp (280 kW) @ 2100 RPM. Maximum torque: 1,450 ft. lbs. (1966 N·m) @ 1,200 RPM with engine brake and audio-visual engine distress system.

Fuel Tank Capacity

(1) 100 gallons (378 L)

Transmission

Eaton Fuller RTX-14710C, 10 speeds forward, 2 reverse with Fuller AT 1202 two-speed auxiliary.

Drive

8 x 4 x 4

Axles

Front: (2) Eaton EFA24T5 steering tandem.
Track: 113 in. (2.87 m) track.

Rear: Rockwell RT70-180 tandem with inter-axle differential locks and No Spin differential in 4th axle. Track: 100.75 in. (2.56 m).

Suspension

Front: Spring mounted tandem.

Rear: Solid mounted tandem with equalizing beam and steel saddles.

Tires

Front: 445/65R22.5 highway tread steel-belted tubeless radial singles mounted on aluminum wheels.

Rear: 14.00R20 highway tread steel-belted tube type radial duals mounted on steel spoke wheels.

Steering

Front axle mechanical steering with hydraulic power assist. Auxiliary ground driven steer pump.

Brakes

S-cam full air split system operating on all wheels. Spring-applied, air released parking brake acting on rear axles. Air dryer.

Cab

One man design, all steel fabricated with acoustical lining and tinted safety glass throughout. Deluxe fabric covered fully adjustable air ride seat. Complete driving controls and engine instrumentation including tachometer, speedometer, voltmeter, water temp., oil pressure, fuel level, air pressure gauge with A/V warning and engine high temp/low oil pressure/low coolant level A/V warning. Other standard items include : cruise control, hot water heater/defroster, electric windshield wash/wipe, fire extinguisher, seat belt and door and window locks, power window L/H side, and sliding side window.

Electrical System

Two 12 V-low maintenance batteries.

24 V system and 12 V headlights.

Lights

Full lighting package including turn indicators, day time running lights, tail, brake, hazard warning lights, and beacon lights.

Maximum Speed

55 mph (88 km/h)

Gross Vehicle Weight

BASIC STANDARD MACHINE

137,159 lbs. (62 215 kg).

Miscellaneous Standard Equipment

Aluminum fenders and carrier decking; lifting, towing and tie down lugs; permalube drive lines; component handling slings with hooks, lockable rigging box, amber flashing light. Aluminum fuel and hydraulic tanks. Air powered greasing system for swing bearing, pivot pin, and lift cylinder shafts. Trailing boom kit (minus dolly). Superstructure light package includes boom lights, hoist light and cab work lights.



40 - 148 ft.
(12.1 - 45.0 m)



24,000 lbs.
(10 886 kg)



100%



360°



Pounds

(Feet)	39.6	66.6	93.6	111.6	147.6
10	200,000 (66)	68,800 (76.5)	47,000 (81.5)		
12	154,500 (62.5)	68,800 (74.5)	47,000 (80.5)	*37,600 (81.5)	
15	133,500 (57)	68,800 (72)	47,000 (78.5)	37,600 (81)	
20	106,500 (47)	68,300 (67.5)	46,500 (75.5)	35,800 (78.5)	*24,300 (81.5)
25	82,100 (35)	59,900 (62.5)	43,400 (72)	33,700 (76)	24,300 (80.5)
30	51,900 (12)	52,300 (57)	39,850 (68.5)	31,300 (73.5)	24,300 (78.5)
35		46,700 (51.5)	35,250 (65.5)	29,300 (70.5)	24,000 (76.5)
40		41,800 (45.5)	31,300 (62)	27,300 (67.5)	23,200 (74.5)
45		37,800 (39)	28,000 (58)	24,500 (65)	22,100 (72)
50		31,750 (30.5)	25,300 (54)	22,200 (62)	20,900 (70)
60			20,900 (46)	18,300 (55.5)	17,100 (66)
70			17,650 (35.5)	15,400 (48.5)	14,400 (61.5)
80			13,950 (21)	13,000 (41)	11,850 (56.5)
90				11,000 (31)	9,800 (51.5)
100				8,560 (15.5)	8,000 (46)
110					6,080 (40)
120					4,350 (32.5)
130					2,910 (23)
Min. boom angle (deg.) for indicated length (no load)					22

Max. boom length (ft.) at 0 degree boom angle (no load)

111.6

Note: () Boom angles are in degrees.

*This capacity is based on maximum boom angle.

Boom Angle	39.6	66.6	93.6	111.6
0°	31,900 (30.2)	13,000 (57.2)	7,460 (84.2)	5,250 (102.2)

Note: () Reference radii in feet.

A6-829-015380

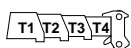

%

MODE A

T1	0	0	0	0	100
T2	0	100	100	100	100
T3	0	0	50	83	100
T4	0	0	50	83	100

THIS CHART IS ONLY A GUIDE AND SHOULD NOT BE USED TO OPERATE THE CRANE. The individual crane's load chart, operating instructions and other instructional plates must be read and understood prior to operating the crane.



40 - 148 ft.
(12.1 - 45.0 m)



7,700 lbs.
(3493 kg)



100%



360°



Pounds

(Feet)	39.6	66.6	93.6	111.6	147.6
10	196,000 (66)	68,800 (76.5)	47,000 (81.5)		
12	154,500 (62.5)	68,800 (74.5)	47,000 (80.5)	*37,600 (81.5)	
15	133,500 (57)	68,800 (72)	47,000 (78.5)	37,600 (81)	
20	106,500 (47)	68,300 (67.5)	46,500 (75.5)	35,800 (78.5)	*24,300 (81.5)
25	76,800 (35)	59,900 (62.5)	43,400 (72)	33,700 (76)	24,300 (80.5)
30	51,900 (12)	52,300 (57)	39,850 (68.5)	31,300 (73.5)	24,300 (78.5)
35		45,700 (51.5)	35,250 (65.5)	29,300 (70.5)	24,000 (76.5)
40		35,150 (45.5)	31,300 (62)	27,300 (67.5)	23,200 (74.5)
45		27,800 (39)	28,000 (58)	24,500 (65)	22,100 (72)
50		22,450 (30.5)	25,300 (54)	22,200 (62)	20,900 (70)
60			17,650 (46)	18,300 (55.5)	17,100 (66)
70			12,500 (35.5)	14,000 (48.5)	12,500 (61.5)
80			8,910 (21)	10,200 (41)	8,820 (56.5)
90				7,450 (31)	6,070 (51.5)
100				5,270 (15.5)	3,950 (46)
110					2,260 (40)
Min. boom angle (deg.) for indicated length (no load)					33

Max. boom length (ft.) at 0 degree boom angle (no load)

111.6

Note: () Boom angles are in degrees.

*This capacity is based on maximum boom angle.

Boom Angle	39.6	66.6	93.6	111.6
0°	31,900 (30.2)	13,000 (57.2)	7,460 (84.2)	4,840 (102.2)

Note: () Reference radii in feet.

A6-829-015381

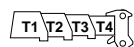

%

MODE A

	T1	T2	T3	T4
T1	0	0	0	100
T2	0	100	100	100
T3	0	0	50	100
T4	0	0	50	100



40 - 148 ft.
(12.1 - 45.0 m)



0 lbs.
(0 kg)



100%



360°



Pounds

(Feet)	39.6	66.6	93.6	111.6	147.6
10	194,000 (66)	68,800 (76.5)	47,000 (81.5)		
12	154,500 (62.5)	68,800 (74.5)	47,000 (80.5)	*37,600 (81.5)	
15	133,500 (57)	68,800 (72)	47,000 (78.5)	37,600 (81)	
20	98,900 (47)	68,300 (67.5)	46,500 (75.5)	35,800 (78.5)	*24,300 (81.5)
25	69,250 (35)	59,900 (62.5)	43,400 (72)	33,700 (76)	24,300 (80.5)
30	51,300 (12)	52,300 (57)	39,850 (68.5)	31,300 (73.5)	24,300 (78.5)
35		37,900 (51.5)	35,250 (65.5)	29,300 (70.5)	24,000 (76.5)
40		28,750 (45.5)	31,300 (62)	27,300 (67.5)	23,200 (74.5)
45		22,400 (39)	25,850 (58)	24,500 (65)	22,100 (72)
50		17,750 (30.5)	20,800 (54)	22,200 (62)	20,900 (70)
60			13,950 (46)	15,650 (55.5)	14,050 (66)
70			9,480 (35.5)	10,950 (48.5)	9,470 (61.5)
80			6,310 (21)	7,640 (41)	6,210 (56.5)
90				5,180 (31)	3,800 (51.5)
100				3,260 (15.5)	1,940 (46)
Min. boom angle (deg.) for indicated length (no load)					43
Max. boom length (ft.) at 0 degree boom angle (no load)					111.6

Note: () Boom angles are in degrees.

*This capacity is based on maximum boom angle.

Boom Angle	39.6	66.6	93.6	111.6
0°	31,900 (30.2)	12,800 (57.2)	5,210 (84.2)	2,880 (102.2)

Note: () Reference radii in feet.

A6-829-015382

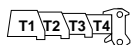

%

MODE A

	T1	T2	T3	T4
T1	0	0	0	100
T2	0	100	100	100
T3	0	0	50	100
T4	0	0	50	100



40 - 148 ft.
(12.1 - 45.0 m)



0 lbs.
(0 kg)



100%



360°

No Aux. Hoist Structure



Pounds

(Feet)	39.6	66.6	93.6	111.6	147.6
10	193,000 (66)	68,800 (76.5)	47,000 (81.5)		
12	154,500 (62.5)	68,800 (74.5)	47,000 (80.5)	*37,600 (81.5)	
15	133,500 (57)	68,800 (72)	47,000 (78.5)	37,600 (81)	
20	94,150 (47)	68,300 (67.5)	46,500 (75.5)	35,800 (78.5)	*24,300 (81.5)
25	65,700 (35)	59,900 (62.5)	43,400 (72)	33,700 (76)	24,300 (80.5)
30	48,450 (12)	49,150 (57)	39,850 (68.5)	31,300 (73.5)	24,300 (78.5)
35		35,450 (51.5)	35,250 (65.5)	29,300 (70.5)	24,000 (76.5)
40		26,750 (45.5)	30,700 (62)	27,300 (67.5)	23,200 (74.5)
45		20,700 (39)	24,150 (58)	24,500 (65)	22,100 (72)
50		16,300 (30.5)	19,350 (54)	21,350 (62)	19,650 (70)
60			12,750 (46)	14,450 (55.5)	12,900 (66)
70			8,510 (35.5)	9,990 (48.5)	8,500 (61.5)
80			5,490 (21)	6,820 (41)	5,390 (56.5)
90				4,470 (31)	3,090 (51.5)
100				2,630 (15.5)	1,310 (46)
Min. boom angle (deg.) for indicated length (no load)					44
Max. boom length (ft.) at 0 degree boom angle (no load)					111.6

Note: () Boom angles are in degrees.

*This capacity is based on maximum boom angle.

Boom Angle	39.6	66.6	93.6	111.6
0°	31,900 (30.2)	11,600 (57.2)	4,440 (84.2)	2,270 (102.2)

Note: () Reference radii in feet.

A6-829-015383



%

MODE A

	T1	T2	T3	T4	
T1	0	0	0	0	100
T2	0	100	100	100	100
T3	0	0	50	83	100
T4	0	0	50	83	100



40 - 148 ft.
(12.1 - 45.0 m)



24,000 lbs.
(10 886 kg)



100%



360°



Pounds

(Feet)	39.6	57.6	66.6	75.6	93.6	111.6	129.6	147.6
10	200,000 (66)	103,500 (74)	102,500 (76.5)	99,600 (78.5)				
12	154,500 (62.5)	103,500 (72)	102,500 (74.5)	93,600 (77)	57,500 (80)	*46,700 (81.5)		
15	133,500 (57)	102,500 (69)	95,900 (72)	85,600 (74.5)	57,500 (78.5)	46,700 (81)	*37,500 (81.5)	
20	106,500 (47)	87,900 (63)	81,500 (67.5)	74,600 (70.5)	57,300 (75)	46,700 (78)	37,500 (80.5)	*24,300 (81.5)
25	82,100 (35)	76,900 (57)	69,600 (62.5)	64,450 (66.5)	52,600 (72)	44,100 (75.5)	37,500 (78.5)	24,300 (80.5)
30	51,900 (12)	67,800 (51)	60,100 (57)	56,000 (62)	45,300 (68.5)	40,000 (73)	36,200 (76)	24,300 (78.5)
35		53,600 (43.5)	52,800 (51.5)	49,450 (57.5)	39,400 (65)	36,100 (70)	33,400 (73.5)	24,000 (76.5)
40		43,000 (35)	43,750 (45.5)	43,700 (53)	34,300 (61.5)	31,500 (67)	29,600 (71)	23,200 (74.5)
45		35,000 (23)	35,800 (39)	36,350 (47.5)	30,300 (58)	27,800 (64.5)	26,200 (69)	22,100 (72)
50			29,050 (30.5)	29,600 (42)	26,900 (54)	24,650 (61.5)	23,250 (66.5)	20,900 (70)
60				20,250 (27)	20,050 (45.5)	19,700 (55)	18,600 (61.5)	17,100 (66)
70					14,050 (35.5)	15,550 (48)	15,100 (56)	14,400 (61.5)
80					9,590 (21)	11,150 (40.5)	12,300 (50)	11,850 (56.5)
90						7,820 (30.5)	9,340 (43.5)	9,800 (51.5)
100						5,210 (15)	6,720 (36)	8,000 (46)
110							4,630 (26.5)	6,080 (40)
120								4,350 (32.5)
130								2,910 (23)
Minimum boom angle (deg.) for indicated length (no load)							21	22

Maximum boom length (ft.) at 0 degree boom angle (no load)

111.6

Note: () Boom angles are in degrees.

*This capacity is based on maximum boom angle.

Boom Angle	39.6	57.6	66.6	75.6	93.6	111.6
0°	31,900 (30.2)	15,300 (48.2)	11,150 (57.2)	8,020 (66.2)	2,860 (84.2)	1,380 (102.2)

Note: () Reference radii in feet.

A6-829-015367

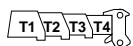

%

MODE B

T1	0	67	67	67	100	100	100	100
T2	0	0	33	67	100	100	100	100
T3	0	0	0	0	0	33	67	100
T4	0	0	0	0	0	33	67	100

THIS CHART IS ONLY A GUIDE AND SHOULD NOT BE USED TO OPERATE THE CRANE. The individual crane's load chart, operating instructions and other instructional plates must be read and understood prior to operating the crane.



40 - 148 ft.
(12.1 - 45.0 m)



7,700 lbs.
(3493 kg)



100%



360°



Pounds

(Feet)	39.6	57.6	66.6	75.6	93.6	111.6	129.6	147.6
10	196,000 (66)	103,500 (74)	102,500 (76.5)	99,600 (78.5)				
12	154,500 (62.5)	103,500 (72)	102,500 (74.5)	93,600 (77)	57,500 (80)	*46,700 (81.5)		
15	133,500 (57)	102,500 (69)	95,900 (72)	85,600 (74.5)	57,500 (78.5)	46,700 (81)	*37,500 (81.5)	
20	106,500 (47)	87,900 (63)	81,500 (67.5)	74,600 (70.5)	57,300 (75)	46,700 (78)	37,500 (80.5)	*24,300 (81.5)
25	76,800 (35)	74,650 (57)	69,600 (62.5)	64,450 (66.5)	52,600 (72)	44,100 (75.5)	37,500 (78.5)	24,300 (80.5)
30	51,900 (12)	55,650 (51)	56,450 (57)	56,000 (62)	45,300 (68.5)	40,000 (73)	36,200 (76)	24,300 (78.5)
35		42,950 (43.5)	43,450 (51.5)	43,750 (57.5)	39,400 (65)	36,100 (70)	33,400 (73.5)	24,000 (76.5)
40		32,550 (35)	33,050 (45.5)	33,500 (53)	32,700 (61.5)	31,500 (67)	29,600 (71)	23,200 (74.5)
45		25,050 (23)	25,550 (39)	26,100 (47.5)	25,600 (58)	27,400 (64.5)	26,200 (69)	22,100 (72)
50			20,000 (30.5)	20,500 (42)	20,100 (54)	22,000 (61.5)	23,250 (66.5)	20,900 (70)
60				12,850 (27)	12,500 (45.5)	14,250 (55)	16,000 (61.5)	17,100 (66)
70					7,580 (35.5)	9,230 (48)	10,850 (56)	12,500 (61.5)
80					4,090 (21)	5,670 (40.5)	7,240 (50)	8,820 (56.5)
90						3,030 (30.5)	4,550 (43.5)	6,070 (51.5)
100							2,470 (36)	3,950 (46)
110								2,260 (40)
Minimum boom angle (deg.) for indicated length (no load)						16	27	33
Maximum boom length (ft.) at 0 degree boom angle (no load)						93.6		

Note: () Boom angles are in degrees.

*This capacity is based on maximum boom angle.

Boom Angle	39.6	57.6	66.6	75.6	93.6
0°	31,900 (30.2)	15,300 (48.2)	11,150 (57.2)	8,020 (66.2)	2,860 (84.2)

Note: () Reference radii in feet.

A6-829-015368

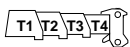

%

MODE B

	T1	T2	T3	T4
T1	0	67	67	67
T2	0	0	33	67
T3	0	0	0	0
T4	0	0	0	0



40 - 148 ft.
(12.1 - 45.0 m)



0 lbs.
(0 kg)



100%



360°



Pounds

(Feet)	39.6	57.6	66.6	75.6	93.6	111.6	129.6	147.6
10	194,000 (66)	103,500 (74)	102,500 (76.5)	99,600 (78.5)				
12	154,500 (62.5)	103,500 (72)	102,500 (74.5)	93,600 (77)	57,500 (80)	*46,700 (81.5)		
15	133,500 (57)	102,500 (69)	95,900 (72)	85,600 (74.5)	57,500 (78.5)	46,700 (81)	*37,500 (81.5)	
20	98,900 (47)	87,900 (63)	81,500 (67.5)	74,600 (70.5)	57,300 (75)	46,700 (78)	37,500 (80.5)	*24,300 (81.5)
25	69,250 (35)	67,100 (57)	67,950 (62.5)	64,450 (66.5)	52,600 (72)	44,100 (75.5)	37,500 (78.5)	24,300 (80.5)
30	51,300 (12)	49,600 (51)	50,400 (57)	50,900 (62)	45,300 (68.5)	40,000 (73)	36,200 (76)	24,300 (78.5)
35		35,600 (43.5)	36,250 (51.5)	36,900 (57.5)	35,900 (65)	36,100 (70)	33,400 (73.5)	24,000 (76.5)
40		26,150 (35)	26,750 (45.5)	27,300 (53)	26,850 (61.5)	28,950 (67)	29,600 (71)	23,200 (74.5)
45		19,650 (23)	20,150 (39)	20,650 (47.5)	20,250 (58)	22,300 (64.5)	24,300 (69)	22,100 (72)
50			15,350 (30.5)	15,800 (42)	15,450 (54)	17,350 (61.5)	19,250 (66.5)	20,900 (70)
60				9,180 (27)	8,840 (45.5)	10,550 (55)	12,300 (61.5)	14,050 (66)
70					4,530 (35.5)	6,170 (48)	7,820 (56)	9,470 (61.5)
80					1,480 (21)	3,070 (40.5)	4,640 (50)	6,210 (56.5)
90							2,280 (43.5)	3,800 (51.5)
100								1,940 (46)
Minimum boom angle (deg.) for indicated length (no load)					15	32	40	43
Maximum boom length (ft.) at 0 degree boom angle (no load)							75.6	

Note: () Boom angles are in degrees.
*This capacity is based on maximum boom angle.

Boom Angle	39.6	57.6	66.6	75.6
0°	31,900 (30.2)	15,300 (48.2)	10,200 (57.2)	6,240 (66.2)

Note: () Reference radii in feet.

A6-829-015369

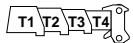

% MODE B

	T1	T2	T3	T4
T1	0	67	67	67
T2	0	0	33	67
T3	0	0	0	0
T4	0	0	0	0



40 - 148 ft.
(12.1 - 45.0 m)



0 lbs.
(0 kg)



100%



360°

No Aux. Hoist Structure



(Feet)



Pounds

(Feet)	39.6	57.6	66.6	75.6	93.6	111.6	129.6	147.6
10	193,000 (66)	103,500 (74)	102,500 (76.5)	99,600 (78.5)				
12	154,500 (62.5)	103,500 (72)	102,500 (74.5)	93,600 (77)	57,500 (80)	*46,700 (81.5)		
15	133,500 (57)	102,500 (69)	95,900 (72)	85,600 (74.5)	57,500 (78.5)	46,700 (81)	*37,500 (81.5)	
20	94,150 (47)	87,900 (63)	81,500 (67.5)	74,600 (70.5)	57,300 (75)	46,700 (78)	37,500 (80.5)	*24,300 (81.5)
25	65,700 (35)	63,550 (57)	64,400 (62.5)	64,450 (66.5)	52,600 (72)	44,100 (75.5)	37,500 (78.5)	24,300 (80.5)
30	48,450 (12)	46,750 (51)	47,550 (57)	48,150 (62)	45,300 (68.5)	40,000 (73)	36,200 (76)	24,300 (78.5)
35		33,100 (43.5)	33,750 (51.5)	34,400 (57.5)	33,750 (65)	35,800 (70)	33,400 (73.5)	24,000 (76.5)
40		24,150 (35)	24,700 (45.5)	25,300 (53)	24,850 (61.5)	27,000 (67)	29,100 (71)	23,200 (74.5)
45		17,950 (23)	18,450 (39)	18,950 (47.5)	18,550 (58)	20,600 (64.5)	22,600 (69)	22,100 (72)
50			13,850 (30.5)	14,350 (42)	13,950 (54)	15,850 (61.5)	17,750 (66.5)	19,650 (70)
60				8,010 (27)	7,670 (45.5)	9,420 (55)	11,150 (61.5)	12,900 (66)
70					3,560 (35.5)	5,210 (48)	6,860 (56)	8,500 (61.5)
80						2,250 (40.5)	3,820 (50)	5,390 (56.5)
90							1,570 (43.5)	3,090 (51.5)
100								1,310 (46)
Minimum boom angle (deg.) for indicated length (no load)					23	36	41	44
Maximum boom length (ft.) at 0 degree boom angle (no load)							75.6	

Note: () Boom angles are in degrees.
*This capacity is based on maximum boom angle.

Boom Angle	39.6	57.6	66.6	75.6
0°	31,900 (30.2)	14,800 (48.2)	9,000 (57.2)	5,210 (66.2)

Note: () Reference radii in feet.

A6-829-015370

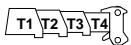

%

MODE B

	T1	T2	T3	T4
T1	0	67	67	67
T2	0	0	33	67
T3	0	0	0	0
T4	0	0	0	0



148 ft.
(45.0 m)



31 - 56 ft.
(9.4 - 17.1 m)



24,000 lbs.
(10 886 kg)



100%



360°



Pounds

(Feet)	31 FT. LENGTH			56 FT. LENGTH		
	1° OFFSET	25° OFFSET	45° OFFSET	1° OFFSET	25° OFFSET	45° OFFSET
25	*11,700 (81.5)					
30	11,700 (81)			*5,820 (81.5)		
35	11,700 (79.5)			5,820 (81)		
40	11,050 (77.5)	9,600 (80.5)		5,820 (80)		
45	10,400 (76)	9,600 (79)	7,250 (81)	5,820 (78.5)		
50	9,790 (74)	9,000 (77)	7,250 (79)	5,450 (77.5)		
60	9,110 (71)	7,970 (73.5)	6,900 (75.5)	5,100 (74.5)	4,930 (79.5)	
70	8,410 (67.5)	7,120 (70)	6,600 (72)	4,900 (71.5)	4,430 (76.5)	3,610 (80)
80	7,410 (63.5)	6,420 (66.5)	6,080 (68)	4,700 (68)	4,220 (73.5)	3,510 (76.5)
90	6,590 (60)	5,820 (62.5)	5,590 (64)	4,500 (65)	3,950 (70)	3,380 (73)
100	5,900 (56)	5,310 (58.5)	5,170 (60)	4,150 (62)	3,570 (66.5)	3,260 (70)
110	4,820 (52)	4,870 (54.5)	4,800 (55.5)	3,700 (58.5)	3,240 (63)	3,170 (66)
120	4,020 (47.5)	4,240 (50)	4,470 (51)	3,300 (55)	2,950 (59.5)	2,930 (62)
130	3,540 (42.5)	3,770 (45)		2,960 (51)	2,700 (56)	2,720 (58)
140	3,110 (37)	3,340 (39.5)		2,300 (47)	2,470 (51.5)	2,530 (53.5)
150	2,160 (31)	2,190 (33)		1,540 (43)	2,100 (47)	
160	1,230 (22.5)				1,300 (42)	
Minimum boom angle (deg.) for indicated length	16	25	45	28	35	45
Maximum boom length (ft.) at 0 deg. boom angle.		129.6			111.6	

NOTE: () Boom angles are in degrees.

*This capacity is based on maximum boom angle.

A6-829-015394A



148 ft.
(45.0 m)



31 - 56 ft.
(9.4 - 17.1 m)



7,700 lbs.
(3493 kg)



100%



360°



Pounds

(Feet)	31 FT. LENGTH			56 FT. LENGTH		
	1° OFFSET	25° OFFSET	45° OFFSET	1° OFFSET	25° OFFSET	45° OFFSET
25	*11,700 (81.5)					
30	11,700 (81)			*5,820 (81.5)		
35	11,700 (79.5)			5,820 (81)		
40	11,050 (77.5)	9,600 (80.5)		5,820 (80)		
45	10,400 (76)	9,600 (79)	7,250 (81)	5,820 (78.5)		
50	9,790 (74)	9,000 (77)	7,250 (79)	5,450 (77.5)		
60	9,110 (71)	7,970 (73.5)	6,900 (75.5)	5,100 (74.5)	4,930 (79.5)	
70	8,410 (67.5)	7,120 (70)	6,600 (72)	4,900 (71.5)	4,430 (76.5)	3,610 (80)
80	7,410 (63.5)	6,420 (66.5)	6,080 (68)	4,700 (68)	4,220 (73.5)	3,510 (76.5)
90	6,590 (60)	5,820 (62.5)	5,590 (64)	4,500 (65)	3,950 (70)	3,380 (73)
100	5,770 (56)	5,310 (58.5)	5,170 (60)	4,150 (62)	3,570 (66.5)	3,260 (70)
110	3,990 (52)	4,630 (54.5)	4,800 (55.5)	3,700 (58.5)	3,240 (63)	3,170 (66)
120	2,540 (47.5)	2,980 (50)	3,360 (51)	3,300 (55)	2,950 (59.5)	2,930 (62)
130	1,340 (42.5)	1,620 (45)		2,620 (51)	2,700 (56)	2,720 (58)
140				1,540 (47)	2,380 (51.5)	2,530 (53.5)
150					1,310 (47)	
Minimum boom angle (deg.) for indicated length	40	43	45	43	44	45
Maximum boom length (ft.) at 0 deg. boom angle.		93.6			75.6	

NOTE: () Boom angles are in degrees.
*This capacity is based on maximum boom angle.

A6-829-015395A



148 ft.
(45.0 m)



31 - 56 ft.
(9.4 - 17.1 m)



0 lbs.
(0 kg)



100%



360°



Pounds

(Feet)	31 FT. LENGTH			56 FT. LENGTH		
	1° OFFSET	25° OFFSET	45° OFFSET	1° OFFSET	25° OFFSET	45° OFFSET
25	*11,700 (81.5)					
30	11,700 (81)			*5,820 (81.5)		
35	11,700 (79.5)			5,820 (81)		
40	11,050 (77.5)	9,600 (80.5)		5,820 (80)		
45	10,400 (76)	9,600 (79)	7,250 (81)	5,820 (78.5)		
50	9,790 (74)	9,000 (77)	7,250 (79)	5,450 (77.5)		
60	9,110 (71)	7,970 (73.5)	6,900 (75.5)	5,100 (74.5)	4,930 (79.5)	
70	8,410 (67.5)	7,120 (70)	6,600 (72)	4,900 (71.5)	4,430 (76.5)	3,610 (80)
80	7,410 (63.5)	6,420 (66.5)	6,080 (68)	4,700 (68)	4,220 (73.5)	3,510 (76.5)
90	5,740 (60)	5,820 (62.5)	5,590 (64)	4,500 (65)	3,950 (70)	3,380 (73)
100	3,760 (56)	4,640 (58.5)	5,160 (60)	4,150 (62)	3,570 (66.5)	3,260 (70)
110	2,190 (52)	2,830 (54.5)	3,270 (55.5)	3,640 (58.5)	3,240 (63)	3,170 (66)
120		1,350 (50)	1,730 (51)	2,270 (55)	2,950 (59.5)	2,930 (62)
130				1,120 (51)	2,140 (56)	2,720 (58)
140					1,010 (51.5)	1,390 (53.5)
Minimum boom angle (deg.) for indicated length	48	48	49	50	51	51
Maximum boom length (ft.) at 0 deg. boom angle.		75.6			75.6	

NOTE: () Boom angles are in degrees.
*This capacity is based on maximum boom angle.

A6-829-015396A



121 ft.
(36.9 m)



31 - 56 ft.
(9.4 - 17.1 m)



24,000 lbs.
(10 886 kg)



100%



360°



Pounds

(Feet)	31 FT. LENGTH			56 FT. LENGTH		
	1° OFFSET	25° OFFSET	45° OFFSET	1° OFFSET	25° OFFSET	45° OFFSET
20	12,900 (81)					
25	12,900 (80)					
30	12,900 (78.5)	*10,100 (81.5)		11,850 (81)		
35	12,900 (76.5)	10,100 (80)		11,850 (79.5)		
40	12,900 (74.5)	9,890 (78)	7,320 (80.5)	10,800 (77.5)		
45	12,900 (72.5)	9,420 (76)	7,270 (78.5)	9,910 (76)	*5,160 (81.5)	
50	12,900 (70.5)	9,000 (74)	7,060 (76)	9,130 (74.5)	5,160 (80)	
60	12,550 (66)	8,260 (69.5)	6,680 (72)	7,880 (71)	4,930 (76.5)	3,680 (80.5)
70	11,000 (62)	7,650 (65)	6,390 (67)	6,910 (67)	4,540 (73)	3,600 (77)
80	9,800 (57.5)	7,130 (60.5)	6,150 (62.5)	6,130 (63.5)	4,210 (69)	3,430 (73)
90	8,820 (52.5)	6,700 (55.5)	5,920 (57.5)	5,500 (59.5)	3,930 (65.5)	3,280 (68.5)
100	8,010 (47.5)	6,340 (50.5)	5,780 (52)	4,980 (55.5)	3,690 (61)	3,160 (64.5)
110	6,760 (41.5)	6,040 (44.5)		4,530 (51.5)	3,480 (57)	3,080 (59.5)
120	4,980 (35)	5,590 (38)		4,160 (47)	3,300 (52)	2,990 (54.5)
130	3,510 (27)	3,990 (29.5)		3,830 (42)	3,150 (47)	
140	2,250 (14)			3,550 (36)	3,040 (41)	
150				2,690 (29.5)	2,960 (33.5)	
160				1,720 (20.5)		
Minimum boom angle (deg.) for indicated length	0	25	45	0	25	45
Maximum boom length (ft.) at 0 deg. boom angle.		120.6			111.6	

NOTE: () Boom angles are in degrees.
*This capacity is based on maximum boom angle.

A6-829-015427A



121 ft.
(36.9 m)



31 - 56 ft.
(9.4 - 17.1 m)



7,700 lbs.
(3493 kg)



100%



360°



Pounds

(Feet)	31 FT. LENGTH			56 FT. LENGTH		
	1° OFFSET	25° OFFSET	45° OFFSET	1° OFFSET	25° OFFSET	45° OFFSET
20	12,900 (81)					
25	12,900 (80)					
30	12,900 (78.5)	*10,100 (81.5)		11,850 (81)		
35	12,900 (76.5)	10,100 (80)		11,850 (79.5)		
40	12,900 (74.5)	9,890 (78)	7,320 (80.5)	10,800 (77.5)		
45	12,900 (72.5)	9,420 (76)	7,270 (78.5)	9,910 (76)	*5,160 (81.5)	
50	12,900 (70.5)	9,000 (74)	7,060 (76)	9,130 (74.5)	5,160 (80)	
60	12,550 (66)	8,260 (69.5)	6,680 (72)	7,880 (71)	4,930 (76.5)	3,680 (80.5)
70	11,000 (62)	7,650 (65)	6,390 (67)	6,910 (67)	4,540 (73)	3,600 (77)
80	9,750 (57.5)	7,130 (60.5)	6,150 (62.5)	6,130 (63.5)	4,210 (69)	3,430 (73)
90	6,900 (52.5)	6,700 (55.5)	5,920 (57.5)	5,500 (59.5)	3,930 (65.5)	3,280 (68.5)
100	4,700 (47.5)	5,640 (50.5)	5,780 (52)	4,980 (55.5)	3,690 (61)	3,160 (64.5)
110	2,950 (41.5)	3,710 (44.5)		4,530 (51.5)	3,480 (57)	3,080 (59.5)
120	1,530 (35)	2,130 (38)		3,220 (47)	3,300 (52)	2,990 (54.5)
130				1,960 (42)	3,060 (47)	
140					1,810 (41)	
Minimum boom angle (deg.) for indicated length	29	35	45	37	39	45
Maximum boom length (ft.) at 0 deg. boom angle.		93.6			75.6	

NOTE: () Boom angles are in degrees.

*This capacity is based on maximum boom angle.

A6-829-015428A



121 ft.
(36.9 m)



31 - 56 ft.
(9.4 - 17.1 m)



0 lbs.
(0 kg)



100%



360°



Pounds

(Feet)	31 FT. LENGTH			56 FT. LENGTH		
	1° OFFSET	25° OFFSET	45° OFFSET	1° OFFSET	25° OFFSET	45° OFFSET
20	12,900 (81)					
25	12,900 (80)					
30	12,900 (78.5)	*10,100 (81.5)		11,850 (81)		
35	12,900 (76.5)	10,100 (80)		11,850 (79.5)		
40	12,900 (74.5)	9,890 (78)	7,320 (80.5)	10,800 (77.5)		
45	12,900 (72.5)	9,420 (76)	7,270 (78.5)	9,910 (76)	*5,160 (81.5)	
50	12,900 (70.5)	9,000 (74)	7,060 (76)	9,130 (74.5)	5,160 (80)	
60	12,550 (66)	8,260 (69.5)	6,680 (72)	7,880 (71)	4,930 (76.5)	3,680 (80.5)
70	10,500 (62)	7,650 (65)	6,390 (67)	6,910 (67)	4,540 (73)	3,600 (77)
80	7,150 (57.5)	7,130 (60.5)	6,150 (62.5)	6,130 (63.5)	4,210 (69)	3,430 (73)
90	4,630 (52.5)	5,810 (55.5)	5,920 (57.5)	5,500 (59.5)	3,930 (65.5)	3,280 (68.5)
100	2,690 (47.5)	3,630 (50.5)	3,920 (52)	4,600 (55.5)	3,690 (61)	3,160 (64.5)
110	1,150 (41.5)	1,900 (44.5)		2,940 (51.5)	3,480 (57)	3,080 (59.5)
120				1,590 (47)	2,910 (52)	2,990 (54.5)
130					1,560 (47)	
Minimum boom angle (deg.) for indicated length	37	41	45	43	44	45
Maximum boom length (ft.) at 0 deg. boom angle.		75.6			66.6	

NOTE: () Boom angles are in degrees.
*This capacity is based on maximum boom angle.

A6-829-015429A

Travel proposal

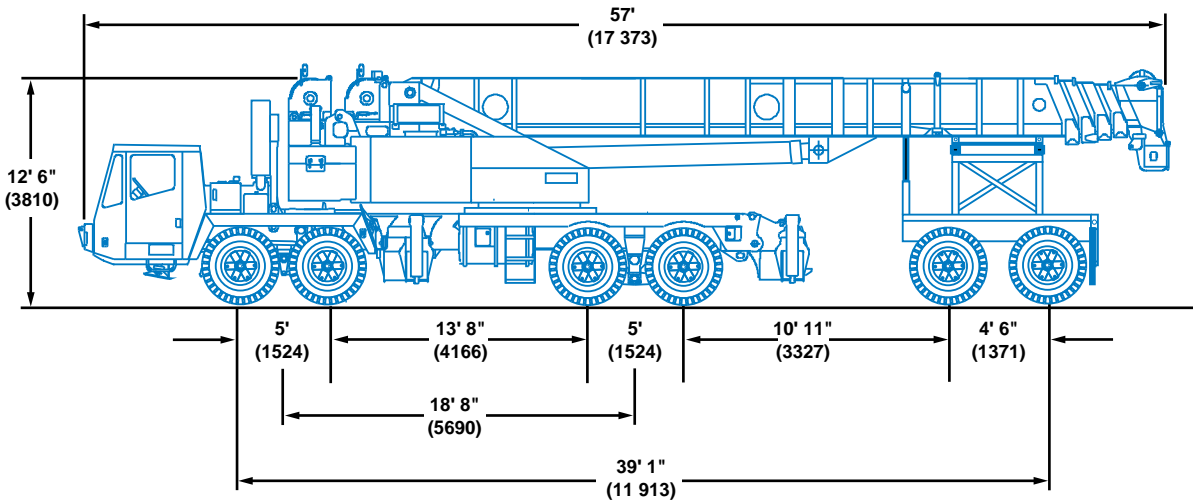

Note: () Reference dimensions in mm

FRONT
42,653 lbs.
(19 347 kg)

REAR
44,132 lbs.
(20 018 kg)

DOLLY
32,117 lbs.
(14 568 kg)

GVW
118,902 lbs.
(53 934 kg)

INSTALLED

- 148 ft. (45.0 m) 5-section boom
- 5,700 lbs. (2586 kg) two axle boom dolly
- Main and auxiliary hoist w/rope
- 56 ft. (17.0 m) bi-fold boom extension
- 10 ton (560 lbs.) ball on carrier
- 65 ton (1,040 lbs.) block at boom point.
- Boom extended 0 ft. (0 m) w/aux. nose
- Front and rear O/R boxes
- 175 lbs. (79.4 kg) operator

REMOVED

- Counterweight (24,000 lbs. [10 900 kg])

TIRES

Front: 4X 445/65R22.5

Rear: 8X 14:00R20

Dolly: 8X 11-22.5

Note: Weights may vary 3% due to manufacturing tolerances.

Rated Lifting Capacities

IMPORTANT NOTES:

WARNING: THIS CHART IS ONLY A GUIDE.

The notes below are for illustration only and should not be relied upon to operate the crane. The individual crane's load chart, operating instructions and other instruction plates must be read and understood prior to operating the crane.

1. All rated loads meet ANSI/ASME B30.5, Mobile and Locomotive Cranes. Testing and development were performed to SAEJ1063, Cantilevered Boom Crane Structures - Method of Test, and SAEJ765 Crane Stability Test Code.

2. Rated loads include the weight of hookblock, slings and auxiliary lifting devices and their weights shall be subtracted from the listed rating to obtain the net load to be lifted. When more than the minimum required hoist reeving is used, the additional rope weight shall be considered part of the load to be handled.





































3. Capacities appearing above the bold line are based on structural strength. Tipping should not be relied upon as a capacity indication.

4. The machine shall be leveled on a firm supporting surface. Depending on the nature of the supporting surface, it may be necessary to have structural supports under the outrigger floats or tires to spread the load to a larger bearing surface.

5. When either boom length or radius or both are between values listed, the smallest load shown at either the next larger radius or next longer or shorter boom length shall be used.

6. For outrigger operation, outriggers shall be properly extended with tires raised free of crane weight before operating the boom or lifting loads.

Symbols Glossary

	Frame		Steering
	Outriggers		Transmission
	Outrigger Controls		Axles
	Engine		Brakes
	Fuel Tank Capacity		Tires
	Electrical System		Suspension
	Drive		Rotation
	Lights		Boom Elevation
	Cab		Swing
	Boom		Counterweight
	Fixed Swingaway		Oil
	Tele-Swingaway		Hydraulic System
	Jib		Hoist
	Boom Nose		Radius
	Boom Extension		Boom Length
	Speed		Hookblock
	Grade		Gear
	Lattice Extension		Luffing Jib

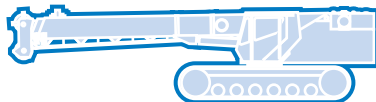
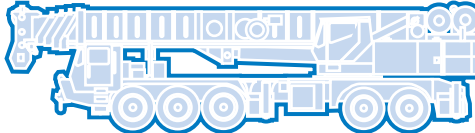
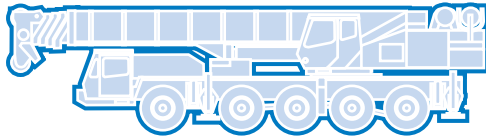
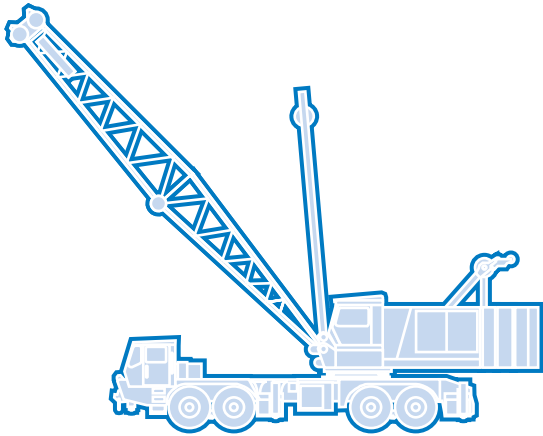

Grove Worldwide – World Headquarters

Grove North America
1565 Buchanan Trail East
P.O. Box 21
Shady Grove, Pennsylvania 17256, U.S.A.
Tel: [Int + 1] (717) 597-8121
Fax: [Int + 1] (717) 597-4062
Western Hemisphere, Asia/Pacific

Grove Europe Limited*

Sunderland SR4 6TT, England
Tel: [Int + 44] 191 565-6281
Fax: [Int + 44] 191 564-0442
Europe, Africa, Middle East

Grove Europe Limited*

P.O. Box No. 268
4A Kimber Road
Abingdon, Oxfordshire, OX141SG
Tel: [Int + 44] 1235 55-3184
Fax: [Int + 44] 1235 55-3218
*Grove Europe Limited, Registered in England,
Number 1845128, Registered office, Crown Works,
Pallion, Sunderland, Tyne & Wear, England SR4 6TT

Deutsche Grove GmbH

Sales and Service
Helmholtzstrasse 12, Postfach 5026
D-40750 Langenfeld, Germany
Tel: [Int + 49] (2173) 8909-0
Fax: [Int + 49] (2173) 8909-30

Wilhelmshaven Works

Industriegelände West, Postfach 1853
D-26358 Wilhelmshaven, Germany
Tel: [Int + 49] (4421) 294-0
Fax: [Int + 49] (4421) 294-301

Grove France S.A.

16, chaussée Jules-César, 95520 OSNY
B.P. 203, 95523 CERGY PONTOISE CEDEX
France
Tel: [Int + 33] (1) 30313150
Int: [Int + 33] (1) 30386085

Grove Asia/Pacific - Regional Office

171 Chin Swee Road
#06-01 San Centre
Singapore 0316
Tel: [Int + 65] 536-6112
Fax: [Int + 65] 536-6119
Asia/Pacific, Near East

Grove China - Representative Office

Beijing Suite 6074
No. 33 East Chang An Avenue
Beijing, 100004, China
Tel: [Int + 86] (10) 513-7766
Fax: [Int + 86] (10) 513-7307

Grove Product Support

Western Hemisphere, Asia/Pacific
1086 Wayne Avenue
Chambersburg, Pennsylvania USA
Tel: [Int + 1] (717) 263-5100
Fax: [Int + 1] (717) 267-0404

Europe, Africa, Middle East
Sunderland SR4 6TT, England
Tel: [Int + 44] 191 565-6281
Parts Fax: [Int + 44] 191 510-9242
Service Fax: [Int + 44] 191 510-9560

<http://www.grovetworldwide.com>

Constant improvement and engineering progress make it necessary that we reserve the right to make specification, equipment, and price changes without notice. Illustrations shown may include optional equipment and accessories and may not include all standard equipment.

Distributed By: