

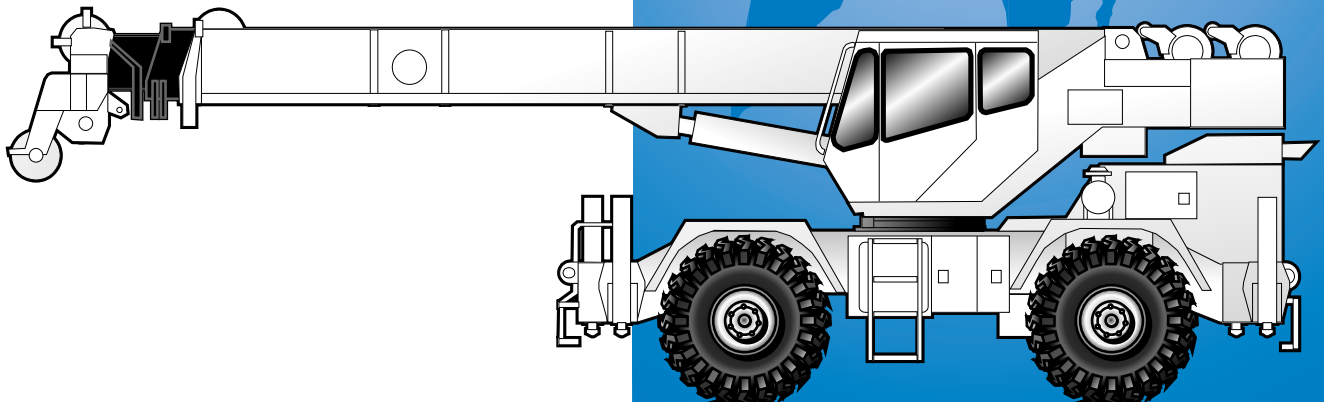

**GROVE**<sup>®</sup>  
**CRANE**

# RT500D



**Rough Terrain Hydraulic Crane**

# Dimensions

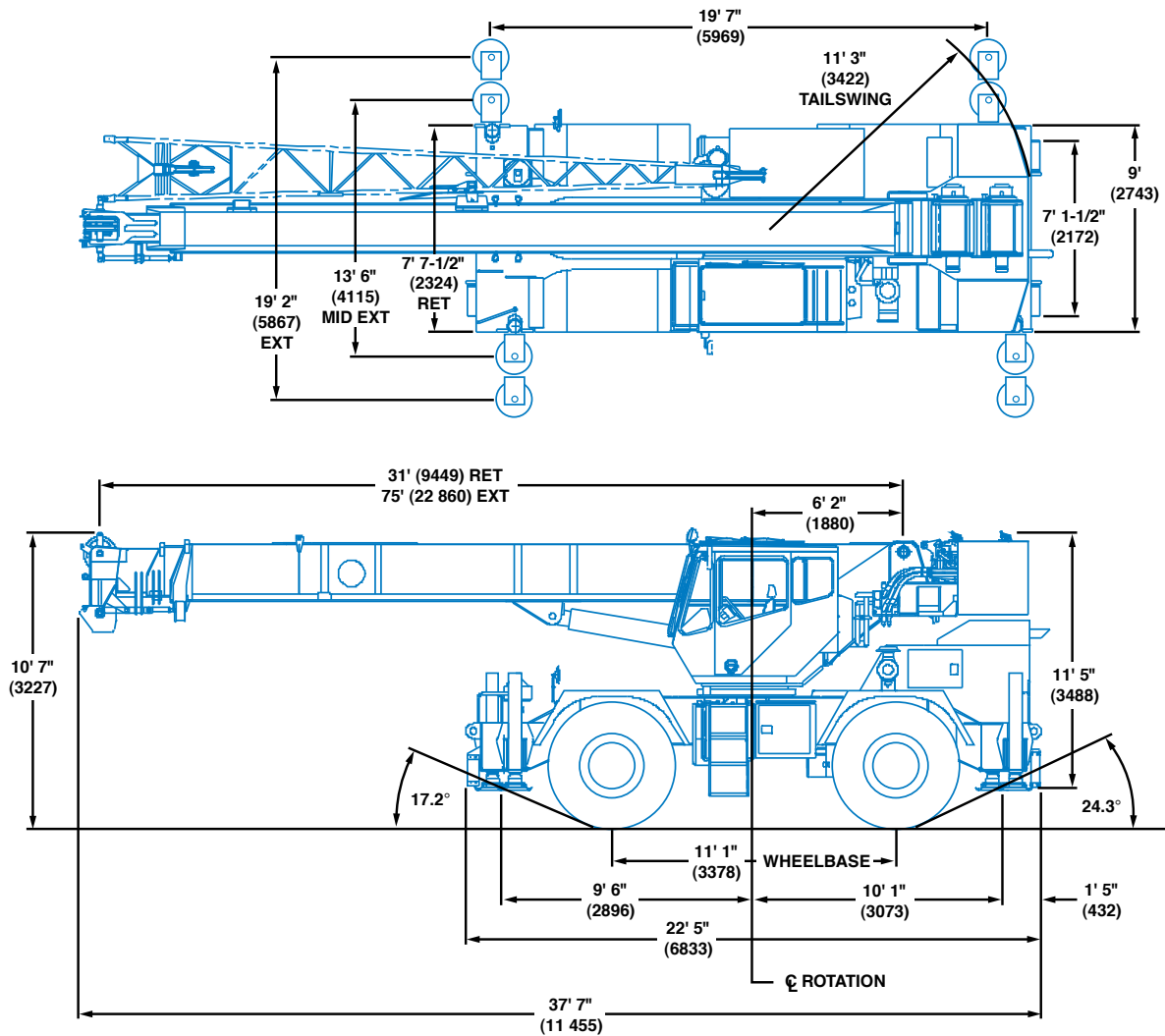

Note: ( ) Reference dimensions in mm

Turning Radius . . . . . 18' 2" (5532 mm)

Front Axle Load . . . . . 26,400 lbs. (11 975 kg)

Rear Axle Load . . . . . 28,633 lbs. (12 988 kg)

Gross Vehicle Weight . . . . . 55,033 lbs. (24 963 kg)

# Working range



31 - 75 ft.  
(9.5 - 22.8 m)

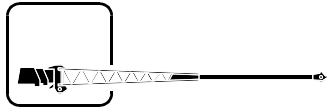

25 - 43 ft.  
(7.6 - 13 m)



5,600 lbs.  
(2540 kg)

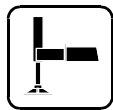

100%

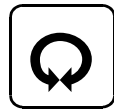

360°

FEET

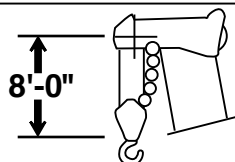
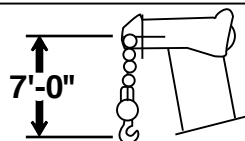
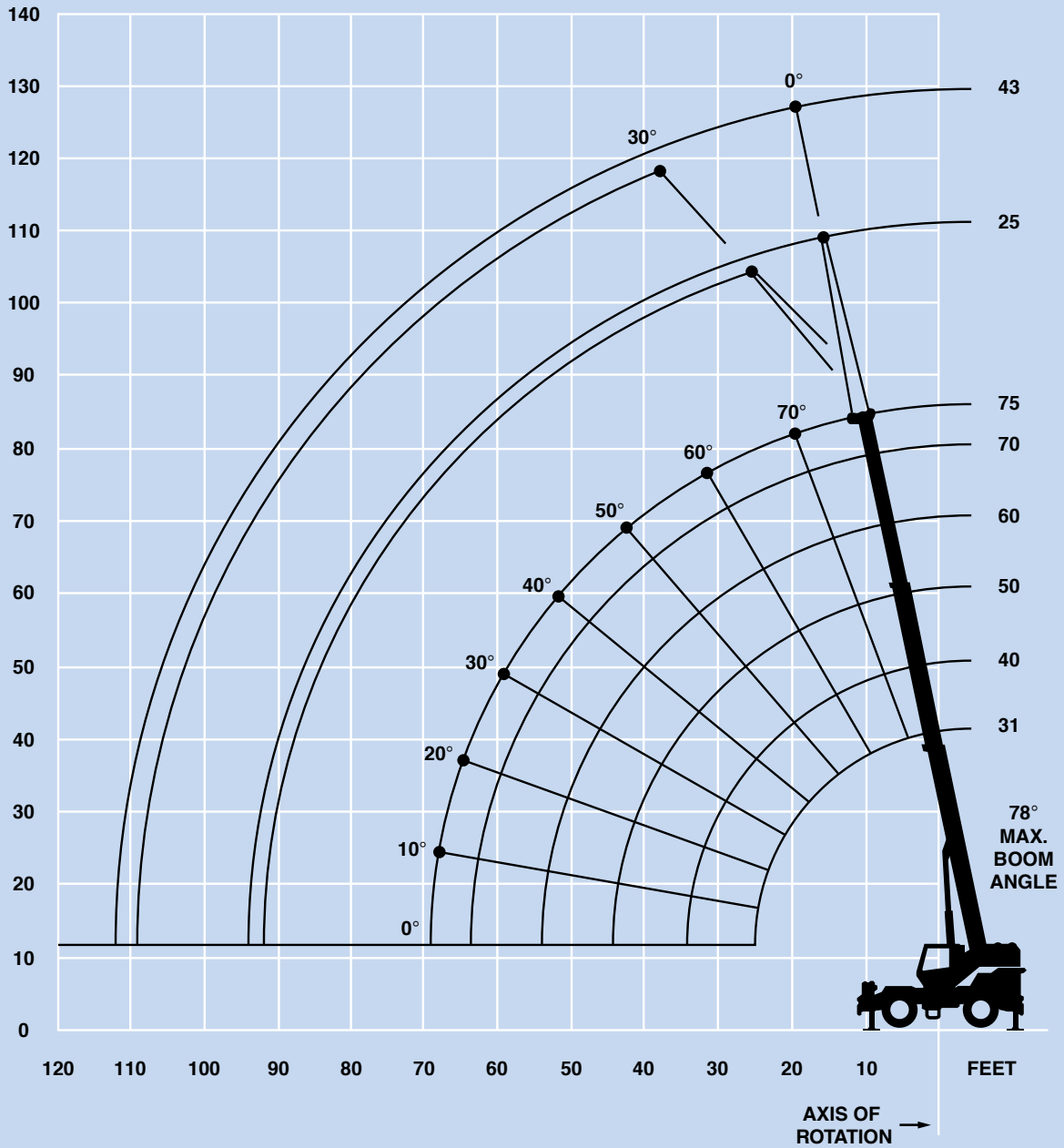

DIMENSIONS ARE FOR LARGEST GROVE FURNISHED HOOK BLOCK AND HEADACHE BALL, WITH ANTI-TWO BLOCK ACTIVATED.

# Superstructure specifications

## Boom

31 ft. - 75 ft. (9.5 m - 22.8 m) three-section, full power boom. Maximum tip height: 83 ft. 8 in. (25.5 m).

## Fixed Swingaway Extension

25 ft. (7.6 m) lattice swingaway extension. Non-offsettable. Stows alongside base boom section. Maximum tip height: 108 ft. (33 m).

## \*Optional Fixed Swingaway Extension

25 ft. (7.6 m) lattice swingaway extension. Offsettable at 0° and 30°. Stows alongside base boom section. Maximum tip height: 108 ft. (33 m).

## \*Optional Telescopic Swingaway Extension

25 ft. - 43 ft. (7.6 m - 13 m) telescoping lattice swingaway extension. Offsettable at 0° and 30°. Stows alongside base boom section. Maximum tip height: 126 ft. 10 in. (38.7 m).

## Boom Nose

Four steel sheaves mounted on heavy duty tapered roller bearings with removable pin-type rope guards. Quick reeve type boom nose. \*Optional removable auxiliary boom nose with removable pin type rope guard.

## Boom Elevation

One double acting hydraulic cylinder with integral holding valve provides elevation from -1° to 78°.

## Load Moment & Anti-Two Block System

Standard load moment and anti-two block system with audio-visual warning and control lever lockout. These systems provide electronic display of boom angle, length, radius, tip height, relative load moment, maximum permissible load, load indication and warning of impending two-block condition.

## Cab

Full vision, all steel fabricated with acoustical lining and tinted safety glass throughout. Deluxe seat incorporates armrest mounted hydraulic single-axis controllers. Dash panel incorporates gauges for all engine functions. Other standard features include: hot water heater, cab circulating air fan, telescoping tilt wheel, sliding side and rear windows, opening skylight, skylight sunscreen, electric windshield wash/wipe, electric skylight wiper, fire extinguisher, seat belt and ashtray/cupholder.

## Swing

Planetary swing with foot applied multi-disc brake. Spring applied, hydraulically released swing brake and plunger-type, one position, mechanical house lock operated from cab. 360° mechanical swing lock. Maximum speed: 3.0 RPM.

## Counterweight

5,600 lbs. (2540 kg) integral with superstructure. 910 lbs. (413 kg) slab in place of auxiliary hoist.

## Hydraulic System

Five main gear pumps with a combined capacity of 172.4 GPM (652 LPM). Pump disconnect with engine jogging switch. Maximum operating pressure: 3500 psi (241 bar).

Three individual valve banks.

Return line type filter with full flow by-pass protection and service indicator. Replaceable cartridge with micron filtration rating of 5/12/16.

120 gallon (454 L) reservoir.

Remote mounted oil cooler with thermostatically controlled electric motor driven fan/air to oil.

System pressure test ports with quick release type fittings for each circuit.

## Hoist Specifications Main and Auxiliary Hoist

Planetary reduction with automatic spring applied multi-disc brake. Grooved drum. Electronic hoist drum rotation indicator and hoist drum cable followers.

Maximum Single Line Pull:	10,591 lbs. (4804 kg)
Maximum Single Line Speed:	450 FPM (137 m/min)
Maximum Permissible Line Pull:	9,080 lbs. (4118 kg)
Rope Diameter:	5/8" (16 mm)
Rope Length:	450 ft. (137 m)
Maximum Rope Stowage:	534 ft. (163 m)

*\*Denotes optional equipment*

# Carrier specifications

## Chassis

Box section frame fabricated from high-strength, low alloy steel. Integral outrigger housings and front/rear towing and tie down lugs. Built in hookblock and headache ball stowage.

## Outrigger System

Four hydraulic telescoping single-stage double box beam outriggers with inverted jacks and integral holding valves. Three position setting. All steel fabricated, quick release type square outrigger floats, 16.5 in. (419 mm) diameter. Maximum outrigger pad load: 49,100 lbs. (24 630 kg).

## Outrigger Controls

Controls and crane level indicator located in cab.

## Engine

Cummins 6BT 5.9 L diesel, six cylinders, turbocharged, 145 bhp (108 kW) (Gross) @ 2,200 RPM. Maximum torque: 400 ft. lbs. (542 Nm) @ 1,600 RPM.

## \*Optional Engine

Caterpillar 3116TA diesel, six cylinders, turbocharged, 145 bhp (108 kW) (Gross) @ 2,200 RPM. Maximum torque: 442 ft. lbs. (599 Nm) @ 1,450 RPM.

## Fuel Tank Capacity

60 gallons (227 L)

## Transmission

Full powershift with 8 forward and 4 reverse speeds. Rear axle disconnect for 4 x 2 travel.

## Electrical System

Two 12 V - maintenance free batteries. 24 V starting and lighting. Battery disconnect switch and power slave receptacle (jump start aid).

## Drive

4 x 4.

## Steering

Fully independent power steering:  
Front: Full hydraulic steering wheel controlled.  
Rear: Full hydraulic switch controlled.  
Provides infinite variations of 4 main steering modes: front only, rear only, crab and coordinated. Rear steer indicating gauge and automatic steering reversal.

## Axles

Front: Drive/steer with differential and planetary reduction hubs rigid mounted to frame.  
Rear: Drive/steer with differential and planetary reduction hubs pivot mounted to frame.

## Oscillation Lockouts

Automatic full hydraulic lockouts on rear axle permit oscillation only with boom centered over the front.

## Brakes

Full hydraulic split circuit disc-type brakes operating on all wheels. Spring-applied, hydraulically released transmission-mounted parking brake.

## Tires

20.5 x 25 - 24PR bias earthmover type.  
\*20.5R25 Michelin radials.  
\*16.00 x 25 - 28PR bias earthmover type.

## Lights

Full lighting package including turn indicators, head, tail, brake and hazard warning lights.

## Maximum Speed

24 MPH (39 kph).

## Gradeability (Theoretical)

74% (Based on 54,962 lbs. [24 930 kg] GVW) 20.5 x 25 tires, pumps disengaged, 75 ft. (22.8 m) boom, and 25 ft. (7.6 m) swingaway.

## Miscellaneous Standard Equipment

Full width steel fenders, dual rear view mirrors, hookblock tiedown, electronic back-up alarm, headache ball stowage, tool box compartment, light package, front stowage well, tachometer, cold start aid (less canister), rear wheel position indicator, hot water heater, hoist mirrors, engine distress A/V warning system. Auxiliary hoist control valve arrangement (less hoist), 360° positive swing lock and automatic steering reversal.

## \*Optional Equipment

*Auxiliary hoist	*High speed glide system
*Boom mounted worklights	*Air conditioning
*360° flashing light	*Dual axis joystick controllers
*Cab spotlight	*LMI light bar (internal or external)
*Engine block heater	*Emergency steer pump
*Hookblocks (quick reeve type)	*Automatic steering control system
*Tow winch - front mounted maximum pull: 15,000 lbs. (6804 kg); maximum speed: 92 ft./min. (28 m/min).	*Headache ball
*Spare wheel assembly	*Automatic grease system for turntable bearing
*Tool kit	*3rd wrap indicators (main or auxiliary)
*Pintle hook front/rear	*Worklight, hoist mounted
	*Aluminum fender decking

*\*Denotes optional equipment*



31 - 75 ft.  
(9.5 - 22.8 m)



5,600 lbs.  
(2540 kg)



100%



360°



Pounds

Feet	31	40	50	60	70	75	25 ft. Ext. & 75 ft. 100
10	60,000 (63.5)	53,850 (70)	45,500 (74.5)				
12	52,150 (59)	48,950 (67)	41,950 (72.5)	36,300 (76)			
15	45,150 (52)	43,250 (62)	37,450 (68.5)	34,200 (73)	32,100 (76)	30,000 (77.5)	
20	32,950 (38)	32,950 (53)	31,850 (62)	28,100 (67.5)	27,000 (71.5)	27,000 (73.5)	*15,000 (78)
25	24,800 (10)	24,800 (43)	24,800 (55)	23,500 (62.5)	23,500 (67)	23,500 (69)	13,300 (75.5)
30		19,600 (29.5)	19,600 (47)	19,600 (56.5)	19,600 (62.5)	19,600 (65)	11,850 (72)
35			15,850 (38)	15,850 (50.5)	15,850 (57.5)	15,850 (60.5)	10,700 (69)
40			12,650 (26)	12,650 (43.5)	12,650 (52.5)	12,650 (55.5)	9,730 (66)
45				10,300 (35)	10,300 (46.5)	10,300 (50.5)	9,080 (62.5)
50				8,610 (24.5)	8,610 (40.5)	8,610 (45)	8,630 (59.5)
55					7,260 (33)	7,260 (39)	7,930 (55.5)
60					6,170 (23)	6,170 (32)	6,900 (52)
65						5,290 (22)	5,940 (48)
70							5,130 (44)
75							4,420 (39)
80							3,800 (34)
85							3,270 (27.5)
90							2,810 (19.5)
Minimum boom angle (deg.) for indicated length (no load)						0	0
Maximum boom length (ft.) at 0 degree boom angle (no load)						75	100

NOTE: ( ) Boom angles are in degrees.  
\*This capacity is based upon maximum boom angle.

A6-829-013067A

Boom Angle	31	40	50	60	70	75
0°	24,700 (25)	16,650 (33.8)	10,800 (43.8)	7,550 (53.8)	5,480 (63.8)	4,710 (68.8)

NOTE: ( ) Reference radii are in feet.

A6-829-013191



31 - 75 ft.  
(9.5 - 22.8 m)



5,600 lbs.  
(2540 kg)



50%  
13' 6" Spread



360°



Pounds

Feet	31	40	50	60	70	75	25 ft. Ext. & 75 ft. 100
10	60,000 (63.5)	53,850 (70)	45,500 (74.5)				
12	50,950 (59)	48,950 (67)	41,950 (72.5)	36,300 (76)			
15	41,050 (52)	38,850 (62)	36,800 (68.5)	34,200 (73)	32,100 (76)	30,000 (77.5)	
20	25,300 (38)	25,250 (53)	24,250 (62)	23,300 (67.5)	22,500 (71.5)	22,100 (73.5)	*15,000 (78)
25	17,200 (10)	17,200 (43)	17,200 (55)	17,000 (62.5)	16,500 (67)	16,250 (69)	13,300 (75.5)
30		12,700 (29.5)	12,700 (47)	12,700 (56.5)	12,700 (62.5)	12,550 (65)	11,850 (72)
35			9,810 (38)	9,810 (50.5)	9,810 (57.5)	9,810 (60.5)	10,050 (69)
40			7,780 (26)	7,780 (43.5)	7,780 (52.5)	7,780 (55.5)	8,260 (66)
45				6,280 (35)	6,280 (46.5)	6,280 (50.5)	6,870 (62.5)
50				5,120 (24.5)	5,120 (40.5)	5,120 (45)	5,770 (59.5)
55					4,210 (33)	4,210 (39)	4,870 (55.5)
60					3,470 (23)	3,470 (32)	4,130 (52)
65						2,850 (22)	3,450 (48)
70							2,880 (44)
75							2,400 (39)
80							1,980 (34)
85							1,620 (27.5)
90							1,300 (19.5)
Minimum boom angle (deg.) for indicated length (no load)						0	0
Maximum boom length (ft.) at 0 degree boom angle (no load)						75	100

NOTE: ( ) Boom angles are in degrees.  
\*This capacity is based upon maximum boom angle.

Boom Angle	31	40	50	60	70	75
0°	17,150 (25)	10,350 (33.8)	6,590 (43.8)	4,400 (53.8)	2,980 (63.8)	2,450 (68.8)

NOTE: ( ) Reference radii in feet.

A6-829-013133



31 - 75 ft.  
(9.5 - 22.8 m)



5,600 lbs.  
(2540 kg)



0%  
7' 7-1/2" Spread



360°



Pounds

Feet	31	40	50	60	70	75
10	33,950 (63.5)	31,950 (70)	29,950 (74.5)			
12	25,800 (59)	25,200 (67)	23,850 (72.5)	22,650 (76)		
15	17,800 (52)	17,800 (62)	17,800 (68.5)	17,200 (73)	16,450 (76)	16,150 (77.5)
20	11,050 (38)	11,050 (53)	11,050 (62)	11,050 (67.5)	11,050 (71.5)	11,050 (73.5)
25	7,470 (10)	7,470 (43)	7,470 (55)	7,470 (62.5)	7,470 (67)	7,470 (69)
30		5,450 (29.5)	5,450 (47)	5,450 (56.5)	5,450 (62.5)	5,450 (65)
35			4,070 (38)	4,070 (50.5)	4,070 (57.5)	4,070 (60.5)
40			3,080 (26)	3,080 (43.5)	3,080 (52.5)	3,080 (55.5)
45				2,330 (35)	2,330 (46.5)	2,330 (50.5)
50				1,740 (24.5)	1,740 (40.5)	1,740 (45)
55					1,260 (33)	1,260 (39)
Minimum boom angle (deg.) for indicated length (no load)						24
Maximum boom length (ft.) at 0 degree boom angle (no load)						70

NOTE: ( ) Boom angles are in degrees.

Boom Angle	31	40	50	60
0°	7,440 (25)	4,350 (33.8)	2,490 (43.8)	1,360 (53.8)

NOTE: ( ) Reference radii in feet.

A6-829-013134A



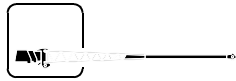

25 - 43 ft.  
(7.6 - 13 m)



5,600 lbs.  
(2540 kg)



100%



360°



Feet	**25 ft. LENGTH		43 ft. LENGTH	
	0° OFFSET	30° OFFSET	0° OFFSET	30° OFFSET
20	*15,000 (78)			
25	13,300 (76)		*6,520 (78)	
30	11,850 (73)	*4,900 (78)	5,740 (77)	
35	10,700 (69.5)	4,680 (75.5)	5,130 (74.5)	
40	9,730 (66.5)	4,480 (72)	4,640 (72)	
45	9,080 (63.5)	4,310 (69)	4,240 (69)	*2,470 (78)
50	8,630 (60)	4,160 (65.5)	3,900 (66.5)	2,360 (75.5)
55	7,440 (56.5)	4,030 (62)	3,610 (63.5)	2,270 (72.5)
60	6,250 (53)	3,920 (58)	3,360 (60.5)	2,180 (69.5)
65	5,270 (49)	3,830 (54)	3,150 (58)	2,100 (66.5)
70	4,460 (44.5)	3,760 (49.5)	2,960 (54.5)	2,040 (63)
75	3,770 (40)	3,720 (44.5)	2,800 (51.5)	1,980 (59.5)
80	3,180 (35)	3,180 (39)	2,650 (48)	1,930 (56)
85	2,670 (28.5)		2,520 (44.5)	1,890 (52)
90	2,220 (20.5)		2,400 (40.5)	1,860 (48)
95			2,300 (36)	1,840 (43)
100			2,200 (31)	
105			2,070 (24.5)	
110			1,740 (15)	

NOTE: ( ) Boom angles are in degrees.  
 \*This capacity is based upon maximum boom angle.  
 \*\*25 ft. capacities are also applicable to fixed offsettable ext.  
 However, the LMI codes will change for 0° and 30° offset, respectively.

A6-829-013068A

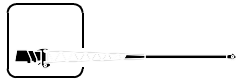

25 - 43 ft.  
(7.6 - 13 m)



5,600 lbs.  
(2540 kg)



50%  
13' 6" Spread



360°



Pounds

Feet	**25 ft. LENGTH		43 ft. LENGTH	
	0° OFFSET	30° OFFSET	0° OFFSET	30° OFFSET
20	*15,000 (78)			
25	13,300 (76)		*6,520 (78)	
30	11,850 (73)	*4,900 (78)	5,740 (77)	
35	9,450 (69.5)	4,680 (75.5)	5,130 (74.5)	
40	7,650 (66.5)	4,480 (72)	4,640 (72)	
45	6,270 (63.5)	4,310 (69)	4,240 (69)	*2,470 (78)
50	5,170 (60)	4,160 (65.5)	3,900 (66.5)	2,360 (75.5)
55	4,270 (56.5)	4,030 (62)	3,610 (63.5)	2,270 (72.5)
60	3,500 (53)	3,500 (58)	3,360 (60.5)	2,180 (69.5)
65	2,820 (49)	2,820 (54)	3,150 (58)	2,100 (66.5)
70	2,240 (44.5)	2,240 (49.5)	2,960 (54.5)	2,040 (63)
75	1,750 (40)	1,750 (44.5)	2,540 (51.5)	1,980 (59.5)
80	1,330 (35)	1,330 (39)	2,140 (48)	1,930 (56)
85			1,790 (44.5)	1,790 (52)
90			1,470 (40.5)	1,470 (48)
95			1,160 (36)	1,160 (43)

NOTE: ( ) Boom angles are in degrees.

\*This capacity is based upon maximum boom angle.

\*\*25 ft. capacities are also applicable to fixed offsettable ext.

However, the LMI codes will change for 0° and 30° offset, respectively.

A6-829-013196A



31 - 75 ft.  
(9.5 - 22.8 m)



5,600 lbs.  
(2540 kg)



20.5 x 25  
24 Ply Tires  
Stationary



360°



Pounds

Feet	31	40	50	60	70	75
10	25,100 (63.5)	25,100 (70)				
12	21,000 (59)	21,000 (67)				
15	14,700 (52)	14,700 (62)				
20	9,310 (38)	9,310 (53)	9,310 (62)	9,310 (67)		
25	6,440 (10)	6,440 (43)	6,440 (55)	6,440 (61.5)	6,440 (66.5)	6,440 (68)
30		4,630 (29.5)	4,630 (47)	4,630 (56)	4,630 (61.5)	4,630 (64)
35			3,390 (38)	3,390 (49.5)	3,390 (57)	3,390 (59.5)
40			2,490 (26)	2,490 (42.5)	2,490 (51.5)	2,490 (54.5)
45				1,810 (34.5)	1,810 (46)	1,810 (49.5)
50				1,280 (23.5)	1,280 (39.5)	1,280 (44.5)

NOTE: ( ) Boom angles are in degrees.

A6-829-013183

Boom  
Angle

	31	40	50
0°	6,420 (25)	3,640 (33.8)	1,960 (43.8)

NOTE: ( ) Reference radii in feet.

A6-829-013191



31 - 75 ft.  
(9.5 - 22.8 m)



5,600 lbs.  
(2540 kg)



20.5 x 25  
24 Ply Tires  
Stationary



Defined Arc  
Over Front  
±6°



Pounds

Feet	31	40	50	60	70	75
10	30,450 (63.5)	30,450 (70)				
12	26,300 (59)	26,300 (67)				
15	21,700 (52)	21,700 (62)				
20	16,500 (38)	16,500 (53)	16,500 (62)	16,500 (67)		
25	11,500 (10)	11,500 (43)	11,500 (55)	11,500 (61.5)	11,500 (66.5)	11,500 (68)
30		8,520 (29.5)	8,520 (47)	8,520 (56)	8,520 (61.5)	8,520 (64)
35			6,550 (38)	6,550 (49.5)	6,550 (57)	6,550 (59.5)
40			5,150 (26)	5,150 (42.5)	5,150 (51.5)	5,150 (54.5)
45				4,090 (34.5)	4,090 (46)	4,090 (49.5)
50				3,280 (23.5)	3,280 (39.5)	3,280 (44.5)
55					2,620 (32)	2,620 (38)
60					2,090 (22)	2,090 (31)
65						1,650 (21)

NOTE: ( ) Boom angles are in degrees.

A6-829-013182

Boom  
Angle

	31	40	50	60	70	75
0°	11,450 (25)	6,950 (33.8)	4,320 (43.8)	2,760 (53.8)	1,740 (63.8)	1,350 (68.8)

NOTE: ( ) Reference radii in feet.

A6-829-013191

THIS CHART IS ONLY A GUIDE AND SHOULD NOT BE USED TO OPERATE THE CRANE. The individual crane's load chart, operating instructions and other instructional plates must be read and understood prior to operating the crane.



31 -75 ft.  
(9.5 - 22.8 m)



5,600 lbs.  
(2540 kg)



Pick & Carry  
Up to 2.5 MPH



Boom Centered  
Over Front



Pounds

Feet	31	40	50	60	70	75
10	26,150 (63.5)	26,150 (70)	26,150 (74.5)			
12	22,750 (59)	22,750 (67)	22,750 (72)	22,750 (75.5)		
15	18,800 (52)	18,800 (62)	18,800 (68.5)	18,800 (72.5)		
20	14,300 (38)	14,300 (53)	14,300 (62)	14,300 (67)	14,300 (71)	14,300 (72.5)
25	11,250 (10)	11,250 (43)	11,250 (55)	11,250 (61.5)	11,250 (66.5)	11,250 (68)
30		8,520 (29.5)	8,520 (47)	8,520 (56)	8,520 (61.5)	8,520 (64)
35			6,550 (38)	6,550 (49.5)	6,550 (57)	6,550 (59.5)
40			4,490 (26)	4,490 (42.5)	4,490 (51.5)	4,490 (54.5)
45				3,620 (34.5)	3,620 (46)	3,620 (49.5)
50				2,920 (23.5)	2,920 (39.5)	2,920 (44.5)
55					2,320 (32)	2,320 (38)
60					1,820 (22)	1,820 (31)
65						1,390 (21)

NOTE: ( ) Boom angles are in degrees

A6-829-013184

Boom Angle	31	40	50	60	70	75
0°	11,250 (25)	6,950 (33.8)	3,810 (43.8)	2,450 (53.8)	1,480 (63.8)	1,100 (68.8)

NOTE: ( ) Reference radii in feet.

A6-829-013191

# Rated lifting capacities

## NOTES FOR LIFTING CAPACITIES

### WARNING: THIS CHART IS ONLY A GUIDE.

The notes below are for illustration only and should not be relied upon to operate the crane. The individual crane's load chart, operating instructions and other instruction plates must be read and understood prior to operating the crane.

1. All rated loads meet ANSI/ASME B30.5, Mobile and Locomotive Cranes. Testing and development were performed to SAEJ1063, Cantilevered Boom Crane Structures - Method of Test and SAEJ765 Crane Stability Test Code.

2. Rated loads include the weight of hookblock, slings and auxiliary lifting devices and their weights shall be subtracted from the listed rating to obtain the net load to be lifted. When more than the minimum required hoist reeving is used, the additional rope weight shall be considered part of the load to be handled.

3. Defined Arc  $\pm 6^\circ$  on either side of longitudinal centerline of machine.

4. Capacities appearing above the bold line are based on structural strength and tipping should not be relied upon as a capacity limitation.





































5. The machine shall be leveled on a firm supporting surface. Depending on the nature of the supporting surface, it may be necessary to have structural supports under the outrigger floats or tires to spread the load to a larger bearing surface.

6. When either boom length or radius or both are between values listed, the smallest load shown at either the next larger radius or next longer or shorter boom length shall be used.

7. Tires shall be inflated to the recommended pressure before lifting on rubber.

8. For outrigger operation, outriggers shall be properly extended with tires raised free of crane weight before operating the boom or lifting loads.

# Symbols Glossary

	Frame		Steering
	Outriggers		Transmission
	Outrigger Controls		Axles
	Engine		Brakes
	Fuel Tank Capacity		Tires
	Electrical System		Suspension
	Drive		Rotation
	Lights		Boom Elevation
	Cab		Swing
	Boom		Counterweight
	Fixed Swingaway		Oil
	Tele-Swingaway		Hydraulic System
	Jib		Hoist
	Boom Nose		Radius
	Boom Extension		Boom Length
	Speed		Hookblock
	Grade		Gear
	Lattice Extension		Luffing Jib

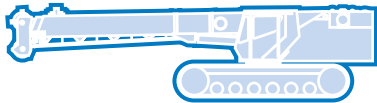
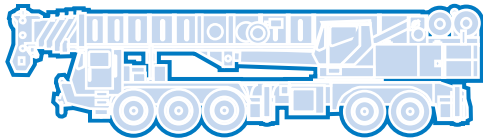
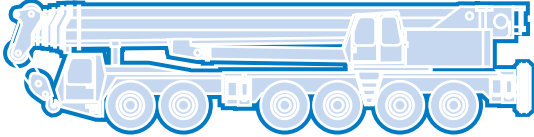
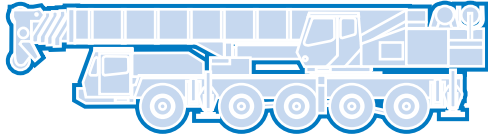

**Grove Worldwide – World Headquarters**

**Grove North America**  
1565 Buchanan Trail East  
P.O. Box 21  
Shady Grove, Pennsylvania 17256, U.S.A.  
Tel: [Int + 1] (717) 597-8121  
Fax: [Int + 1] (717) 597-4062  
Western Hemisphere, Asia/Pacific

**Grove Europe Limited\***  
Sunderland SR4 6TT, England  
Tel: [Int + 44] 191 565-6281  
Fax: [Int + 44] 191 564-0442  
Europe, Africa, Middle East

**Grove Europe Limited\***  
P.O. Box No. 268  
4A Kimber Road  
Abingdon, Oxfordshire, OX141SG  
Tel: [Int + 44] 1235 55-3184  
Fax: [Int + 44] 1235 55-3218  
\*Grove Europe Limited, Registered in England,  
Number 1845128, Registered office, Crown Works,  
Pallion, Sunderland, Tyne & Wear, England SR4 6TT

**Deutsche Grove GmbH**  
**Sales and Service**  
Helmholtzstrasse 12, Postfach 5026  
D-40750 Langenfeld, Germany  
Tel: [Int + 49] (2173) 8909-0  
Fax: [Int + 49] (2173) 8909-30

**Wilhelmshaven Works**  
Industriegelände West, Postfach 1853  
D-26358 Wilhelmshaven, Germany  
Tel: [Int + 49] (4421) 294-0  
Fax: [Int + 49] (4421) 294-301

**Grove France S.A.**  
16, chaussée Jules-César, 95520 OSNY  
B.P. 203, 95523 CERGY PONTOISE CEDEX  
France  
Tel: [Int + 33] (1) 30313150  
Int: [Int + 33] (1) 30386085

**Grove Asia/Pacific - Regional Office**  
171 Chin Swee Road  
#06-01 San Centre  
Singapore 0316  
Tel: [Int + 65] 536-6112  
Fax: [Int + 65] 536-6119  
Asia/Pacific, Near East

**Grove China - Representative Office**  
Beijing Suite 6074  
No. 33 East Chang An Avenue  
Beijing, 100004, China  
Tel: [Int + 86] (10) 513-7766  
Fax: [Int + 86] (10) 513-7307

**Grove Product Support**  
Western Hemisphere, Asia/Pacific  
1086 Wayne Avenue  
Chambersburg, Pennsylvania USA  
Tel: [Int + 1] (717) 263-5100  
Fax: [Int + 1] (717) 267-0404

Europe, Africa, Middle East  
Sunderland SR4 6TT, England  
Tel: [Int + 44] 191 565-6281  
Parts Fax: [Int + 44] 191 510-9242  
Service Fax: [Int + 44] 191 510-9560

<http://www.grovetworldwide.com>

Constant improvement and engineering progress make it necessary that we reserve the right to make specification, equipment, and price changes without notice. Illustrations shown may include optional equipment and accessories and may not include all standard equipment.

Distributed By: