

National Series 400A Proposal

Date: _____
 Prepared for: _____
 Submitted by: _____
 (Firm Name) _____
 (Address) _____
 (City & State) _____
 (Zip) _____
 (Phone) _____
 Signed: _____

National reserves the right to change designs, prices, and specifications at any time without notice.

Your National Dealer

Description	Price
1. Series _____	\$ _____
2. Deduct: if torsion box not required _____	(_____)
3. Boom _____	_____
4. Jib _____	_____
5. Rear Stabilizers <input type="checkbox"/> ASH <input type="checkbox"/> RSH 18"	_____
6. Front Stabilizers <input type="checkbox"/> Std. <input type="checkbox"/> Tilt <input type="checkbox"/> Single	_____
7. Line Block <input type="checkbox"/> 2 Part <input type="checkbox"/> 2 & 3 Part <input type="checkbox"/> 4 Part	_____
Accessories	
8. PD-12 Planetary Winch _____	_____
9. _____	_____
10. _____	_____
11. _____	_____
Mounting	
12. Installation: Behind Cab _____	_____
13. Installation: Rear Mounting (add to installation charge above)	
<input type="checkbox"/> ASH Behind Cab Stabilizers _____	_____
<input type="checkbox"/> Air Throttle _____	_____
<input type="checkbox"/> Rear Mounting Group _____	_____
<input type="checkbox"/> HO Outriggers _____	_____
14. Frame Reinforcement: <input type="checkbox"/> Weld <input type="checkbox"/> Bolt-Extra _____	_____
15. Platform Body _____ ft. <input type="checkbox"/> Wood <input type="checkbox"/> Steel _____	_____
16. Weight in bed _____ lbs. (if required) _____	_____
17. Boom rest: <input type="checkbox"/> Parallel <input type="checkbox"/> Low <input type="checkbox"/> Other _____	_____
18. Mount Stabilizers (Rear) _____	_____
19. Mount Stabilizers (Front) _____	_____
20. Chassis _____	_____
21. Rear Bumper Underride Protection <input type="checkbox"/> Ordered <input type="checkbox"/> Not Ordered _____	_____
22. Freight _____	_____
This quotation will remain firm for _____ days.	
Accepted by: _____ (Name)	\$ _____ TOTAL PRICE
_____ (Firm Name)	_____ (Date)

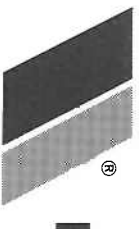

NATIONAL CRANE

General Offices: 11200 North 148th Street/Waverly, NE 68462
 Phone: 402/786-2240; Telex: 438061; Fax: 402/786-3636

National Series 400A

Truck-Mounted Telescoping Cranes and Accessories

Maximum Vertical Reach: 95 Feet (28.9 Meters)
 Maximum Capacity: 20,000 Pounds (9.1 Metric Tons)

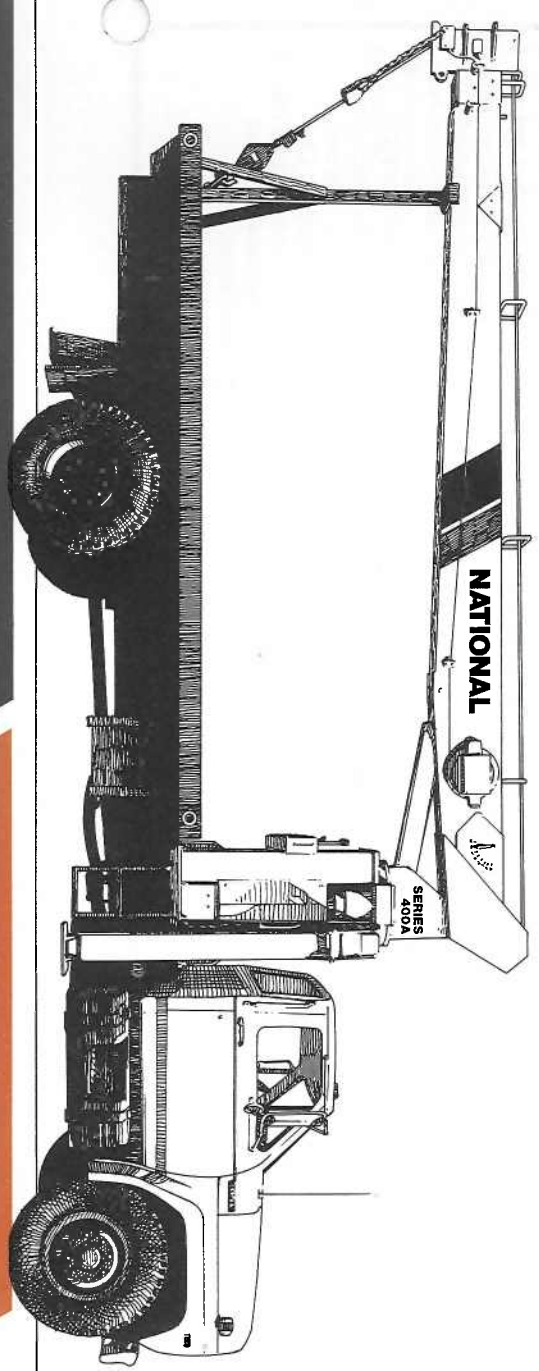

A NEW medium-duty telescoping crane from National, America's truck-mounted hydraulic crane leader!

Preliminary Specifications

Why buy a National Series 400A?

ALL NEW!



To provide our customers with products where Quality and Reliability are integral with design and manufacturing.

National Crane, America's truck-mounted hydraulic crane leader, features the industry's premier lineup of hard working telescoping and articulating cranes. The medium duty Series 400A telescoping crane with its 10-ton (9.1MT) capacity and 95-foot (28.9m) vertical reach offers many advantages:

- **National's field-proven durability**
- National has manufactured cranes since 1963.
- Nearly 17,000 field-proven cranes verify National's manufacturing expertise.

Attention to quality

- National's industry-leading testing program subjects all prototype models to state-of-the-art strain gauge and life cycle testing to verify structural integrity.
- Each 400A undergoes numerous quality inspections at all levels of manufacture and assembly.

Retained market value

- National cranes traditionally retain higher resale value year after year.

Responsive service

- Each 400A is backed by strong after-sale and service support. Our professional, factory-trained dealer network spans the nation.

- Authorized National dealers maintain a parts stocking program for your 400A.

- When a dealer cannot immediately supply a part, the factory's backup program provides 24-hour parts shipping in 90% of all breakdown rush orders.

Strong warranty protection

- The 400A is backed by a solid warranty covering defects in materials and workmanship for six months from the date of shipment. And more...

Our Series 400A telescoping crane gives you everything you want and need in a tough, compact, medium-duty crane. Here are all-new features that make the 400A the top crane in its class:

- 10-ton (9.1MT) rated capacity (two full tons more than the 400A predecessor model) makes this unit the **highest capacity crane in its class in the industry**
- Higher reach — up to 95 feet (28.9m) (with Model 456A with a 29-foot manual pull-out jib)
- Stronger booms that lift more
- Proportional boom design provides smoother, more efficient boom operation, higher capacities (particularly in normal lifting

areas), more efficient weight distribution, and utilizes a single extend cylinder (eliminating 18 potential leak points and minimizing hydraulic maintenance)

- Increased payload capacity (up to 7,000 pounds can be hauled on a standard truck)
- Accomplished through a wider outrigger span and increased gross rear axle weight rating
- New, extra-wide outrigger span provides solid stability without adding extra counterweight
- New state-of-the-art O-ring seal fittings on all high pressure lines reduce downtime by eliminating fitting leakage

New boom pivot and lift cylinder bearings provide longer life and lower maintenance

- A new standard tandem pump system isolates the winch from other crane functions to provide better overall performance

Here are other typical features that National 400A crane users will appreciate:

- Extra large wear pads in the boom last longer and are easier to replace
- Dual controls in SAE recommended orientation of functions (you always work the same control with the same hand)
- Each operating station is equipped with a foot throttle and a precision machine level
- Standard high-performance planetary winch with rotation-resistant cable
- Standard anti-two-block feature to prevent cable damage when winching up or extending the boom without paying-out the winch cable
- Planetary rotation gear box with a hydraulic release brake and a slip-through feature that helps protect the rotation system against damage from accidental side loading
- Outrigger location (behind the operator) allows occasional 360-degree working area without front stabilizers when the crane is mounted on a recommended truck
- Larger outrigger pads provide greater stability in soft footing
- Mounts on standard, single-rear-axle trucks with the versatility of five mounting configurations
- Horn and stop switches are located at both control stations
- Complete accessory line adds to the versatility of the 400A

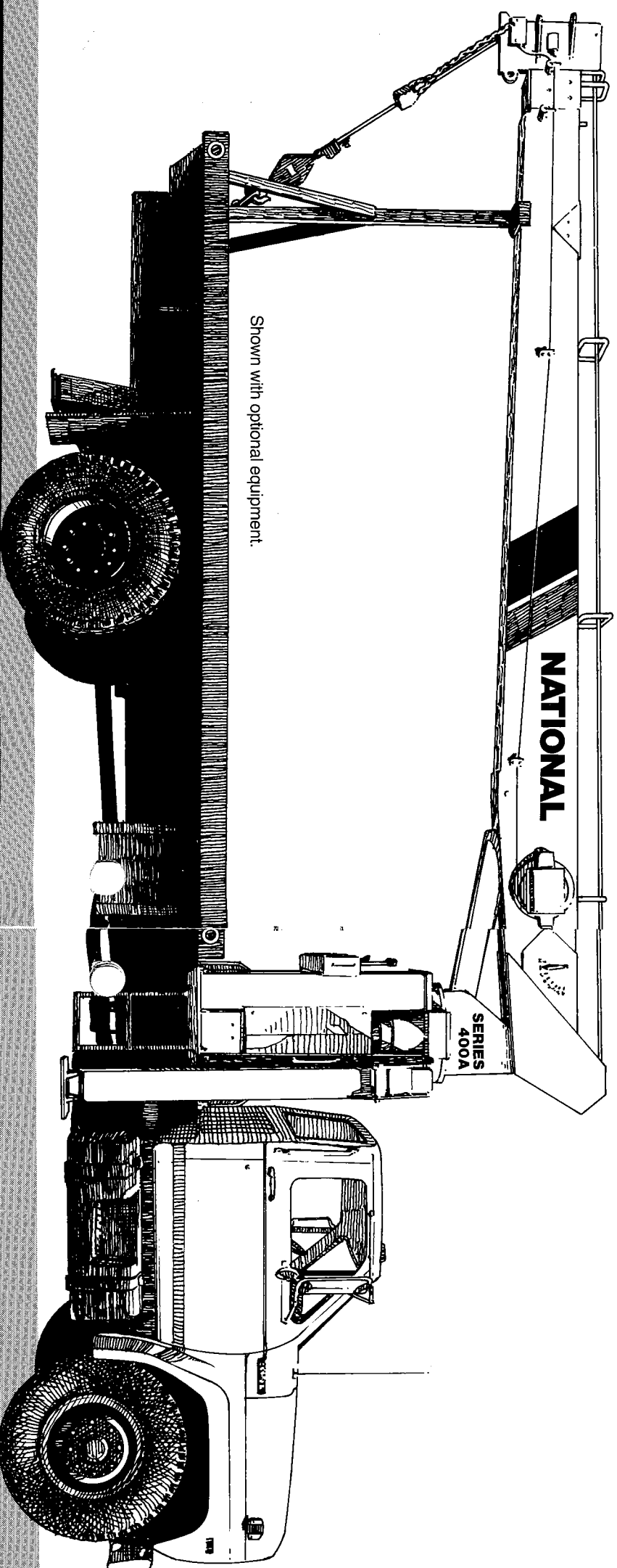

Shown with optional equipment.

National Series 400A

Strong Four-Plate Booms

Through computer aided design, National has improved weight efficiency of the Series 400A boom sections. We fabricate our telescoping boom sections from four high-strength steel members welded with perpendicular corners. This box-section construction lets us use thicker top and bottom plates for extra strength. The use of thinner side plates means increased capacity through lower boom weight. Only strong, low alloy steel is used in National booms. It is welded with automatic, low-hydrogen techniques for extra strong seams. Corner seams are ultrasonically tested for proper penetration.

The National Series 400A is equipped on all sides with large nylon wear pads impregnated with lubricants, providing a smooth, long-life operation. The wear resistance of the material used in the Series 400A pads is unexcelled by competitive models.

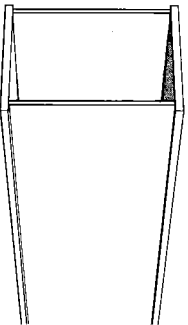

Proportional Boom Extension

Proportional (cable crowd) boom design (each boom section extends and retracts proportionally during the telescoping operation) provides more efficient boom weight distribution. This means smoother, more efficient boom operation and higher capacities for you. Since the system utilizes only one extend cylinder, hydraulic maintenance is minimized. Boom telescope cylinder is fully protected with a direct mount holding valve.

Anti-Two-Block

The 400A is equipped with a standard anti-two-block attachment. Two blocking occurs when the winch cable and attachments contact the underside of the boom sheave case, whether by winching up or extending the boom without paying out the winch cable. When this happens, the cable can be damaged by crimping or over-tensioning. The anti-two-block attachment prevents cable damage by sensing the position of the winch cable end attachments with respect to the sheave case and shutting down the functions that can cause two blocking.

Easy Service, Low Downtime

The Series 400A frame allows easy access to control valves and plumbing for minor adjustments and fitting tightening. The complete console is easily removable for major repair.

Dual Controls

Dual controls are standard on the Series 400A. The extra fine metering and low spool forces give you smoother, more precise control. Crane controls are identical on each side with SAE recommended orientation of functions. That means you always work the same control with the same hand. Dual stations provide more efficient operations and greater load visibility. Each station is equipped with kill and audible warning switches. A system pressure gauge is standard for easily checking pressures on all control functions. Foot throttles allow identical foot operation of engine speed from either side. Control rods are supported by nylon bearings, promoting smooth operation and reducing lubrication requirements.

High Performance Planetary Winch

The 400A comes standard with a high-performance planetary gear drive winch. Anti-friction bearings are used throughout to maximize efficiency and seal life. A winch drum rotation indicator has been added.

This high-capacity winch has increased efficiency and, therefore, requires less horsepower and generates less heat. For fine control, both brake and counter-balance valves are standard. New winch covers improve visibility of drum and cable. The winch is filled with $\frac{1}{2}$ " diameter rotation resistant cable. See the winch data chart on page seven for further information.

Positive Planetary Turret Rotation

The planetary rotation gearbox with a hydraulic release brake allows the gearbox to backdrive whenever excessive side load is applied to the boom, reducing shock loads on the upper and lower crane structure and gearbox. The turret drive is designed with extra heavy bearings below the drive pinion. The gearbox and rotation bearing mounting surfaces are precision machined after welding. This ensures constant tooth alignment for smooth rotation and low wear, even under

maximum loads. The entire turret glides smoothly on a low inertia ball bearing race. Rotation is 375° noncontinuous. The 400A is equipped with a turret rotation indicator to aid the operator in positioning loads.

This high-capacity winch has increased efficiency and, therefore, requires less horsepower and generates less heat. For fine control, both brake and counter-balance valves are standard. New winch covers improve visibility of drum and cable. The winch is filled with $\frac{1}{2}$ " diameter rotation resistant cable. See the winch data chart on page seven for further information.

Less Space

The National Series 400A is built tough, but compact, so it fits in just 36.75 inches (933mm) of bed space. That leaves ample payload space, making your Series 400A even more versatile. The 400A controls and operator platforms are designed with an improved access to the truck bed, permitting the operator to move from one control station to the other. The operator platforms are made with open mesh expanded metal to keep dirt and mud buildup to a minimum.

Less Weight

The Series 400A is designed with wider outriggers and a new rigid subframe to reduce the need for counterweight on virtually every truck on which it can be mounted. Even with its increased capacity, it weighs less than its predecessor model when mounted on the same minimum truck.

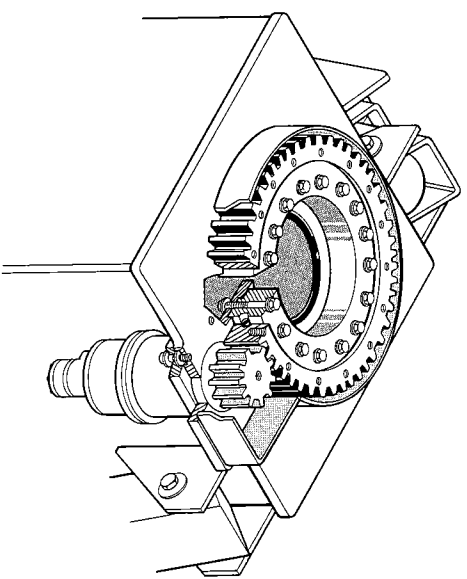

Wide Stance

We've given our Series 400A the industry-acclaimed National out-and-down outriggers for a consistently wide stance and better leveling on uneven ground. The outriggers retract smoothly, without binding under load, first moving up, then in. Their efficient design

and wider span — 16.4-feet (5,000mm) — gives you greater stability with less truck weight, so you can carry larger payloads. The 400A is equipped with larger pads for greater stability in soft footing. A precision mounted level indicator aids the operator in leveling the unit during the set-up procedure.

National's "Out-and-Down" Stable Outriggers CRANE

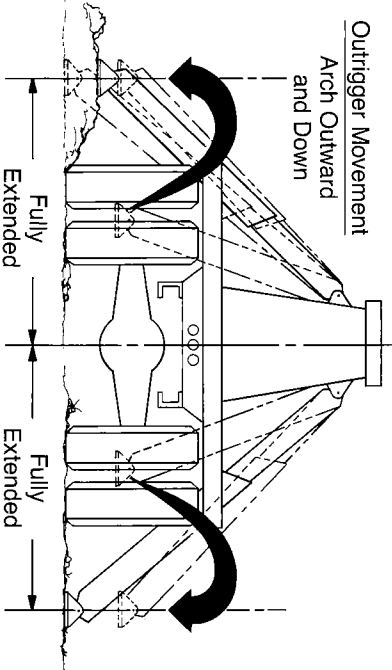

- Outriggers equally spaced from crane center line.
- Consistent outrigger span.
- Crane will be equally stable on both sides.

The National Testing Program

National Crane established its original product durability standards by carefully evaluating the performance of competitive machines. Taking the best performances from these tests, National engineers set their own standards **more than 50% higher!** This is the same testing standard each National must pass today. Before a new model is released for production manufacturing it is subjected to state-of-the-art testing. For example, a plastic-based "brittle lacquer" coating is

applied to the crane. After loading, test engineers inspect the coating for cracks. The special lacquer has virtually no elastic qualities, so stretching or deformation of the metal shows up in "fractures" of the coating, perpendicular to the direction of stretching. This procedure indicates where engineers are to place strain gauges, tiny chips printed with electronic circuitry which expand or contract with changes in the metal. Minute changes in electrical resistance are

The National Parts System

Authorized National Crane dealers maintain a parts supply to support the National cranes in each dealer's area. If a dealer cannot immediately supply a needed part, the factory maintains a back-up parts supply that provides 24-hour parts shipping in 90% of all breakdown rush orders. National's responsiveness to dealer requests means that your crane will be back on the job fast. National maintains a highly trained Service and Parts staff to answer dealer service questions and expedite parts shipping.

The National Warranty

National's warranty covers your crane against defects in materials or workmanship for **six full months** from the date of shipment, subject to the conditions of the warranty. When you select a National crane, you're getting more than just a crane. You're getting a nationwide dealer warranty service network, strong warranty protection and our special concern for every product we make. Read our warranty. Then, don't settle for less. For

complete information, write National Warranty Service, Waverly, NE 68462.

The National Service Center

National maintains a well-equipped service center where we do all our factory crane mounting. The central location of our Service Center makes it easy to return cranes for special modifications or extreme repairs. Most National dealers can perform all but the most unusual modifications or most serious repairs.

Should you need to return your crane to us for modification, warranty repair or other service, we will give it priority care and see it's returned as soon as possible.

Do not operate crane or accessories within 10 feet (3m) of live power lines.

to a multi-level inspection program during manufacture and assembly. National's attention to testing ensures that each crane delivered to the field is ready for on-the-job action.

National Series 400A Booms and Jibs

Heights to 95 feet (28.9m) available
The National Series 400A is available with a choice of booms and jibs. One of these combinations is right for your 10-ton capacity lifting

requirements. Select the telescoping boom you want, then add one of National's jib options as a cost-efficient way to increase the capacity and versatility of your Series 400A.

Do not operate cranes or accessories within 10 feet (3m) of live power lines.

1. Load ratings shown on these charts are maximum allowable loads with the outriggers properly extended on a firm, level surface and the crane leveled and recommended truck.
2. Always level the crane with the level indicator located on the crane frame.
3. The operator must reduce loads to allow for factors such as wind, ground conditions, operating speeds and the effect of freely suspended loads.
4. Overloading the crane may cause structural collapse or instability.
5. Weights of any accessories attached to the boom or loadline must be deducted from the load chart capacities.
6. Do not exceed jib capacities at any reduced boom lengths.

Boom and Jib Combinations

- Telescoping Booms**
- Model 428A: 12½ ft.-28-foot (3.8m to 8.5m) three section
 - Model 437A: 15½ ft.-to 37-foot (4.7m to 11.3m) three section
 - Model 446A: 18½ ft.-to 46-foot (5.6m to 14m) three section
 - Model 456A: 22- to 56-foot (6.7m to 17.1m) three section
- Jib Options (side stowing)**
- Model 4FJ12: 12-foot (3.7m) straight (for Model 428A)
 - Model 4FJ15: 15-foot (4.6m) straight (for Model 437A)
 - Model 4FJ18: 18-foot (5.5m) straight (for Models 446A, 456A)
 - Model 4FJ29M: 18- to 29-foot (5.5m to 8.8m) manual pull-out (for Models 446A, 456A)

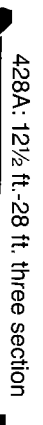

456A Capacity* (without jib)
(Metric equivalents shown in parentheses)

Radius	Boom Fully Retracted 22' (6.7m)	Boom 32' Extended (9.8m)	Boom 40' Extended (12.2m)	Boom 48' Extended (14.6m)	Boom Fully Extended 56' (17.1m)
5' (1.5m)	20000 lbs. (9072 kg)				
6' (1.8m)	17000 lbs. (7711 kg)	10400 (4717)	9700 (4400)		
8' (2.4m)	12500 lbs. (5670 kg)	8800 (3992)	8450 (3833)		
10' (3.0m)	9650 lbs. (4377 kg)	7600 (3447)	7000 (3175)	6600 (2994)	
12' (3.7m)	8300 lbs. (3765 kg)	6550 (2971)	6100 (2767)	5800 (2631)	5600 (2540)
14' (4.3m)	7350 lbs. (3334 kg)	5850 (2654)	5500 (2495)	5200 (2359)	4900 (2223)
16' (4.9m)	6450 lbs. (2926 kg)	5360 (2427)	5000 (2268)	4600 (2087)	4350 (1973)
18' (5.5m)	5800 lbs. (2631 kg)	4850 (2200)	4550 (2064)	4300 (1950)	3900 (1769)
20' (6.1m)	5050 lbs. (2291 kg)	3850 (1746)	3600 (1633)	3400 (1542)	3150 (1429)
25' (7.6m)		3000 (1361)	3000 (1361)	2850 (1293)	2550 (1157)
30' (9.1m)			2400 (1089)	2400 (1089)	2200 (998)
35' (10.7m)			1500 (680)	2050 (930)	1900 (862)
40' (12.2m)				1700 (771)	1600 (726)
45' (13.7m)					1400 (635)
50' (15.2m)					1050 (476)
55' (16.8m)					

*Capacities shown are for the 456A with the load suspended, radius shown is for loaded boom. Capacities vary for cranes equipped with jibs or attachments. The capacities shown will be reduced when accessories are attached to the boom or loadline. Consult factory for specific load rating information.

Note: Rated loads do not exceed 85% of the tipping load. The structural strength ratings in the chart above are shaded.

NATIONAL SERIES 400A WINCH DATA

- Caution:**
- Do not deadhead lineblock against boom tip when extending boom.
 - Keep at least three wraps of load line on drum at all times.
 - Use only the specified cable on this machine.

Winch	Cable Supplied	Average Breaking Strength	Lift and Speed	Lift and Speed	Lift and Speed	Lift and Speed
Standard Planetary Winch	Standard ½" diam. rotation resistant	29,200 lbs. (13,250 kg)	5,840 lbs. (2,650 kg) 184 fpm (56 m/min)	11,680 lbs. (5,300 kg) 92 fpm (28 m/min)	17,520 lbs. (7,950 kg) 61 fpm (19 m/min)	20,000 lbs. (9,075 kg) 46 fpm (14 m/min)
	Optional ½" diam. 6 x 19 or 6 x 25 IWRC	23,000 lbs. (10,436 kg)	5,840 lbs. (2,650 kg) 184 fpm (56 m/min)	11,680 lbs. (5,300 kg) 92 fpm (28 m/min)	17,520 lbs. (7,950 kg) 61 fpm (19 m/min)	20,000 lbs. (9,075 kg) 46 fpm (14 m/min)
Optional High-pull Planetary Winch	Standard ¾" diam. rotation resistant	37,000 lbs. (16,788 kg)	7,400 lbs. (3,357 kg) 110 fpm (34 m/min)	14,800 lbs. (6,715 kg) 55 fpm (17 m/min)	20,000 lbs. (9,075 kg) 37 fpm (11 m/min)	—
	Optional ¾" diam. 6 x 19 or 6 x 25 IWRC	29,750 lbs. (13,500 kg)	8,400 lbs. (3,811 kg) 110 fpm (34 m/min)	16,800 lbs. (7,622 kg) 55 fpm (17 m/min)	20,000 lbs. (9,075 kg) 37 fpm (11 m/min)	—

All winch pulls and speeds are shown on the third layer. Winch pulls would increase on the first and second layers. Winch line speeds would decrease on the first and second layers. Winch pulls may be limited by the winch capacity or the OSHA 5 to 1 or 3.5 to 1 safety factor. These are shown below.

Winch	Winch Limited	Standard	Optional
Standard Planetary	6,835 lbs. (3,101 kg)	5,840 lbs. (2,650 kg)	5,840 lbs. (2,650 kg)
Optional Planetary	10,200 lbs. (4,628 kg)	7,400 lbs. (3,357 kg)	8,400 lbs. (3,811 kg)

National Series 400A Load Rating Charts

Note: Rated loads do not exceed 85% of the tipping load. Structural strength ratings in the charts below and on the following page are shaded.

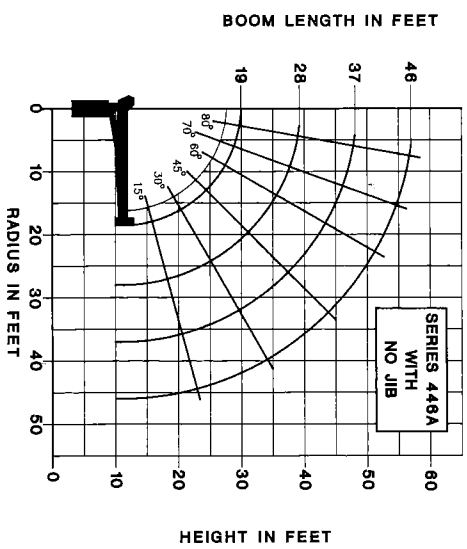

LOAD RADIUS (FEET)	LOADED BOOM ANGLE	LOAD RATINGS						
		19FT BOOM (LBS)	28FT BOOM (LBS)	37FT BOOM (LBS)	48FT BOOM (LBS)	48FT BOOM (LBS)		
4	79°	20,000	79°	13,000				
6	73°	15,000	75°	10,200	80°	10,000		
8	66°	12,000	71°	9,350	76°	9,450		
10	59°	10,000	66°	7,800	73°	7,400	77°	6,550
12	52°	7,800	62°	6,000	69°	6,200	72°	5,200
14	43°	7,800	57°	5,000	66°	5,500	72°	5,200
16	32°	6,950	53°	5,000	63°	5,150	69°	4,550
18	18°	5,850	47°	5,050	60°	4,650	67°	4,350
20			30°	4,100	50°	3,800	60°	3,500
25					39°	3,150	53°	3,000
30					22°	2,800	45°	2,500
35							32°	2,500
40							15°	1,800
45								

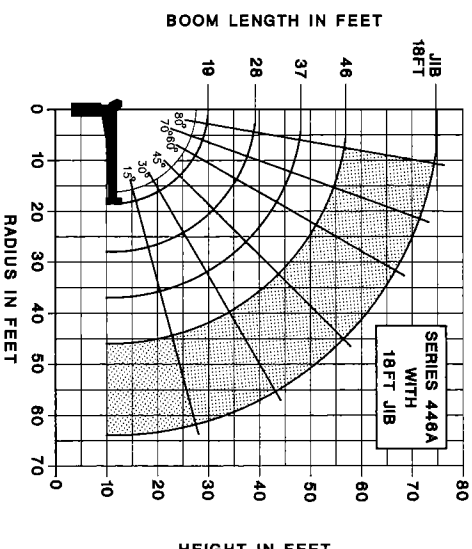

LOAD RADIUS (FEET)	LOADED BOOM ANGLE	LOAD RATINGS						
		19FT BOOM (LBS)	28FT BOOM (LBS)	37FT BOOM (LBS)	48FT BOOM (LBS)	48FT BOOM (LBS)		
4	79°	20,000	79°	12,800				
6	73°	15,000	75°	10,500	80°	9,850		
8	66°	11,750	71°	9,150	76°	8,300		
10	59°	9,750	66°	7,300	73°	7,250	77°	6,750
12	52°	8,850	62°	6,000	69°	6,050	72°	5,650
14	43°	7,550	57°	5,800	66°	5,350	72°	5,100
16	32°	6,700	53°	5,300	63°	5,000	69°	4,550
18	18°	5,600	47°	4,850	60°	4,500	67°	4,250
20			30°	3,800	50°	3,500	60°	3,400
25					39°	3,000	53°	2,900
30					22°	2,450	45°	2,350
35							32°	2,150
40							15°	1,700
45								

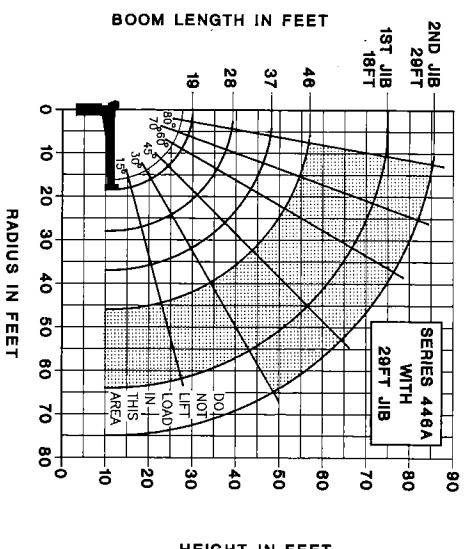

LOAD RADIUS (FEET)	LOADED BOOM ANGLE	LOAD RATINGS						
		19FT BOOM (LBS)	28FT BOOM (LBS)	37FT BOOM (LBS)	48FT BOOM (LBS)	48FT BOOM (LBS)		
4	79°	20,000	79°	12,750				
6	73°	15,000	75°	10,450	80°	9,800		
8	66°	11,800	71°	9,100	76°	8,250		
10	59°	9,800	66°	7,350	73°	7,200	77°	6,700
12	52°	8,700	62°	6,000	69°	6,000	72°	5,650
14	43°	7,400	57°	5,750	66°	5,300	72°	5,050
16	32°	6,450	53°	5,250	63°	4,950	69°	4,500
18	18°	5,450	47°	4,800	60°	4,450	67°	4,200
20			30°	3,850	50°	3,500	60°	3,400
25					39°	2,850	53°	2,850
30					22°	2,400	45°	2,450
35							32°	2,180
40							15°	1,650
45								

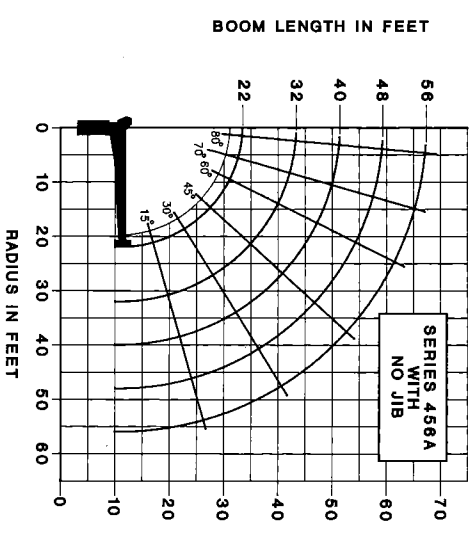

LOAD RADIUS (FEET)	LOADED BOOM ANGLE	LOAD RATINGS						
		22FT BOOM (LBS)	32FT BOOM (LBS)	40FT BOOM (LBS)	48FT BOOM (LBS)	48FT BOOM (LBS)		
5	79°	20,000						
6	76°	17,000	77°	10,400	80°	9,700		
8	70°	12,500	73°	8,800	77°	8,450		
10	65°	9,650	69°	7,600	74°	7,000	77°	6,600
12	59°	8,300	66°	6,550	71°	6,100	75°	5,800
14	52°	7,350	63°	5,850	68°	5,300	73°	5,000
16	44°	6,450	59°	5,250	65°	4,850	70°	4,500
18	37°	5,800	54°	4,850	62°	4,550	68°	4,300
20	26°	5,050	41°	3,950	54°	3,600	61°	3,150
25			22°	3,000	44°	3,000	54°	2,650
30					31°	2,400	45°	2,400
35					2°	1,500	35°	2,050
40							22°	1,700
45							13°	1,400
50								
55								

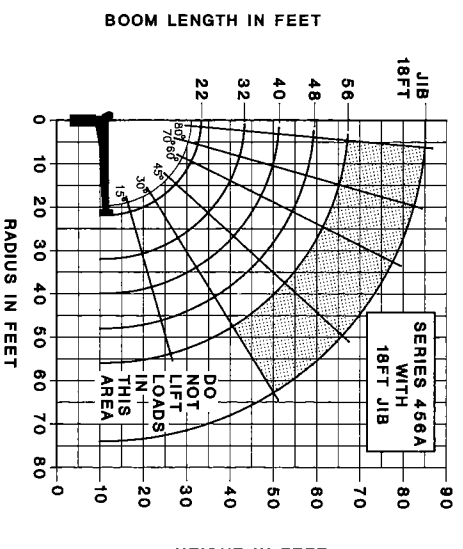

LOAD RADIUS (FEET)	LOADED BOOM ANGLE	LOAD RATINGS						
		22FT BOOM (LBS)	32FT BOOM (LBS)	40FT BOOM (LBS)	48FT BOOM (LBS)	48FT BOOM (LBS)		
5	79°	20,000						
6	76°	17,000	77°	10,300	80°	9,550		
8	70°	12,400	73°	8,650	77°	8,300		
10	65°	9,450	69°	7,550	74°	6,850	77°	6,500
12	59°	8,100	66°	6,400	71°	5,950	75°	5,700
14	52°	7,150	63°	5,700	68°	5,350	73°	5,100
16	44°	6,250	59°	5,200	65°	4,850	70°	4,500
18	37°	5,600	54°	4,700	62°	4,400	68°	4,200
20	26°	4,850	41°	3,700	54°	3,400	61°	3,050
25			22°	2,850	44°	2,850	54°	2,450
30					31°	2,300	45°	2,300
35					2°	1,400	35°	1,900
40							22°	1,600
45							13°	1,300
50								
55								

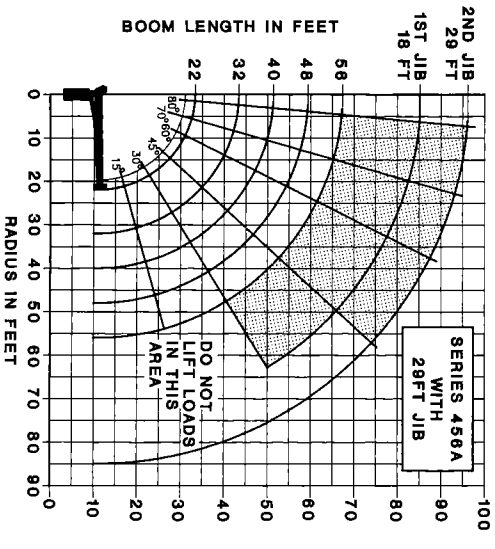

LOAD RADIUS (FEET)	LOADED BOOM ANGLE	LOAD RATINGS						
		22FT BOOM (LBS)	32FT BOOM (LBS)	40FT BOOM (LBS)	48FT BOOM (LBS)	48FT BOOM (LBS)		
5	79°	20,000						
6	76°	17,000	77°	10,200	80°	9,450		
8	70°	12,200	73°	8,500	77°	8,200		
10	65°	9,250	69°	7,300	74°	6,750	77°	6,400
12	59°	8,850	66°	6,250	71°	5,850	75°	5,600
14	52°	8,850	62°	5,250	69°	5,250	73°	5,000
16	44°	8,850	58°	5,250	66°	5,000	70°	4,750
18	37°	7,400	54°	4,300	62°	4,300	68°	4,200
20	26°	6,500	41°	3,200	54°	3,200	61°	3,750
25			22°	2,750	44°	2,750	54°	3,000
30					31°	2,250	54°	2,400
35					2°	1,300	35°	2,050
40							22°	1,750
45							13°	1,500
50								
55								

National Series 400A Truck Specifications

Mounting Configurations	Configuration 1 with Subbase		Configuration 2 with Subbase and SFO		Configuration 3 with Subbase and Counterweight		Configuration 4 without Subbase		Configuration 5 with H-D Subbase	
	This configuration allows the installation of the Series 400A on a chassis with a small frame by using the standard subbase. In most cases, the chassis will not require reinforcing and counterweight will not be required. With this configuration, a payload of approximately 7,000 pounds can be hauled on a minimum truck. Requires standard subbase and rear stabilizers. Full capacity work area in rear 180° of vehicle from outrigger to outrigger.		This configuration requires a front stabilizer for full capacity 360° around the truck. A front stabilizer gives the machine a solid base, helping the operator control crane loads. Requires front and rear stabilizers and standard subbase. A front stabilizer for this configuration requires the following section modulus from the back of the front spring hangers through the front suspension and to the front stabilizer: ● 50,000 PSI — 13.5 inch ³ ● 110,000 PSI — 6.2 inch ³ Normally a tapered front frame cannot be reinforced to these minimums.		This mounting configuration allows 360° stability at full capacity without the use of a front stabilizer. It requires additional weight at the rear of the truck to reduce loading on the front axle when lifting over the front. Since the front tires are used as a stabilizing base, this mount is recommended only for the operator who occasionally lifts loads over the front of the vehicle. If loads are to be continually lifted around the front of the vehicle, a front stabilizer is required to give the mount a firm base. Requires rear stabilizers and standard subbase with counterweight in subbase or underside of bed.		The Series 400A can be mounted without the factory-furnished subbase provided the truck is above minimum specifications for truck frame strength and chassis weight. A 400A mounted in this manner will be 180° stable over the rear of the vehicle from outrigger to outrigger.		The advantages of a rear-mounted Series 400A are: (1) it allows the operator to effectively use the close-in working area to lift heavier loads, and (2) 360° solid stability at full rated load. Counterweight up to 3000 pounds will be required on a minimum truck. With this configuration, a payload of approximately 5,500 pounds can be hauled on a minimum truck. Underframe stabilizers behind the cab may interfere with the drive line or cause ground clearance problems. If so, contact the factory for alternatives.	
Stable	180°	360°	360°	180°	360°					
Gross Axle Weight Rating (GAWR), Front	9,000 lbs.	9,000 lbs.	9,000 lbs.	9,000 lbs.	9,000 lbs.				9,000 lbs.	
Gross Axle Weight Rating (GAWR), Rear	19,000 lbs.	19,000 lbs.	19,000 lbs.	19,000 lbs.	19,000 lbs.				19,000 lbs.	
Wheelbase (WB)	184 inches on Model 437A, 207 inches on Models 446A, 456A	184 inches on Model 437A, 207 inches on Models 446A, 456A	184 inches on Model 437A, 207 inches on Models 446A, 456A	184 inches on Model 437A, 207 inches on Models 446A, 456A	207 inches				207 inches	
Cab to axle/trunnion (CA/CT)	120 inches on Model 437A, 138 inches on Models 446A, 456A	120 inches on Model 437A, 138 inches on Models 446A, 456A	120 inches on Model 437A, 138 inches on Models 446A, 456A	120 inches on Model 437A, 138 inches on Models 446A, 456A	139 inches				139 inches	
Frame Section Modulus (SM) under crane	13 inch ³	13 inch ³	13 inch ³	32 inch ³	13 inch ³				13 inch ³	
or	10 inch ³	10 inch ³	10 inch ³	15 inch ³	10 inch ³				10 inch ³	
110,000 PSI	10 inch ³	10 inch ³	10 inch ³	18 inch ³	13 inch ³				13 inch ³	
Frame Section Modulus (SM) over rear stabilizers	10 inch ³	10 inch ³	10 inch ³	10 inch ³	10 inch ³				10 inch ³	
50,000 PSI	4,800 lbs. minimum 5,600 lbs. maximum	4,800 lbs. minimum 5,200 lbs. maximum	4,800 lbs. minimum 5,600 lbs. maximum	5,400 lbs. minimum 5,600 lbs. maximum	5,900 lbs.				5,900 lbs.	
110,000 PSI	4,600 lbs.	4,600 lbs.	6,100 lbs.	5,000 lbs.	6,800 lbs.				6,800 lbs.	
Stability Weight, Front†	4,800 lbs. minimum 5,600 lbs. maximum	4,800 lbs. minimum 5,200 lbs. maximum	4,800 lbs. minimum 5,600 lbs. maximum	5,400 lbs. minimum 5,600 lbs. maximum	5,900 lbs.				5,900 lbs.	
Stability Weight, Rear†	4,600 lbs.	4,600 lbs.	6,100 lbs.	5,000 lbs.	6,800 lbs.				6,800 lbs.	
Estimated Average Final Weight (No Options included)	19,500 lbs.	19,800 lbs.	21,000 lbs.	20,000 lbs.	22,500 lbs.				22,500 lbs.	
NOTES: (1) GAWR means gross axle weight rating and is dependent on all components of the vehicle such as axles, tires, springs, frame, etc. meeting manufacturer's recommendations. Always specify GAWR when purchasing trucks. (2) Minimum axle requirements may increase with use of longer wheelbase, service bodies, diesel engines or front stabilizers. (3) Tandem axle trucks must be used for hauling larger payloads. (4) Diesel engines require variable speed governor and energize-to-run fuel solenoid for smooth crane operation. (5) On trucks shorter than 120 CA, additional weight may be required at the rear axle for 360° stability. (6) On trucks with front axle weight of 5,200 lbs. or greater, a 9,000 lb. GAWR (Front) will not be adequate if front-mounted stabilizers are used for continuous lifting over the front axle.										

*May use shorter CA with model 437A or 446A, depending upon bed length.
†Estimated axle scale weights prior to installation of crane, stabilizers, and subbase if required for 85% stability.

National Series 400A Accessories

Every Series 400A is part of the National Lifting System. The National Lifting System can equip your 400A to do more than just lift or handle materials, it lets you equip your truck-mounted crane to perform the functions of a whole fleet of specialized vehicles, and at a fraction of the cost.

Because your 400A can do so many jobs from start to finish, you save time, money, and manpower on almost every job you do. You'll find you can do more, faster, with less equipment. And that's money in your pocket.

Get the most from your National 400A. Make it more than just a crane with cost-efficient, hard-working accessories from the National Lifting System.

Note: Weights of all accessories attached to the boom or loadline of the crane must be deducted from the effective lifting capacity.

Consult your dealer for specific accessory availability. Some accessories cannot be used in combination with other accessories and/or certain boom/jib combinations.

Caution
Do not operate crane booms, jib extensions, any accessories, or loads within 10 feet (3m) of live power lines. Do not exceed jib capacities at any reduced boom lengths.

Remote Control

National offers one-hand remote control for your Series 400A. Ideal for use where precise control and total load visibility are required.

Fine metering and instant response mean operators can position loads or work platforms easily.

National's remote controls are built with solid state circuitry and few working parts. They are designed for reliability.

Available in two models: R4 with tilt, turn, telescope and winch functions, and R3 with lift, turn, and telescope only. R3 should be used to control cranes from basket.

A priority control valve, operated by a trigger on the remote control unit, regulates oil flow and gives you fingertip speed control over all crane functions.

National's remote control is the lightweight, easy-to-use way to add extra versatility to your crane. Consult your dealer or the factory for availability.

Model R3

Tilt, turn and telescope

Model R4

Tilt, turn, telescope and winch

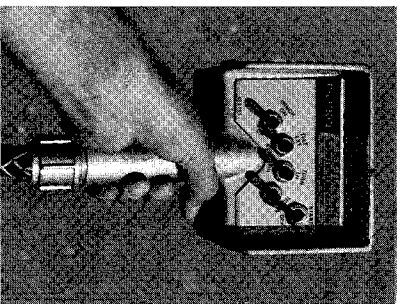

One Person Basket

Strong, lightweight fiberglass basket with 300-pound (136.1kg) capacity puts personnel where you want them for tough maintenance and installation jobs. Optional dual basket bracket for two-basket operation on main boom. (Note: Jib will accommodate only one basket.)

Easy on-off. Safety belts included. With basket(s) attached to the crane, the crane must not be operated at a position where the crane load chart shows less than the following capacities:

- One fiberglass basket — 550 pounds (249.5kg)
- Two fiberglass baskets — 1,100 pounds (499kg)

Model B1

Model B1-L

With lock

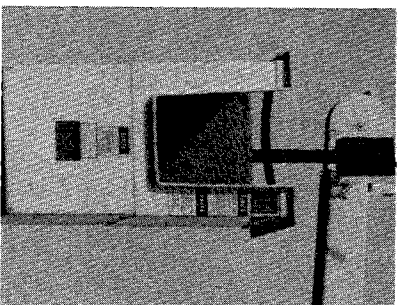

Personnel Platform

This extra strength 3 x 6 foot steel platform will carry up to 1,000 (453.6kg) pounds and operate at working heights up to 70 feet (21.3m). It is hydraulically self-leveling and protected by safety valves. Safety belts included. Fold down sides standard. Optional manual rotator available for precise placement of the platform.

Easy-to-operate crank rotates the platform through a dependable chain drive. Continuous rotation. Looks in position.

The personnel platform must not be operated in load rated areas where the load chart shows capacities less than 2,000 pounds (907.2kg) on Model SLP and 2,200 pounds (997.9kg) on Model SLP-R.

Model SLP

Model SLP-R

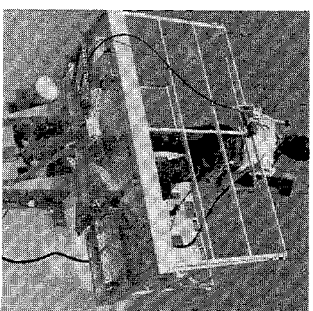

Two Person Basket

Extra capacity steel basket, swing-mounted to self-level. An adjustable, over-center, lever-operated friction brake for stability and locking. Safety belts included. The basket must not be used in load-rated areas where the crane load chart shows capacities less than 1,150 pounds (521.6kg). The maximum capacity of the basket is 500 pounds. (226.8kg)

Model BS-1

5-ft. (1.5m) yoke

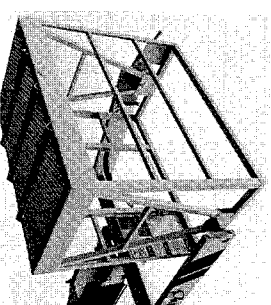

Stabilizers

We offer a complete range of front and rear stabilizers with hydraulic vertical and horizontal motion. All cylinders are fully enclosed for protection against dirt and on-the-job damage.

Stabilizers

Vertical Travel..... 20"
Ground Penetration (38" Frame Height)..... 8"
Operation..... All-Hydraulic
Span..... 10'



Rear Mounted (Model ASH)

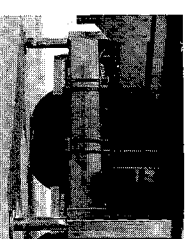

Rear Mounted (Models RSH-15/18/25)



Front Mounted (Model SFO Fixed)*

Controls All stabilizers noted above can be operated from either crane control station

*The SFO, a single front mounted hydraulic stabilizer, is not designed to lift the vehicle, but will provide stability for the vehicle after it has been leveled. The SFO has a 25" vertical stroke.

Cross-frame Outriggers

Extended Span 15'6"
Retracted Span 7'11"
Vertical Travel 25"
Over-Frame 18"
Under-Frame 18"
Ground Penetration (38" Frame Height) 10"
Mounting Space 60"
Crane/Outrigger 24"
Outrigger Only 24"
Mounting Behind cab at rear of chassis or both

Model 4HO

Hydraulic Oil Cooler

High duty cycle applications may require this option, which is designed to automatically cool the hydraulic oil.

Model HOC

Loose Material Clam Bucket

Increase the flexibility of your National crane with a National clam bucket. Use this versatile accessory to load or move up to 2/3 cubic yard of loose materials with each bite. Hooks easily to loadline, comes with 50 feet of hydraulic hose on automatic reel and quick-connect fittings. Extension hoses are required for use with jibs. Just position the load where you want it and open the bucket.

Model LMC

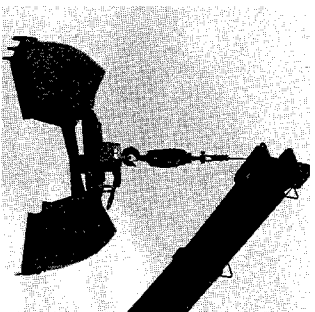

Pallet Fork

Turns your Series 400A into a versatile, payload-packing fork lift. Great for delivering palletized material right where you want it. 4,400 lbs. (1,996kg) capacity with adjustable throat and teeth. Handles most loads with ease.

Capacity: 4,400 lbs. at 20" center
Throat Opening: (adjustable) 41" to 65"
Tooth Length: 38"
Tooth Width: 33.5" to 57" min. max. (outside to outside)
Weight: 350 lbs.

Model MKF

(Manual leveling, adjustable throat)

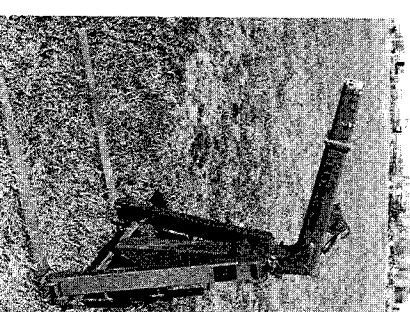

Capacity Alert System

National offers two capacity alert options: the audible-visual capacity alert system is designed to alert the operator when he reaches a maximum capacity condition on the crane structure. This system activates the truck horn when the capacity load is exceeded on the main boom.

The hydraulic capacity alert system is hydraulically operated, maximum capacity sensing device that is designed to stop all of the normal crane functions that cause overload when maximum capacity is exceeded on the main boom. Neither of these systems is applicable to jib and stability capacities.

Model AAS

(Audible capacity alert system)

Model HAS

(Hydraulic capacity alert system)

High Pull Planetary Winch

Extra capacity, heavy-duty winch with planetary gear drive for smoothness and strength.

Model PD-12

National Series 400A Boom Rests

National Series 400A Specifications

Cranes are tough when they're in use, but they can be severely damaged during travel from job to job. The only way a crane can be protected from this type of wear and damage is a strong, solid, boom rest.

Boom Rests

- Add years to the life of your crane
- Reduce stress on the crane frame
- Protect rotation gear from transit damage
- Remove stress from truck frame
- Spread crane load more evenly

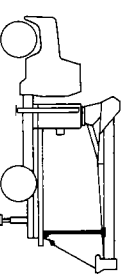

Horizontal rear bed mount for greater load space

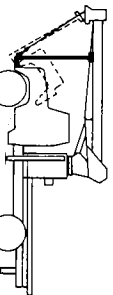

Front mount for trucks with tilting hoods

Larger Front Axle Rating Required.

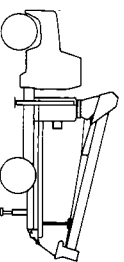

Low-profile rear bed mount for lower center of gravity

- Reduce maintenance and down time.

In addition, boom rests are required to provide a positive way to immobilize your crane for transit.

National Crane supplies five heavy-duty boom rests for strong, sure protection of your crane. There is a quality National boom rest to fit your mounting configuration. All National Cranes must be fitted with a boom rest. All factory mounted cranes will be supplied with a boom rest. NOTE: Only shorter booms can be stowed forward.

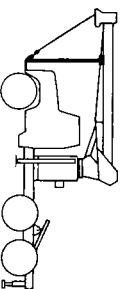

Tractor/trailer front mount

Larger Front Axle Rating Required.

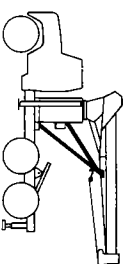

Tractor/trailer rear mount

General Construction: Low-alloy, high strength steel, including T-1, Ex-Ten, Stress-proof, Hi-Yield, and other steels combined with special, low-hydrogen welding techniques wherever advantageous. Standard color: *National Ivory*.

Frame: Box construction. Bolt-on truck frame mounting brackets form base for crane frame and subbase attachment. Rotation bearing, gearbox, and level indicator mounting surfaces are precision machined after welding to ensure accurate alignment and flat surfaces for prolonged life.

Turret: Fabricated, rigid structure, well-braced for stability. The bearing surface is machined and the pin holes are bored after welding to ensure accurate alignment and flat surfaces for prolonged life.

Rotation: 375° non-continuous. Rotational force 141,000 in.-

lbs. (299,000 in.-lbs. breaking strength). Turret rotation is by hydraulic orbit motor and planetary gearbox driving a pinion. The turret rotates on a ball bearing race. Spring-applied hydraulic release brake provides positive, no-drift lateral positioning.

Outriggers: "X" frame box-type 16-4-foot span (center of pad at ground level) moves out-and-down, will not bind when raising or lowering truck. Can be positioned to 9 inches below ground level when mounted on truck with a frame height of 38 inches. Outrigger cylinders are equipped with butt-mounted, safety check valves. Equipped with extra large pads to reduce ground pressure loading and for greater stability in soft footing.

Tilt: Double-acting hydraulic cylinder raises and lowers the boom. Butt-mounted, safety holding valve prevents the boom from falling in the event of hose failure. Tough, field-

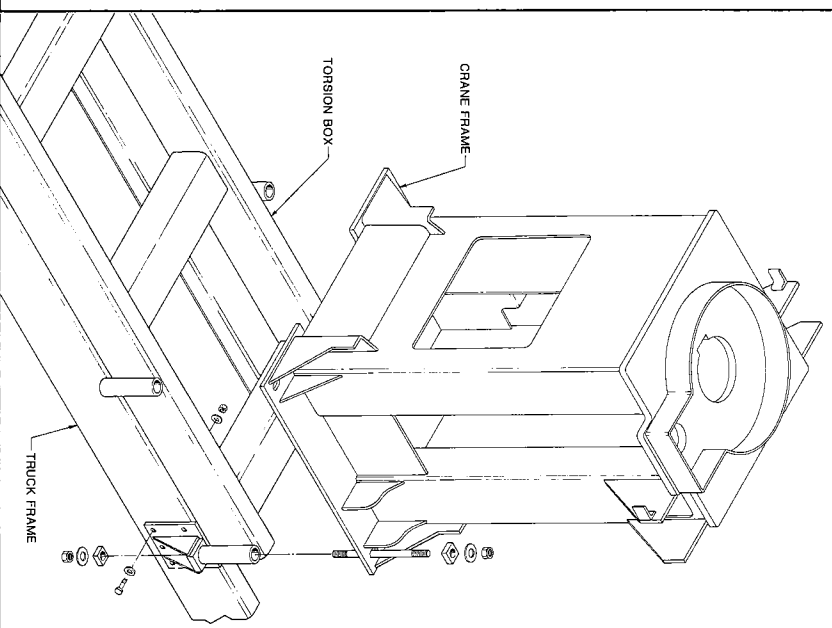

tested bearings in tilt, cylinder and boom pivot combined with micro-honed pins provide long life with reduced maintenance.

Boom:

Boxed construction. Telescopes hydraulically proportionally under rated load on nylon plates impregnated with molybdenum disulfide on all sides of boom, permitting maximum loads to be extended at greater radii. Holding valves prevent retraction except under power.

Controls:

Dual side, stand-up, with operator platform and foot accelerator identical on both sides. Simultaneous operation of load-line and other operations standard. Horn and stop switch on both sides. Controls easily removable for maintenance.

Winch:

Hydraulic motor with planetary gear reduction, brake, and counterbalance valve for "power down" load lowering. * 6,835-pound bare drum, single line pull available with 195 feet of 1/2" diameter; 29,200-pound breaking strength on the standard rotation resistant loadline. Optional 1/2" diameter, 23,000-pound breaking strength 6 x 25 IWRC loadline is available. Optional planetary winch is available with 10,200 pounds bare drum, single line pull, 220 feet of 9/16" diameter, rotation resistant, 37,000-pound breaking strength loadline or 9/16" diameter, 25 IWRC loadline with 29,750-pound breaking strength.

*Because of ANSI safety factor requirements, the standard rotation resistant wire rope is rated at 5,840-pound, 5:1, single line pull and the optional 6 x 25 IWRC wire rope is rated at an 8,400-pound, 3.5:1, single line pull.

Pump: One Vickers, high-pressure, high speed, balanced vane, replaceable cartridge-type tandem pump independently

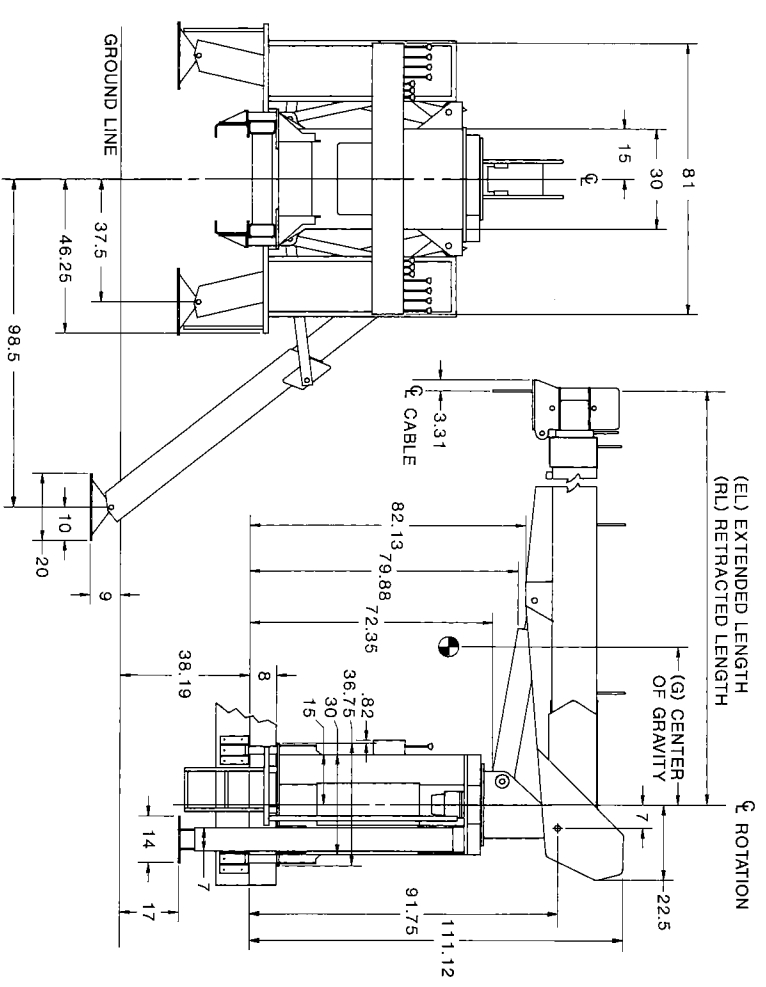

G CENTER OF GRAVITY

Series	RL	EL	G	*Dry Weight	*W/Oil Weight
456A	21'11"	56'	47"	7,000 lbs.	8,000 lbs.
446A	18'7"	46'	38"	7,400 lbs.	7,700 lbs.
437A	15'7"	37'	30"	7,050 lbs.	7,325 lbs.
428	12'7"	28'	23"	6,850 lbs.	7,150 lbs.

*Above weights do not include subbase, rear stabilizers, jibs, PTO, pump, boom rests, or options. Standard subbase weight: 1,225 pounds. Rear stabilizer weight: 550 pounds. Subbase dimension: 35" wide x 254" long x 8" high.

providing 25 gpm to winch, and 12 gpm to crane for smooth, fast, simultaneous operation.

Cylinders: Shaft packing: Polyurethane U-cup type. Shafts Hi-Yield, stress-relieved, chrome-plated. Piston sets: Polyurethane U-cup and rider construction. Cylinder barrels: Micro-honed tubing, butt-mounted, safety check valves.

Valves: Four-way, spring-centered, spool-type with independent relief valves set at 2,850 psi

(maximum 3,050 psi on winch system) to protect circuits against overload.

Hose: All high-pressure hose is wire-braid reinforced, having a minimum safety factor of 4 to 1.

Operating Speeds: Rotation 375°, 35 seconds. Boom up, -15° to 80°, 20 seconds. Boom down, 80° to -15°, 16 seconds. Boom extend: 36 fpm. Boom retract: 43 fpm. When using remote control, crane function speeds will be reduced by 50% to

assure smooth operation. (Speeds above assume no load with 12 gpm oil flow on boom and 25 gpm on winch.)

Oil tank Capacities: 32-gallon supply tank. Normally mounted on subframe. Sight gauge, clean-out, and magnetic plug. System has an approximate 45-gallon total capacity.

Filter: 10-micron, replaceable-cartridge, return-line filter. 100% filtration.