

550-TC

TRUCK CRANE
SPECIFICATIONS

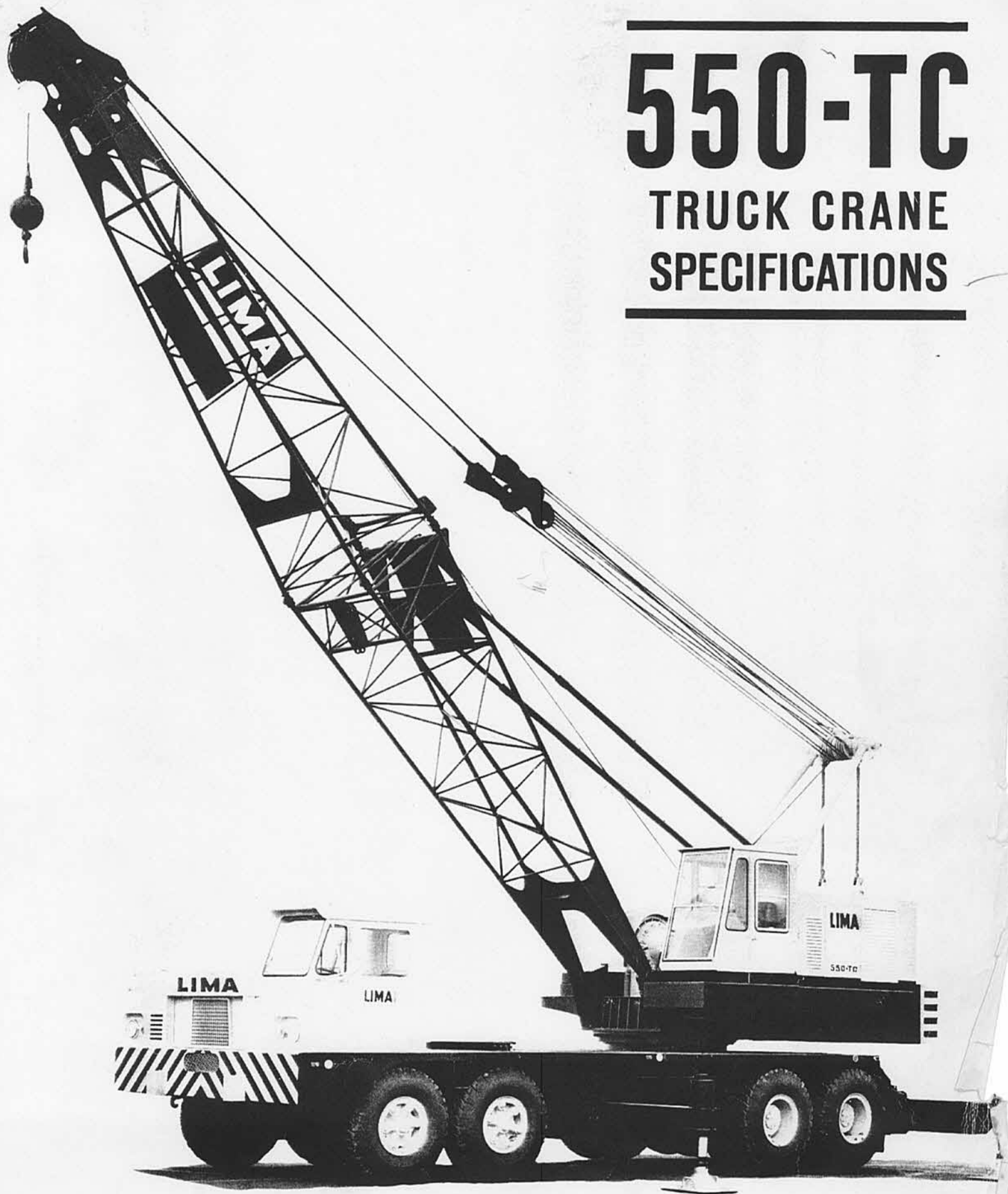

CRANE LIFTING CAPACITIES

60 Ton Class 15-325			Lifting Capacities 85% of Tipping Loads												Maximum CWT.-18,400#											
Boom			On Outriggers		On Tires		Boom			On Outriggers		On Tires		Boom			On Outriggers		On Tires							
Lgth.	Rad.	∠°	Side	Rear	Lgth.	Rad.	∠°	Side	Rear	Lgth.	Rad.	∠°	Side	Rear	Lgth.	Rad.	∠°	Side	Rear	Lgth.	Rad.	∠°	Side	Rear		
40'	15	73	120,000*	55,175	57,925	110'	30	76	49,800	20,475	23,000	150'	55	70	19,450	7,650	9,175	180'	85	63	9,175	---	---	---	---	---
	20	65	89,700*	36,800	39,900		35	73	39,150	16,500	18,750		60	68	17,025	6,525	7,925		90	61	8,250	---	---	---	---	---
	25	57	67,375	27,275	30,125		40	70	32,000	13,625	15,650		65	66	15,050	5,575	6,875		95	59	7,450	---	---	---	---	---
	30	48	50,050	21,450	24,000		45	68	26,900	11,450	13,300		70	64	13,375	4,775	6,000		100	57	6,725	---	---	---	---	---
	35	37	39,600	17,500	19,800		50	65	23,050	9,775	11,450		75	61	11,975	4,100	5,250		105	56	6,075	---	---	---	---	---
	40	22	32,600	14,675	16,725		55	62	20,050	8,400	9,950		80	59	10,775	3,500	4,575		110	54	5,500	---	---	---	---	---
50'	15	76	109,750*	55,000	57,850	120'	30	76	49,800	20,475	23,000	150'	55	70	19,450	7,650	9,175	180'	85	63	9,175	---	---	---	---	---
	20	70	89,450*	36,625	39,775		35	73	39,150	16,500	18,750		60	68	17,025	6,525	7,925		90	61	8,250	---	---	---	---	---
	25	64	67,350	27,075	29,975		40	70	32,000	13,625	15,650		65	66	15,050	5,575	6,875		95	59	7,450	---	---	---	---	---
	30	57	50,025	21,250	23,825		45	68	26,900	11,450	13,300		70	64	13,375	4,775	6,000		100	57	6,725	---	---	---	---	---
	35	50	39,550	17,300	19,625		50	65	23,050	9,775	11,450		75	61	11,975	4,100	5,250		105	56	6,075	---	---	---	---	---
	40	42	32,500	14,475	16,550		55	62	20,050	8,400	9,950		80	59	10,775	3,500	4,575		110	54	5,500	---	---	---	---	---
60'	15	79	109,500*	54,925	57,725	130'	30	76	49,800	20,475	23,000	150'	55	70	19,450	7,650	9,175	180'	85	63	9,175	---	---	---	---	---
	20	74	89,125*	36,475	39,600		35	73	39,150	16,500	18,750		60	68	17,025	6,525	7,925		90	61	8,250	---	---	---	---	---
	25	69	67,325	26,925	29,800		40	70	32,000	13,625	15,650		65	66	15,050	5,575	6,875		95	59	7,450	---	---	---	---	---
	30	63	50,000	21,050	23,625		45	70	26,750	11,250	13,075		70	64	13,375	4,775	6,000		100	57	6,725	---	---	---	---	---
	35	58	39,450	17,100	19,400		50	67	22,900	9,550	11,225		75	61	11,975	4,100	5,250		105	56	6,075	---	---	---	---	---
	40	52	32,400	14,250	16,325		55	64	19,875	8,175	9,725		80	59	10,775	3,500	4,575		110	54	5,500	---	---	---	---	---
70'	15	76	109,750*	55,000	57,850	140'	30	76	49,800	20,475	23,000	150'	55	70	19,450	7,650	9,175	180'	85	63	9,175	---	---	---	---	---
	20	70	89,450*	36,625	39,775		35	73	39,150	16,500	18,750		60	68	17,025	6,525	7,925		90	61	8,250	---	---	---	---	---
	25	64	67,350	27,075	29,975		40	70	32,000	13,625	15,650		65	66	15,050	5,575	6,875		95	59	7,450	---	---	---	---	---
	30	57	50,025	21,250	23,825		45	68	26,900	11,450	13,300		70	64	13,375	4,775	6,000		100	57	6,725	---	---	---	---	---
	35	50	39,550	17,300	19,625		50	65	23,050	9,775	11,450		75	61	11,975	4,100	5,250		105	56	6,075	---	---	---	---	---
	40	42	32,500	14,475	16,550		55	62	20,050	8,400	9,950		80	59	10,775	3,500	4,575		110	54	5,500	---	---	---	---	---
80'	15	79	109,500*	54,925	57,725	150'	30	76	49,800	20,475	23,000	150'	55	70	19,450	7,650	9,175	180'	85	63	9,175	---	---	---	---	---
	20	74	89,125*	36,475	39,600		35	73	39,150	16,500	18,750		60	68	17,025	6,525	7,925		90	61	8,250	---	---	---	---	---
	25	69	67,325	26,925	29,800		40	70	32,000	13,625	15,650		65	66	15,050	5,575	6,875		95	59	7,450	---	---	---	---	---
	30	63	50,000	21,050	23,625		45	70	26,750	11,250	13,075		70	64	13,375	4,775	6,000		100	57	6,725	---	---	---	---	---
	35	58	39,450	17,100	19,400		50	67	22,900	9,550	11,225		75	61	11,975	4,100	5,250		105	56	6,075	---	---	---	---	---
	40	52	32,400	14,250	16,325		55	64	19,875	8,175	9,725		80	59	10,775	3,500	4,575		110	54	5,500	---	---	---	---	---
90'	15	76	109,750*	55,000	57,850	160'	30	76	49,800	20,475	23,000	150'	55	70	19,450	7,650	9,175	180'	85	63	9,175	---	---	---	---	---
	20	70	89,450*	36,625	39,775		35	73	39,150	16,500	18,750		60	68	17,025	6,525	7,925		90	61	8,250	---	---	---	---	---
	25	64	67,350	27,075	29,975		40	70	32,000	13,625	15,650		65	66	15,050	5,575	6,875		95	59	7,450	---	---	---	---	---
	30	57	50,025	21,250	23,825		45	68	26,900	11,450	13,300		70	64	13,375	4,775	6,000		100	57	6,725	---	---	---	---	---
	35	50	39,550	17,300	19,625		50	65	23,050	9,775	11,450		75	61	11,975	4,100	5,250		105	56	6,075	---	---	---	---	---
	40	42	32,500	14,475	16,550		55	62	20,050	8,400	9,950		80	59	10,775	3,500	4,575		110	54	5,500	---	---	---	---	---
100'	15	79	109,500*	54,925	57,725	170'	30	76	49,800	20,475	23,000	150'	55	70	19,450	7,650	9,175	180'	85	63	9,175	---	---	---	---	---
	20	74	89,125*	36,475	39,600		35	73	39,150	16,500	18,750		60	68	17,025	6,525	7,925		90	61	8,250	---	---	---	---	---
	25	69	67,325	26,925	29,800		40	70	32,000	13,625	15,650		65	66	15,050	5,575	6,875		95	59	7,450	---	---	---	---	---
	30	63	50,000	21,050	23,625		45	70	26,750	11,250	13,075		70	64	13,375	4,775	6,000		100	57	6,725	---	---	---	---	---
	35	58	39,450	17,100	19,400		50	67	22,900	9,550	11,225		75	61	11,975	4,100	5,250		105	56	6,075	---	---	---	---	---
	40	52	32,400	14,250	16,325		55	64	19,875	8,175	9,725		80	59	10,775	3,500	4,575		110	54	5,500	---	---	---	---	---

CAPACITIES BELOW INCL. JIB
(See Jib Data)

Capacities Over Side or Rear on Outrigger

Boom Lgth.	Jib Rad.	Standard Jib	Heavy Duty Jib
190' (170' +20') Std. or H.D.	45	16,000	26,000
	50	16,000	22,250
	60	16,000	16,525
	70	12,800	12,700
	80	10,100	9,950
	90	8,075	7,900
	100	6,500	6,300
	110	5,225	5,025
	120	4,200	3,975
	130	3,325	3,100
200' (180' +20') OR H.D.	140	2,600	2,350
	150	1,975	1,725
	45	16,000	26,000
	50	16,000	22,125
	60	16,000	16,375
	70	12,625	12,525
210' (180' +30') STD. OR H.D.	80	9,925	9,775
	90	7,900	7,725
	100	6,325	6,125
	110	5,050	4,825
	120	4,025	3,775
	130	3,150	2,900
220' (180' +40') +30') +40') +60') H.D.	140	2,425	2,175
	150	1,800	1,525
	50	10,000	16,350
	60	10,000	12,500
	70	10,000	9,750
	80	9,900	7,700

This capacity chart is based upon:

1. Loads marked by * are the maximum allowable loads permitted by structural strength of the parts, and are not based on the stability of the machine.
2. All other loads are based on stability, and do not exceed 85% of tipping in the least stable direction.
3. Machine to be leveled on firm solid support; shock and size loading are to be prevented.
4. Machine equipped with hydraulic outriggers.
5. All hook blocks, lifting tackle, or jib attachments are considered a part of the load to be lifted.
6. "With Outriggers," capacities are based upon having all tires within boundary of outriggers free of ground.
7. "Less Outriggers," capacities are not recommended for traveling (refer to Lima for travel load rating).
8. Exceeding these capacities, or altering the counterweight nullifies all warranties.
9. Loads should not be handled over front of carrier.
10. Capacities above dotted line require a wire rope of length greater than furnished as standard with the machine.

** Capacities per SAE Code J765

*** Class Designation per U.S. Department of Commerce Standards

BLH LIMA 550-T DRAGLINE AND CLAMSHELL WORKING RANGES

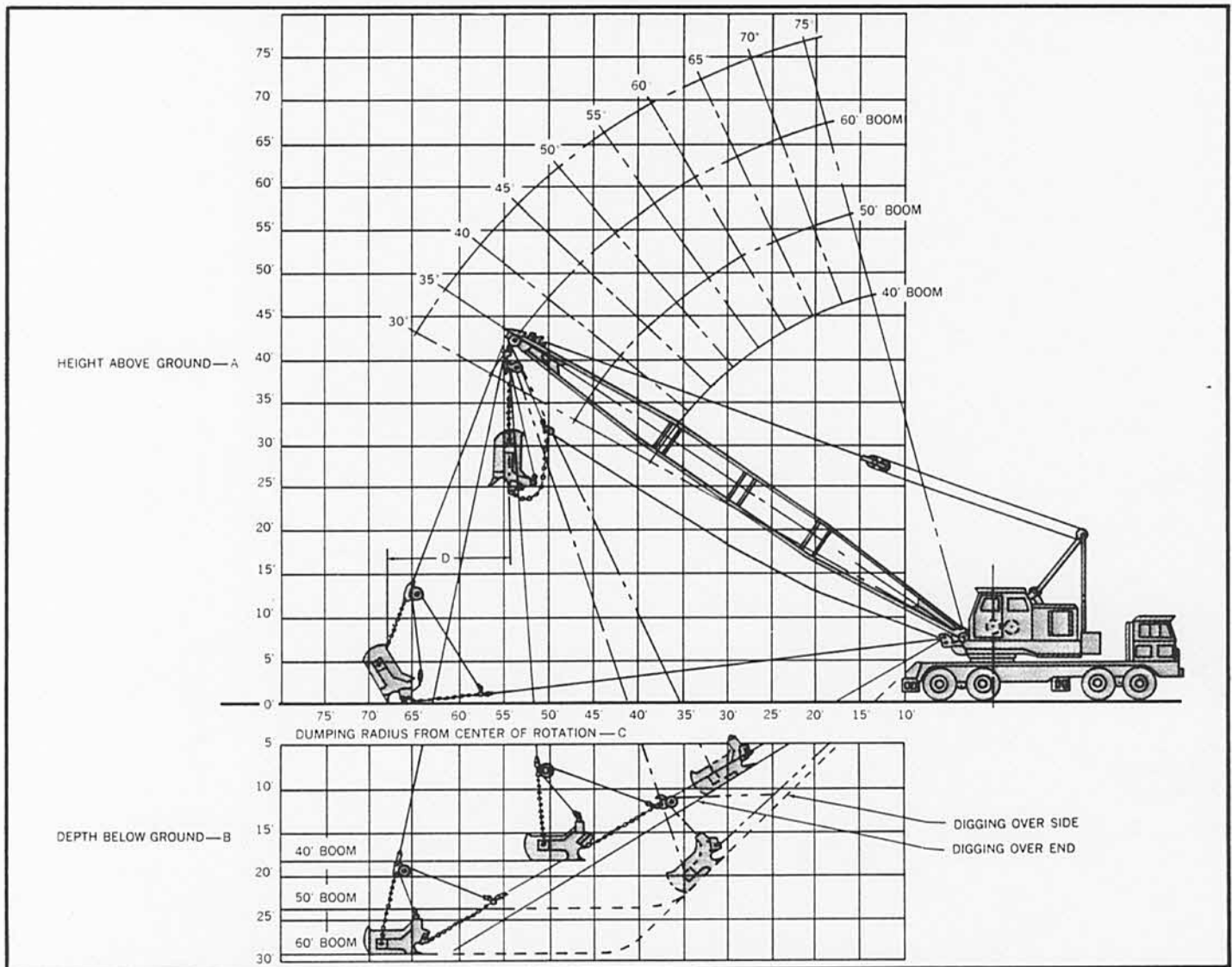

CHART REFERENCE AND NOTES

B—Digging depth—digging depths obtained are with standard wire rope lengths. These depths cannot be guaranteed because of type of material, size and type of bucket and digging conditions.

C—Dumping radius—depends upon boom length and boom angle. (See chart above.)

D—Bucket throw—depends upon skill of the operator and working conditions. (Usually $\frac{1}{3}$ of the dumping height.)

DRAGLINE - CLAMSHELL - MAGNET CAPACITIES WITH OR LESS OUTRIGGERS

Load Radius	Boom Length and Boom Angle					
	40'	∠	50'	∠	60'	∠
20'	28,900	65	28,850	70	28,800	74
25'	21,400	57	21,350	64	21,250	69
30'	16,850	48	16,750	57	16,650	63
35'	13,800	37	13,650	50	13,500	58
40'	11,550	22	11,400	42	11,300	52
45'			9,750	33	9,600	46
50'			8,400	20	8,250	38
55'					7,200	30
60'					6,350	18

NOTE: To maintain normal operating speeds the loaded bucket or magnet weight must not exceed 9,000#. Loads greater than 9000# require multiple reeving of the hoist line. Digging and footing conditions, together with skill of the operator, will determine whether or not the maximum loading conditions stated above can be used.

MATERIAL WEIGHTS

Material To Be Moved		Weight Per		Material To Be Moved		Weight Per	
		Cu. Ft.	Cu. Yd.			Cu. Ft.	Cu. Yd.
Coal	Broken, Loose	55	1485	Gypsum	Crushed 1" to 5"	100	2700
Coal	Solid	84	2268	Iron Ore		170	4590
Clay	Damp, Plastic	130	3510	Limestone	Loose	96	2592
Clay & Gravel	Dry	105	2835	Rock	Trap Rock Crushed	110	2970
Earth	Loam, Loose	80	2160	Sand	Damp, Packed	130	3510
Earth	Loam, Packed	100	2700	Sand	Dry	100	2700
Earth	Mud, Packed	110	2970	Stone	Loose	100	2700
Gravel		100	2700	Slag	Wet, Granulated	58	1566

Refer To Manufacturer's Information For Weight of Dragline or Clamshell Buckets.

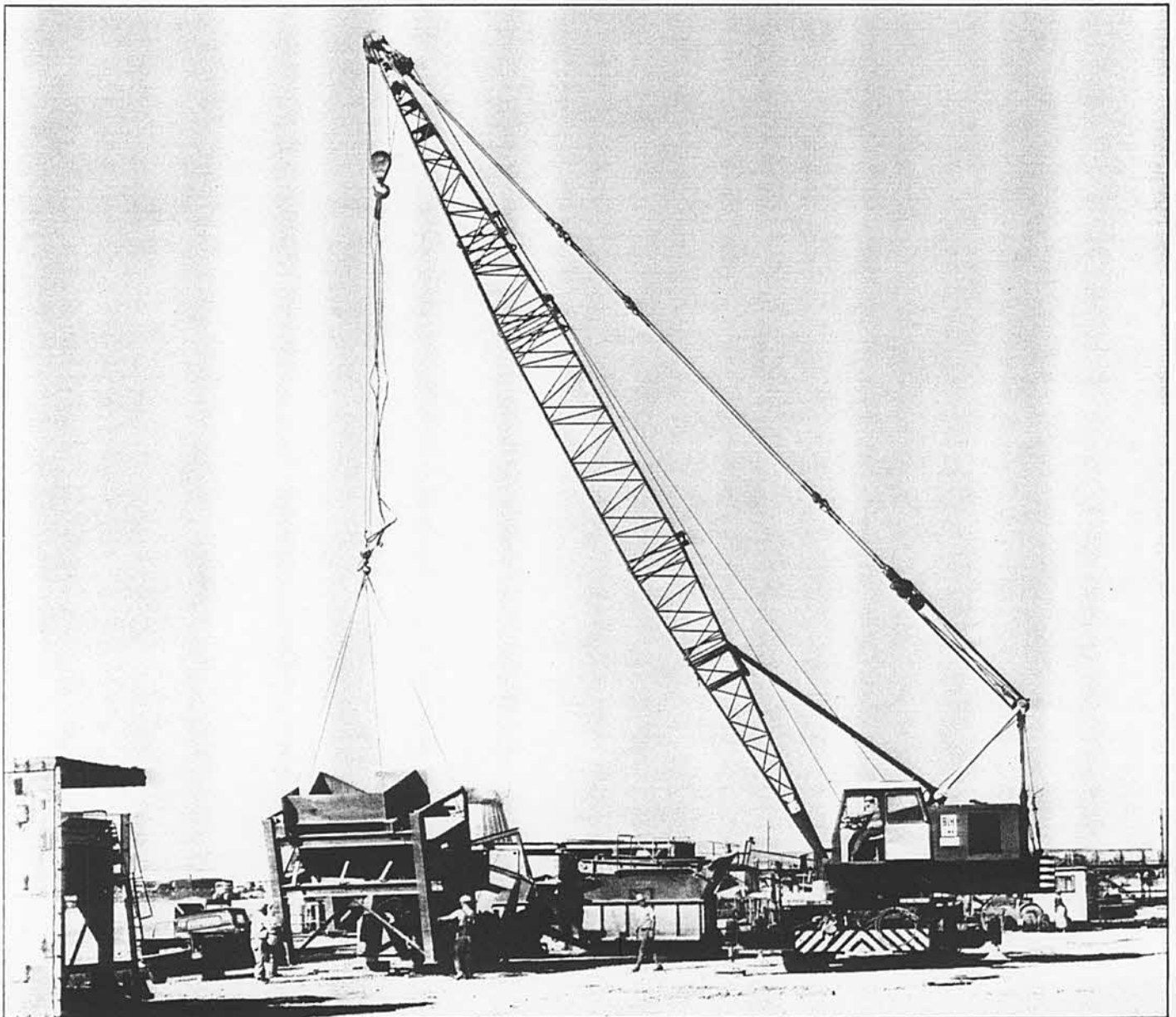

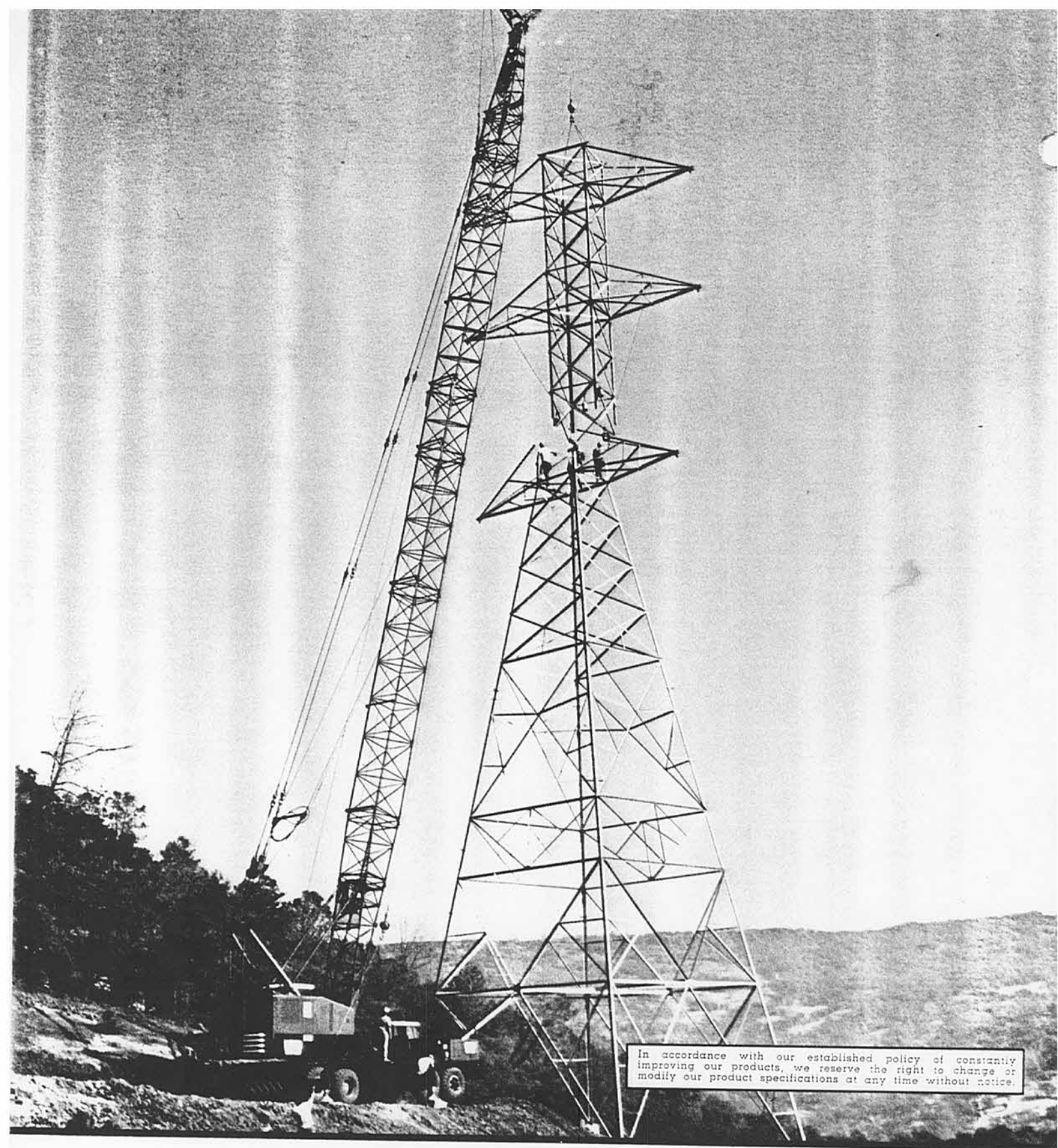

In accordance with our established policy of constantly improving our products, we reserve the right to change or modify our product specifications at any time without notice.

CLARK
EQUIPMENT







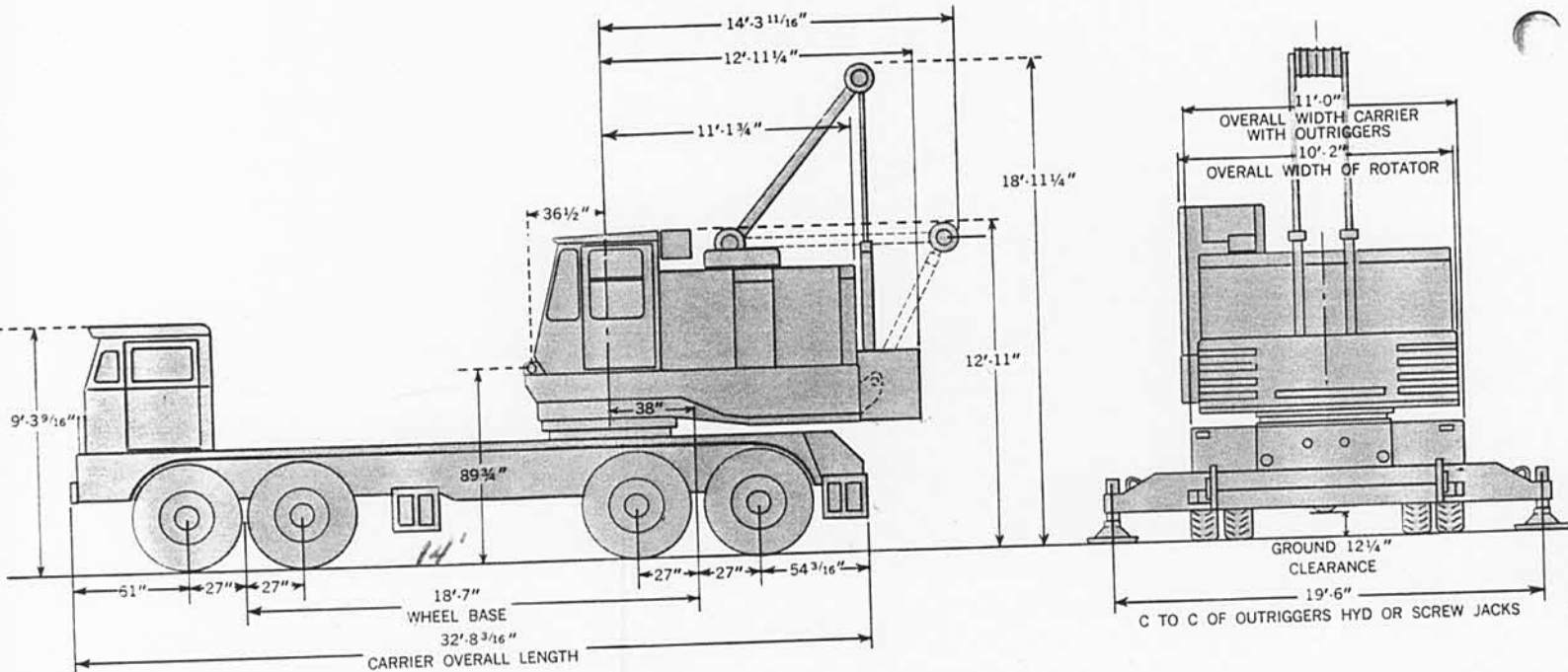

CLARK EQUIPMENT COMPANY
LIMA DIVISION
LIMA, OHIO 45802

Form SPS-550-TC 2-73 4M Litho in U.S.A.

CLEARANCE AND DIMENSIONS



WEIGHTS OF COMPONENT PARTS

<p>CARRIER T-1</p>  <p>Total Weight of Carrier with Standard Gasoline Engine and Manual Outrigger Beams (No Screw Jacks or Floats) 46,600 Lbs.*</p>	<p>ROTATOR R-1</p>  <p>Total Weight of Rotating Assembly with Standard Gasoline Engine and Counterweight 43,260*</p>	<p>CRANE ATTACHMENT A-2</p>  <p>Total Weight of Crane Attachment with 40' Tubular Boom; 4 Point Sheaves; 10 Part Crossover, Boom Stop, Boom Angle Indicator, and Necessary Cables 6,585 lbs.*</p>	<p>MISCELLANEOUS</p> <p>Hook Block 1000 Lbs. Boom Stop 540 Lbs. Ball & Hook (5 Ton)..... 340 Lbs.</p> <p>BOOM HOIST CABLES:</p> <p>Crossover and Basic Pendants— 10 Part Line 810 Lbs. 12 Part Line 840 Lbs. Mid-Point Suspension 150' & 160' Boom 415 Lbs. 170' & 180' 475 Lbs.</p>															
<p>OUTRIGGER BOXES, BEAMS AND FLOATS</p> <p>MANUAL OUTRIGGERS:</p> <p>Outrigger Box (2) ... 2245 Lbs. Each Outrigger Beams (4) 935 Lbs. Each Screw Jacks (4) 65 Lbs. Each Floats (4) 50 Lbs. Each</p>  <p>HYDRAULIC OUTRIGGERS:</p> <p>Outrigger Box (2) . . 2245 Lbs. Each Outrigger Beams (4) 1355 Lbs. Each Floats (4) 65 Lbs. Each Note: Also add 670 Lbs. for miscellaneous items when figuring truck weight with hydraulic outriggers.</p> <p>BUMPER CWT. 6600 Lbs.</p> 	<p>For Third Drum (Add) 840 Lbs. For Power Load Lowering (Add) 340 Lbs. For Full Width Front Drum w/PLL Add & Ratchet 1065 Lbs.</p> <p>GANTRIES:</p> <p>Telescopic Back-Hitch Gantry—1975 Lbs.</p>  <p>Basic Gantry—760 Lbs.</p> <p>Note: Weight of Gantry is Included in Rotating Assembly</p> <p>ROTATING REAR CWT. 18370 Lbs.</p> 	<p>BOOM & BOOM EXTENSIONS</p> <p>20' Point Section 1985 Lbs.* 20' Base Section 1585 Lbs. 10' Extension 745 Lbs. 20' Extension 1135 Lbs. 30' Extension 1600 Lbs. 40' Extension 1970 Lbs. *Main Sheave and Guidesheaves Included in Point Section Weight All Extension Weight Includes Pendants</p>  <p>STANDARD JIB</p> <p>20' Basic Jib Assembly on Basic Boom Including Front Guy Cable & Strut... 1,540 Lbs. 10' Jib Extension 270 Lbs. Maximum Jib Length 40 Ft. NOTE: For each additional 10' of boom length add 30 lbs. to Jib Assembly</p>	<table border="1"> <thead> <tr> <th>Generating Cables</th> <th>Basic Weight</th> <th>For Each Additional 10 Ft. of Boom—Add</th> </tr> </thead> <tbody> <tr> <td>Crane (Main Hoist)</td> <td>580 Lbs.</td> <td>—</td> </tr> <tr> <td>Crane (Aux. Hoist)</td> <td>100 Lbs.</td> <td>20 Lbs.</td> </tr> <tr> <td>Dragline</td> <td>170 Lbs.</td> <td>25 Lbs.</td> </tr> <tr> <td>Clamshell</td> <td>240 Lbs.</td> <td>20 Lbs.</td> </tr> </tbody> </table> <p>A-3 Dragline Attachment (Less Bucket)</p> <p>Tubular Boom 4645 Lbs. Deck mounted Fairlead 745 Lbs. Additional Rotating Parts .. 660 Lbs. Total Attachment Weight .. 6050 Lbs.</p> <p>A-4 Clamshell Attachment (Less Bucket)</p> <p>Tubular Boom 4820 Lbs. Tagline Winder 325 Lbs. Additional Rotating Parts .. 660 Lbs. Total Attachment Weight .. 5805 Lbs.</p>	Generating Cables	Basic Weight	For Each Additional 10 Ft. of Boom—Add	Crane (Main Hoist)	580 Lbs.	—	Crane (Aux. Hoist)	100 Lbs.	20 Lbs.	Dragline	170 Lbs.	25 Lbs.	Clamshell	240 Lbs.	20 Lbs.
Generating Cables	Basic Weight	For Each Additional 10 Ft. of Boom—Add																
Crane (Main Hoist)	580 Lbs.	—																
Crane (Aux. Hoist)	100 Lbs.	20 Lbs.																
Dragline	170 Lbs.	25 Lbs.																
Clamshell	240 Lbs.	20 Lbs.																

*Per Current Price List Description

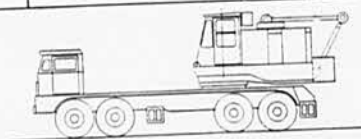

TOTAL WEIGHT OF T-1, R-1 & A-2 = 96,445 Lbs.
TOTAL WEIGHT OF T-1 & R-1 = 89,860 Lbs.

WORKING WEIGHTS (Approximate in pounds)

HYDRAULIC OUTRIGGERS	
LIFTING CRANE	99,055 Lbs.
CLAMSHELL (Less Bucket)	98,275 Lbs.
DRAGLINE (Less Bucket)	98,520 Lbs.

AXLE LOADING AND WEIGHTS

EQUIPPED AS FOLLOWS: 14:00 x 20" tires; outrigger beams; 40 ft. tubular boom; G.M. 6171-N power plant truck; G.M. 4-71 with direct drive power plant in rotating assembly. Includes laggings, boom stops and cables. Does not include third drum or power load lowering.

Weight Combinations	Boom Position	With Screw Jack Outriggers & Floats			With Hydraulic Outriggers & Floats		
		Front Tandem	Rear Tandem	Total	Front Tandem	Rear Tandem	Total
COMPLETE MACHINE (CRANE)	F	16,430	80,475	96,905	17,195	81,860	99,055
	R	38,945	57,960	96,905	39,710	59,345	99,055
MACHINE LESS COUNTERWEIGHT	F	24,795	53,740	78,535	25,560	55,125	80,685
	R	24,310	54,225	78,535	25,075	55,610	80,685
MACHINE LESS COUNTERWEIGHT, BOXES, BEAMS AND FLOATS	F	23,260	46,585	69,845	23,760	46,755	70,515
	R	22,775	47,070	69,845	23,275	47,240	70,515
MACHINE LESS COUNTERWEIGHT, BOXES, BEAMS, FLOATS, BOOM POINT SECTION.	F	18,355	49,275	67,630	18,855	49,445	68,300.
	R	26,925	40,705	67,630	27,425	40,875	68,300
MACHINE LESS COUNTERWEIGHT BOXES, BEAMS, FLOATS, COMPLETE BOOM.	F	15,880	48,000	63,880	16,380	48,170	64,550
	R	28,125	35,755	63,880	28,625	35,925	64,550

F—DENOTES BOOM EXTENDED FORWARD

R—DENOTES BOOM EXTENDED REARWARD

NOTE: Any deviation from the equipment listed above will affect the weights shown proportionately and compensation must be made accordingly.

POWER PLANT DATA (CARRIER)

	Make	Model	Fuel	Cyl.	Bore & Stroke	Rated H.P.
TRUCK CARRIER	Cummins	NHF-240	Diesel	6	5½" x 6"	240 @ 2,300
	GM	6171-N	Diesel	6	4¼" x 5"	244 @ 2,300

PERFORMANCE DATA (CARRIER)

Engine Make & Model	Carrier Equipped With 5 Speed Main & 3 Speed Auxiliary Trans.			
	Low Range*		High Range**	
	Grade	MPH	Grade	MPH
Cummins NHF-240	40%	1.3	1.0%	42.1
GM 6171-N	40%	1.3	1.1%	42.1

The above is based on a machine equipped with a 5 speed Fuller main transmission and spicer 3 speed auxiliary transmission with Clark Planetary DB 50-70 axles.

*Based on fully equipped machine weighing 99,055#, with max. engine torque.

**Based on stripped machine weighing 64,550# with max. engine speed.

DESCRIPTIVE DATA (Carrier)

Basic and Optional Components

FRAME: Carrier frame of heavy-duty, all welded construction. Two main members, each of deep box section, are joined together by bumper and box section cross members. Tow hooks, front and rear, 100,000 P.S.I. steel is used in highly stressed members of frame.

SWING CIRCLE: A large diameter, single row, anti-friction bearing assembly with integral swing gear. Bearing is well sealed with close fitting races, eliminating all rocking motion of rotating assembly on carrier.

OUTRIGGER BOXES: The two outrigger boxes are fabricated from steel plates. Boxes are of the pin-on design for ease of removal.

OUTRIGGER BEAMS: Four, box section extensible beams mounted two in each outrigger box are fabricated with 100,000 P.S.I. steel.

HYDRAULIC OUTRIGGERS: Independent control valves for extending each beam and for lowering each hydraulic jack with floats provide precise leveling of truck. Control valve station on carrier at ground level.

REMOTE CONTROLLED CARRIER: Controls provided in cab of rotating assembly that can start, steer, brake, clutch, shift transmission (low and reverse) and control throttle. (Optional.)

FRONT TANDEM SUSPENSION: Front tandem axles are suspended by two alloy steel underslung equalizers, direct-connected to chassis frame. Two radius rods on each axle maintain proper positioning of axles.

FRONT AXLES: Two tubular—high clearance type, rating 17,000 # each. Wheels are mounted on roller bearings.

REAR AXLES: Planetary drive with inter-axle differential. No spin differential is available.

REAR TANDEM SUSPENSION: Rear tandem axles are suspended by two alloy steel underslung equalizers, direct-connected to chassis frame. One torque rod on each axle maintains proper positioning of axles.

WHEELS: Heavy-duty 20 x 10.0 rims, four singles in front, four duals in rear, making a total of twelve wheels.

TIRES: Twelve 14.00 x 20—18 ply rating.

FUEL CAPACITY: 85 gallons.

FENDERS: Fenders are of the combination fender-deck design, providing a flat full width—full length walkway.

SERVICE BRAKES: Air brakes on all wheels. Front brake shoes are 17¹/₄" diameter x 4" wide. Rear brake shoes are 17¹/₄" diameter x 5¹/₂" wide.

SAFETY BRAKES: Spring set, air released brake cylinders on rear axles lock brakes in case of air loss or for parking. An auxiliary air reservoir and controls allow brakes to be released and reapplied several times after loss of regular air supply.

OPERATING BRAKE: A hand-operated air valve applies the service brakes when required for holding the machine when operating on rubber.

STEERING: Hydraulic steering with Ross roller mounted cam and twin lever type steering gear powered by engine driven pump, double acting cylinders and hydraulic control valve built into draglink.

TRANSMISSION: Main transmission is a Fuller Model 5-H-74 with five speeds forward and one reverse.

AUXILIARY TRANSMISSION: Spicer Model 8031-C with three speeds giving 15 speeds forward and three reverse.

CLUTCH: Lipe Rollway 14"-2-DPB.

CAB: One-man type, with visor type top. All steel construction, amply ventilated for summer or winter. Adjustable seat. Instrument cluster contains speedometer, odometer, ammeter, oil pressure gauge, water temperature gauge, fuel gauge and pilot light. Instrument panel contains air gauge, light switches, ignition and starter switch.

BUMPER COUNTERWEIGHT: Not to be used to affect lifting capacity. Used only to improve horizontal boom and jib handling abilities. See table, Page 7.

MISCELLANEOUS ACCESSORIES: Inflating hose and tire pressure gauge, boom rest, rear view mirror, two beam headlights, stop and tail light, front, middle and rear marker lights and parking lights, electric directional signals, spare rim with or without tire, air or electric windshield wipers, air and electric dual horns, fender, flaps, heater and defrosters.

POWER PLANT DATA (ROTATOR)

	Make	Model	Fuel	Cyl.	Bore & Stroke	Gross Rated H.P.	Mech. Drive *H.P. @ Governed R.P.M.	Torque Conv. H.P. @ Governed R.P.M.
ROTATING ASSEMBLY	Cummins	H-743-PI60	Diesel	6	5½" x 6"	160 @ 1,800	130 @ 1,800	135 @ 1,800
	GM	4081	Diesel	4	4¼" x 5"	150 @ 2,300	—	130 @ 2,100
	GM	4055C	Diesel	4	4¼" x 5"	150 @ 2,300	127 @ 2,000	—

*Two speed transmission or mechanical drive does not affect H.P. rating.

CLUTCH AND BRAKE DATA

FUNCTION	CLUTCHES				BRAKES			
	Type	Width	Diameter	Area	Type	Width	Diameter	Area
Main Hoist	Band	5"	24"	337 Sq. In.	Band	4½"	30"	338 Sq. In.
Auxiliary Hoist	Band	5"	24"	337 Sq. In.	Band	4½"	30"	338 Sq. In.
3rd Drum Hoist	Band	5"	24"	337 Sq. In.	Band	4½"	30"	338 Sq. In.
Boom Hoist	Band	5"	24"	337 Sq. In.	Band	4½"	30"	338 Sq. In.
Swing	2 Shoe	4½"	24"	290 Sq. In.	Band	4½"	30"	338 Sq. In.
Boom Lowering	Band	4½"	20"	248 Sq. In.				
Load Lowering	Band	4½"	20"	248 Sq. In.	Band*	4"	26"	240 Sq. In.
*Front Drum	Band	5"	24"	337 Sq. In.	Band	4½"	30"	338 Sq. In.

*Full width front drum with planetary load lowering.

LAGGING DATA

Lagging Location	Usage	Lagging P. D.	Lagging Width	Type of Lagging	Eff. Capy. 1st Layer	Maximum Capy. & Layers	Wire Rope Size	Line Speed (F.P.M.)	*Line Pull (Approx.)
L. H. Front	Third Drum	14"	11"	Smooth	45'	464' in 7	¾"	138'	14,500#
R. H. Front	Crane Auxiliary Hoist	16"	14½"	Smooth	71'	569' in 6	¾"	157'	21,000#
R. H. Front	Dragline Drag	16½"	14½"	Grooved	48'	—	7/8"	159'	20,835#
L. H. Rear	Dragline Hoist	16"	14½"	Grooved	48'	—	¾"	157'	21,000#
L. H. Rear	Main Hoist	16"	14½"	Smooth	71'	569' in 6	¾"	157'	21,000#
R. H. Front	Clamshell Holding	16"	14½"	Grooved	48'	—	¾"	157'	21,000#
L. H. Rear	Clamshell Closing	16"	14½"	Grooved	48'	—	¾"	157'	21,000#
R. H. Rear	Boom Hoist	12"	8½"	Smooth	28'	372' in 8	¾"	118'	28,000#
Full Width Front Drum	Main or Aux. Hoist	16"	24"	Smooth	123'	959' in 6	¾"	157'	21,000#

*Line pulls are based on the first layer on drum and full rated engine H.P., see recommended reeving for limitation of single line load.

MISCELLANEOUS DATA (ROTATOR)

Swing Speed	3.0 RPM	Fuel Capacity 210 Gallons
-------------	---------	---------------------------

DESCRIPTIVE DATA (ROTATING ASSEMBLY)

Basic Standard and Optional Components

ROTATING BASE: Fabricated with integral machinery frames. Fuel tank built in.

SHAFTING: All shafting heat treated alloy steel ground to size. Involute splines used extensively.

VERTICAL SWING SHAFT: The vertical swing shaft and pinion is one piece, mounted on ball and roller bearings.

HORIZONTAL SWING SHAFT: This shaft is mounted on anti-friction bearings, geared to the front and rear drum shafts. It supplies power to the vertical swing shaft through a bevel pinion.

SWING BRAKE: A swing brake operates on the outside of the front swing clutch housing for use as a lock brake.

SWING BRAKE WITH SNUBBER: Same as swing brake except an additional control valve on swing lever provided for momentarily holding while setting loads.

JACK SHAFT: This shaft is mounted on ball bearings, and supplies power through a pinion gear to the power lowering shaft. Lube oil pump is belt driven from right hand end of jack shaft.

FRONT DRUM SHAFT: Supported by self-aligning anti-friction bearings and ball bearings. Mounted on the right hand end of this shaft is a swing clutch geared to the horizontal swing shaft. The right hand drum is a split lagging design, either smooth or grooved. All drums are mounted on ball bearings. Refer to "lagging data" table for specifications.

REAR DRUM SHAFT: Supported by self-aligning anti-friction and ball bearings. Mounted on the right hand end of this shaft is a swing clutch geared to the horizontal swing shaft. The right hand or boom hoist drum is solid-type design. The left hand drum is a split lagging design, either smooth or grooved. All drums are mounted on ball bearings. Refer to "lagging data" table for specifications.

HOIST BRAKES: Are external contracting friction band type, mechanically operated by pedals mounted on anti-friction bearings for maximum ease of operation. Hoist brakes have a foot-controlled lock.

CLUTCHES: All clutches are air actuated. All clutches are of the internal expanding friction band type with the exception of the swing clutches which are of the internal two shoe design.

BOOM HOIST: The boom hoist located on the rear drum shaft is of the spur gear and chain design with power up and power down control. Hoisting control is through an air actuated clutch with a spring set, air released holding brake. The brake automatically releases when hoisting or lowering. The lowering is controlled through an air actuated clutch mounted on the power lowering shaft and chain connected to the boom hoist drum. Lowering speed is reduced considerably resulting in a very smooth, precision, lowering operation. A ratchet and pawl device is supplied for added safety.

BOOMS AND JIBS: Extensible type with tubular chords — refer to boom and jib data.

BOOM STOP: Telescopic with or without automatic air cut-off of boom hoist clutch.

FAIRLEAD: Deck mounted, full revolving.

BOOM SUSPENSION: Crossover with 10 or 12 parts of line or 10 and 12 parts with mid-point suspension depending on boom length.

THIRD DRUM: One piece high capacity lagging running on ball bearings, located at left hand side of front drum shaft. Actuated by air operated clutch and brake. Refer to "lagging data" table for specifications.

FULL WIDTH FRONT DRUM: High capacity drum located on the front shaft, mounted on ball bearings and equipped with planetary controlled load lowering. Refer to "Lagging Data" table for specifications. (Third drum not available with this equipment.)

POWER LOWERING SHAFT: This shaft is located behind the rear hoist drum shaft and accommodates the power boom lowering and power load lowering.

POWER LOAD LOWERING: The power load lowering, air actuated clutch is chain connected to the left hand rear main hoist drum. The load lowering speed is reduced considerably, resulting in a very smooth precision, lowering operation.

COUNTERWEIGHT: One piece cast iron counterweight mounted at rear of rotating frame. Readily removable for weight reduction of machine for transporting.

COUNTERWEIGHT REMOVAL EQUIPMENT: Includes sheaves in base section of boom, lifting slings, and boom stop. Hoist cable over sheaves in boom base is used to load or unload counterweight from auxiliary truck. Gantry power up and down feature is used to position counterweight with slings provided.

GANTRY: The gantry consists of a basic low gantry to which is attached a high gantry having telescopic back legs with three set positions. Gantry can be (1) pinned in low position at cab height for traveling with boom in rest, (2) pinned in mid-position for traveling with boom suspended over rear of carrier, and (3), raised to full height for machine operation.

CONTROLS: All controls are air except hoist brakes which are mechanical.

OPERATOR'S CAB: Machine equipped with environmental operator's cab lined with sound barrier and deadening material, cuts noise level by an estimated 50 percent. Cab can be heated or air conditioned. Controls are grouped for maximum operator convenience, comfort and efficiency. Side and front windows slide up and down for ventilation. Numerous hatches and doors are provided for access to machinery and power plant. Hoist drums are not covered.

GEARING AND CHAIN DRIVES: All gearing, except rotating pinion and gear, is fully enclosed, running in oil with pump circulation for positive lubrication. The four chain sprockets for boom hoist and load lowering device require hand lubrication. Power take-off chain drive is fully enclosed, running in an oil bath.

REDUCTION GEAR FOR 2 SPEED OPERATION: This Cotta reduction gear unit will permit direct drive for normal machine speeds, plus a selective gear to obtain reduced machine speeds (approximately 50 to 60 percent) with no reduction in engine R.P.M. and power, for crane work.

MISCELLANEOUS ACCESSORIES: Ball and hook, hook block, electric signal horn, running board (short hook on type).

POWER TAKE-OFF: Disconnect clutch, precision roller chain.

**MAXIMUM LENGTH BOOM OR BOOM AND JIB COMBINATION THAT CAN BE HANDLED
HORIZONTALLY WITH OR WITHOUT BUMPER COUNTERWEIGHT AS INDICATED**

STANDARD JIB							
Over Rear With OR.		Over Side With OR.		Over Rear Less OR.		Over Side Less OR.	
L/B Cwt.	W/B Cwt.	L/B Cwt.	W/B Cwt.	L/B Cwt.	W/B Cwt.	L/B Cwt.	W/B Cwt.
180'	180'	180'	180'	150'	160'	140'	140'
170' + 20'	180' + 20'	160' + 20'	170' + 20'	120' + 20'	140' + 20'	110' + 20'	110' + 20'
170' + 30'	180' + 30'	160' + 30'	160' + 30'	120' + 30'	130' + 30'	110' + 30'	110' + 30'
160' + 40'	180' + 40'	150' + 40'	160' + 40'	110' + 40'	130' + 40'	100' + 40'	100' + 40'
HEAVY DUTY JIB							
Over Rear With OR.		Over Side With OR.		Over Rear Less OR.		Over Side Less OR.	
L/B Cwt.	W/B Cwt.	L/B Cwt.	W/B Cwt.	L/B Cwt.	W/B Cwt.	L/B Cwt.	W/B Cwt.
170' + 20'	180' + 20'	160' + 20'	160' + 20'	120' + 20'	130' + 20'	100' + 20'	100' + 20'
160' + 30'	180' + 30'	150' + 30'	160' + 30'	110' + 30'	130' + 30'	100' + 30'	100' + 30'
150' + 40'	170' + 40'	150' + 40'	150' + 40'	100' + 40'	120' + 40'	90' + 40'	100' + 40'
150' + 50'	160' + 50'	140' + 50'	150' + 50'	100' + 50'	110' + 50'	90' + 50'	80' + 60'
150' + 60'	160' + 60'	140' + 60'	140' + 60'	90' + 60'	110' + 60'	80' + 60'	80' + 60'

LB=Less Bumper Counterweight.
WB=With Bumper Counterweight.

BOOM AND JIB DATA

Boom, Tubular Pin Connected	
Type Service	Crane - Drag - Clamshell
Suspension	Cross Over and Pendants
Gantry	High Back Hitch (Telescoping Type)
Quan. Sheaves at Point Shaft	1 - 2 - 4
Convertibility	Cranes - Draglines - Clamshell
Dia. Point Sheaves	15 ³ / ₄ " P.D. - ³ / ₄ " Cable
Basic Boom Length	40'
Type Chords	2 ⁵ / ₈ " O.D. 100,000 P.S.I. Steel
Extensions	10', 20', 30' and 40' straight (51" x 56 ⁵ / ₈ " Sec.)
Max. Boom Length	Crane 180' Drag. & Clam. 60'.

Jib, Tubular Pin Connected	
Basic Length	20' (20" x 20" Sec.)
Max. Length	40'
Chord Size	1 ³ / ₄ " O.D.
Chord Material	40,000 #P.S.I. Yield
Quan. Sheaves at Point	One (1)
P.D. Point Sheave	15 ³ / ₄ " P.D. (³ / ₄ " Cable)
Capacity—20'-0"	8 Ton
30'-0"	5 Ton
40'-0"	3 ¹ / ₂ Ton

BOOM HOIST SUSPENSION DATA

*Boom Length	Reeving Required	Mid-Point Suspension Location
Up to 140'	10 or 12 Part Crossover	None
150' thru 160'	10 or 12 Part w/Mid-Point Suspension	80' From Boom Foot Pin
170' thru 180'	12 Part w/Mid-Point Suspension	90' From Boom Foot Pin

*Boom length determines suspension required. Jib does not affect requirement.

Time required to raise or lower a 40' boom from 20° above horizontal to 70° above horizontal with 10 part boom hoist reeving.	To Raise	To Lower
	45 Sec.	74 Sec.

CRANE WORKING RANGES

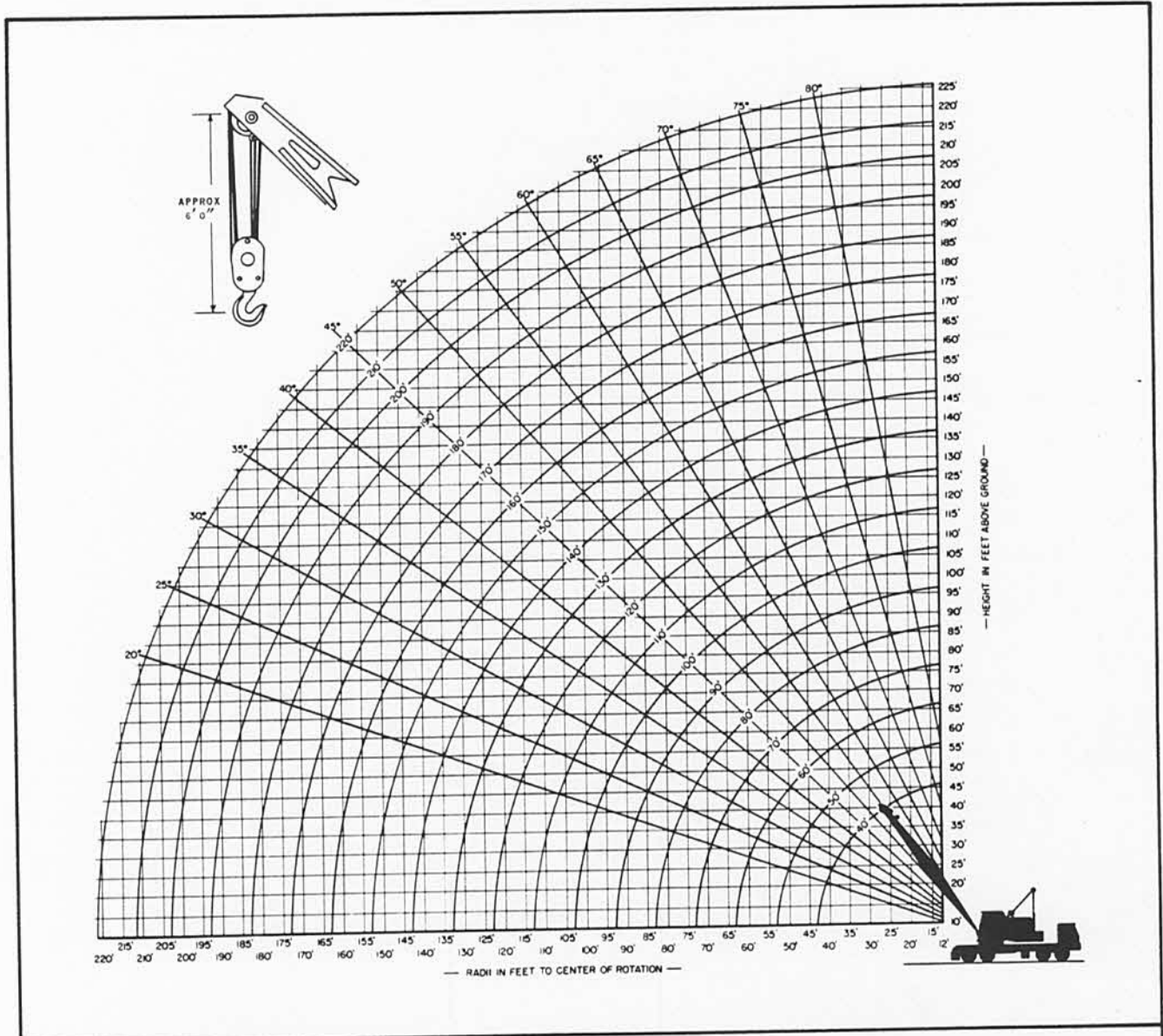

For Boom or Jib specifications, descriptions, maximum lengths and applications, refer to Boom and Jib Data chart.

Recommended Wire Rope Reeving For Hook Blocks	
Load in Pounds	No. Part Line
Over 14,500	2
Over 29,000	3
Over 43,500	4
Over 58,000	5
Over 72,500	6
Over 87,000	7
Over 101,500	8

Requires $\frac{3}{4}$ " dia. wire rope having a minimum breaking strength of 58,800 lbs.

Standard Jib (20" x 20" Sec.)			
Jib Length	Rating	Offset	Effective Weight
20'	8 Ton	5'-8"	1,900#
30'	5 Ton	10'-6"	2,300#
40'	3½ Ton	15'-1"	2,700#
Heavy Duty Jib (25½" x 34½" Sec.)			
Jib Length	Rating	Offset	Effective Weight
20'	13 Ton	6'-10"	2,250#
30'	10 Ton	12'-1"	2,750#
40'	7 Ton	17'-4"	3,250#
50'	5 Ton	22'-7"	3,700#
60'	4 Ton	27'-10"	4,300#

Jib Capacities are approximately the same as Boom Capacities at any given radius, but not to exceed the rating listed above. Effective Jib Weight to be subtracted from Boom Capacity Chart if load is raised on boom point when jib is assembled on boom.

