

34000 E A.S.C. PLUS

GOMMAGH

**SISTEMA QUALITÀ
AZIENDALE**

certificato in accordo alla norma
ISO 9001:2000 e sottoposto a
verifiche volontarie e periodiche



34000 E A.S.C. PLUS

GORMAGH



Radiocomandi di serie.
Radio remote control.
Radiocommande de série.
Funkfernsteuerung serienmäßig.
Radiomando de serie.



Comandi accessibili da terra. Tutti i carter in acciaio inox AISI 304.
Controls can be reached standing on the side. All the carters are in stainless steel AISI 304.
Commandes accessibles de terre. Tous les carter sont en acier inox AISI 304.
Von der Seite steuerbar. Schutzplatten in Edelstahl AISI 304.
Mandos desde el suelo. Todos los carters de acero inox AISI 304.

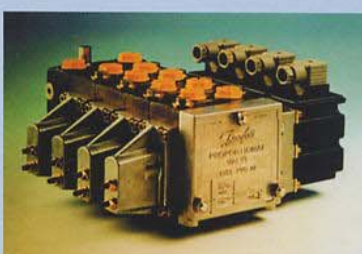

Distributore proporzionale DANFOSS.
DANFOSS proportional control bank.
Distributeur proportionnelle DANFOSS.
DANFOSS proportionale Steuerventil
Distribuidor proporcional DANFOSS.



Scambiatore di calore.
Heat exchanger.
Echangeur de chaleur.
Ölkühler.
Refrigerador de aceite.



Angolo negativo tra 1° e 2° braccio (20 gradi).
Negative angle between 1st and 2nd boom (20 degrees).
Angle négatif entre 1^{ère} et 2^{ème} bras (20 degrés).
Negativ Winkel zwischen ersten und zweiten Arm (20 Grad).
Angulo negativo entre 1° y 2° brazo (20 grados).



Sistema ritenzione cilindri grua chiusa.
Cylinders locking system when crane is folded.
Système de retenue vérin à grue fermée.
Halterung System mit zusammengelegten Kran.
Sistema de cierre cilindros con grua cerrada.



Verricello tiro diretto 2500 daN (OPZIONE).
2500 daN Winch on first line (OPTIONAL).
Trebail de tir direct 2500 daN (OPTION).
2500 daN Winde am ersten Seil (Auf Frage).
Cabrestante tiro directo 2500 daN (BAJO PEDIDO).



Tutti i cilindri a sfilo singolo. Con sfilo ad alta velocità (STANDARD). Con circuito FULL POWER, massima potenza (OPZIONE).
All the cylinders with single extension. High speed extension (STANDARD). With FULL POWER circuit, greatest power (OPTIONAL).
Tous les cylindres à extension individuel. Avec extension à vitesse élevée (STANDARD). Avec circuit FULL POWER, maximum puissance (OPTION).
Einzel Ausschulzylinder. Verlängerung mit Hochgeschwindigkeit (SERIENMÄSSIG). FULL POWER System für maximale Leistung (auf Frage).
Todos los cilindros con extension propia. Extension de alta velocidad (STANDARD). Circuito FULL POWER de máxima potencia (BAJO PEDIDO).

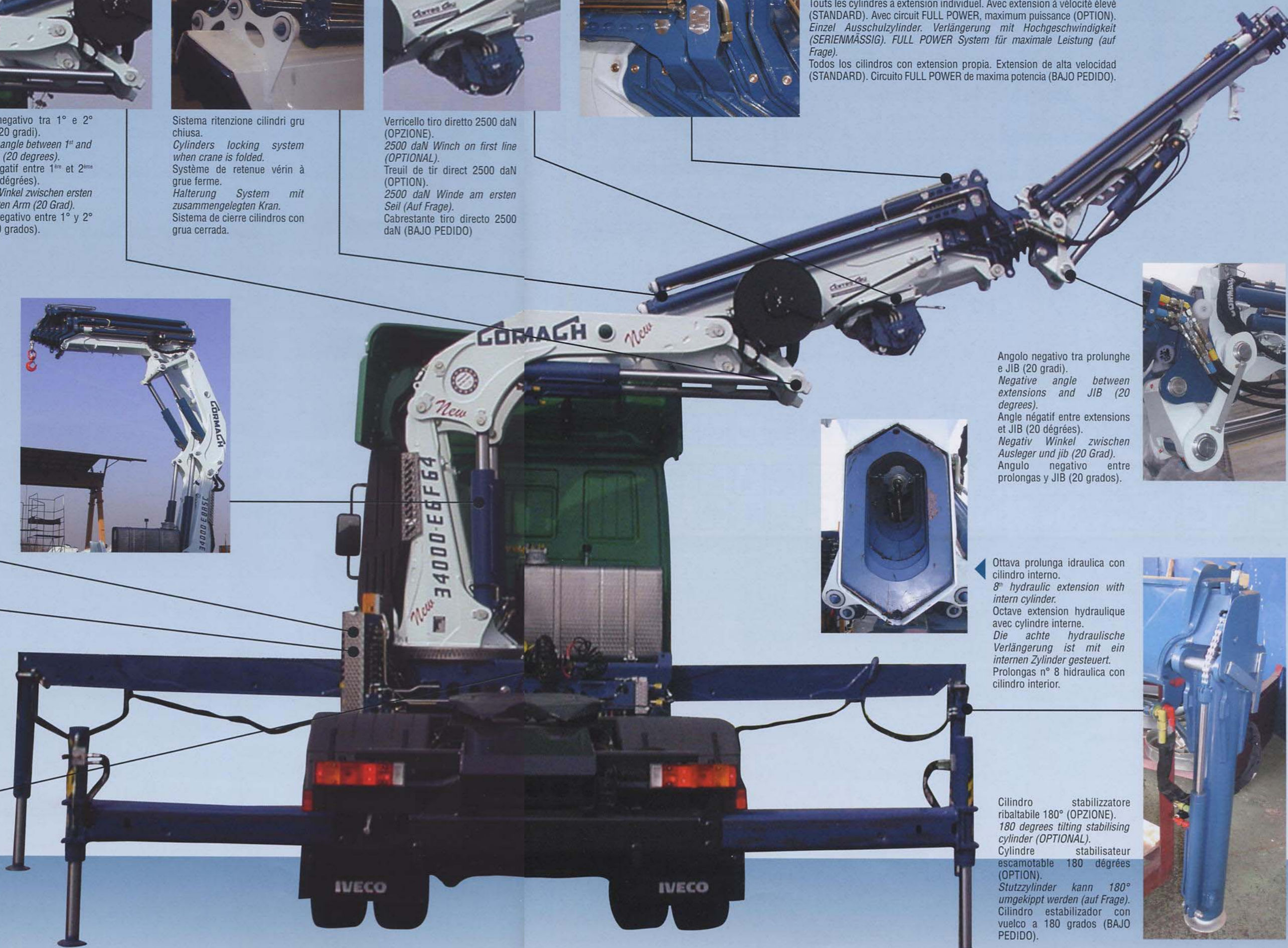

Angolo negativo tra prolunghe e JIB (20 gradi).
Negative angle between extensions and JIB (20 degrees).
Angle négatif entre extensions et JIB (20 degrés).
Negativ Winkel zwischen Ausleger und jib (20 Grad).
Angulo negativo entre prolongas y JIB (20 grados).

Ottava prolunga idraulica con cilindro interno.
8th hydraulic extension with intern cylinder.
Octave extension hydraulique avec cylindre interne.
Die achte hydraulische Verlängerung ist mit ein internen Zylinder gesteuert.
Prolongas n° 8 hidraulica con cilindro interior.

Cilindro stabilizzatore ribaltabile 180° (OPZIONE).
180 degrees tilting stabilising cylinder (OPTIONAL).
Cylindre stabilisateur escamotable 180 degrés (OPTION).
Stützylinder kann 180° umgekippt werden (auf Frage).
Cilindro estabilizador con vuelco a 180 grados (BAJO PEDIDO).



34000 E A.S.C. PLUS

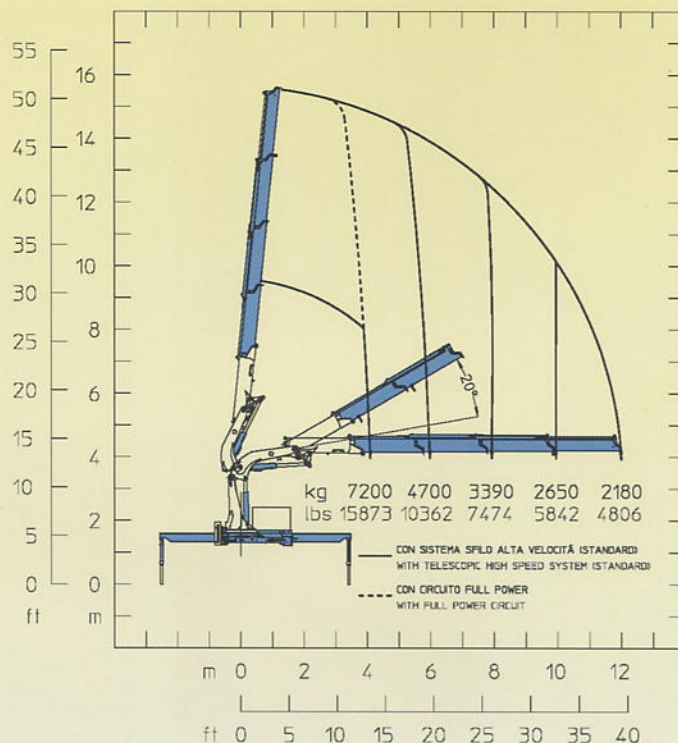
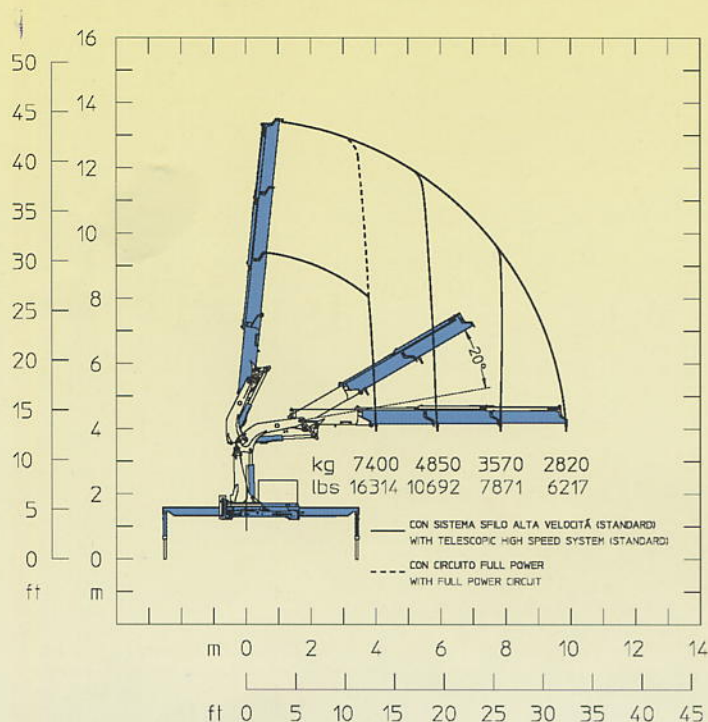

E3

E4

STANDARD



OPTIONAL



STANDARD



OPTIONAL



E3	E3		E4	E4
34500 da N*m	254460 Lb*ft	Momento statico massimo al perno torretta • Max. static moment at the turret pin Moment statique max. a l'axe de la tourelle • Max. statisches ubmoment am kranseulenbolzen	34500 da N*m	254460 Lb*ft
09.86 m	32' 4" ft	Sbraccio idraulico • Hydraulic boom length Longueur du bras hydraulique • Hydraulic reichweite	11.98 m	39' 4" ft
/	/	Sbraccio con prolunghe manuali • Bomm length with manual extensions Longueur du bras avec rallonges manuelles	/	/
3700 da N*m	27290 Lb*ft	Coppia di rotazione • Slew torque • Moment de rotation • Drehmoment	3700 da N*m	27290 Lb*ft
° - sec. 360 - 33	° - sec. 360 - 33	Tempo di rotazione • Slewing speed • Temp de rotation • Schwenkgeschwindigkeit	° - sec. 360 - 33	° - sec. 360 - 33
1500+1750 m	4' 11" + 5' 9" ft	Uscita stabilizzatori (*) • Outriggers extensions (*) Sortie des bequilles (*) • Breite der abstützung (*)	1500+1750 m	4' 11" + 5' 9" ft
5630 m	18' 6" ft	Larghezza stabilizzatori (**) • Outriggers width (**) Largeur des bequilles (**) • Breite der abstützung (**)	5630 m	18' 6" ft
1220 m	4' 0" ft	Lunghezza • Length • Longeur • Länge	1220 m	4' 0" ft
2550 m	8' 4" ft	Larghezza • Width • Largeur • Breite	2550 m	8' 4" ft
2250 m	7' 5" ft	Altezza • Height • Hauteur • Höhe	2250 m	7' 5" ft
3530 Kg	7782 lbs	Peso (senza olio e montaggio) • Weight (without oil and fitting) Poids (sans huile et montage) • Gewicht (ohne öl und ohne)	3720 Kg	8201 lbs
60 l. min	16 us gal min	Portata pompa (***) • Pump delivery (***) • Capacité de la pompe (***) • Pumpenheistung (***)	60 l. min	16 us gal min
280 bar	4061 psi	Pressione • Pressure • Pression • Druck	280 bar	4061 psi
160 l	42 Us gal	Capacità serbatoio olio • Oil tank capacity • Capacité de reservoir d'huile • Öl tank inhalt	160 l	42 Us gal

Opzione • Option • Option • Option: (*) 2100 + 2350 (6' 11" + 7' 9") - (**) 6830 (22' 5") - (***) 80 (21)

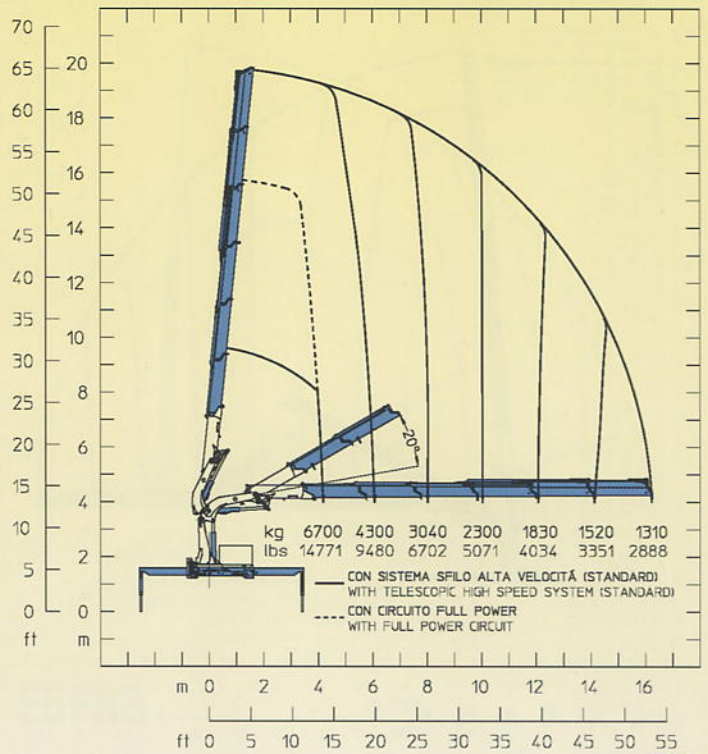
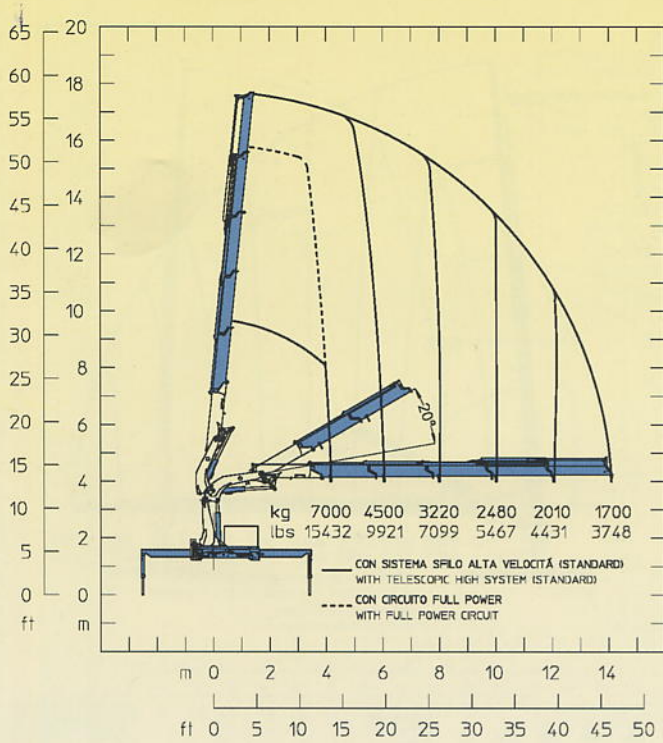

E5

E6

STANDARD



OPTIONAL



STANDARD



OPTIONAL



E5	E5		E6	E6
34500 da N*m	254460 Lb*ft	Momento statico massimo al perno torretta • Max. static moment at the turret pin Moment statique max. a l'axe de la tourelle • Max. statisches ubmoment am kransaulenbolzen	34500 da N*m	254460 Lb*ft
14.09 m	46' 3" ft	Sbraccio idraulico • Hydraulic boom length Longueur du bras hydraulique • Hydraulic reichweite	16.23 m	53' 3" ft
/	/	Sbraccio con prolunghe manuali • Boom length with manual extensions Longueur du bras avec rallonges manuelles	/	/
3700 da N*m	27290 Lb*ft	Coppia di rotazione • Slew torque • Moment de rotation • Drehmoment	3700 da N*m	27290 Lb*ft
° - sec. 360 - 33	° - sec. 360 - 33	Tempo di rotazione • Slewing speed • Temp de rotation • Schwenkgeschwindigkeit	° - sec. 360 - 33	° - sec. 360 - 33
1500+1750 m	4' 11" + 5' 9" ft	Uscita stabilizzatori (*) • Outriggers extensions (*) Sortie des bequilles (*) • Breite der abstützung (*)	1500+1750 m	4' 11" + 5' 9" ft
5630 m	18' 6" ft	Larghezza stabilizzatori (**) • Outriggers width (**) Largeur des bequilles (**) • Breite der abstützung (**)	5630 m	18' 6" ft
1220 m	4' 0" ft	Lunghezza • Length • Longeur • Länge	1220 m	4' 0" ft
2550 m	8' 4" ft	Larghezza • Width • Largeur • Breite	2550 m	8' 4" ft
2250 m	7' 5" ft	Altezza • Height • Huteur • Höhe	2250 m	7' 5" ft
3890 Kg	8576 lbs	Peso (senza olio e montaggio) • Weight (without oil and fitting) Poids (sans huile et montage) • Gewicht (ohne öl und ohne)	4070 Kg	8973 lbs
60 l. min	16 us gal min	Portata pompa (***) • Pump delivery (***) • Capacité de la pompe (***) • Pumpenleistung (***)	60 l. min	16 us gal min
280 bar	4061 psi	Pressione • Pressure • Pression • Druck	280 bar	4061 psi
160 l	42 Us gal	Capacità serbatoio olio • Oil tank capacity • Capacité de reservoir d'huile • Öl tank inhalt	160 l	42 Us gal

Opzione • Option • Option • Option: (*) 2100 + 2350 (6' 11" + 7' 9") - (**) 6830 (22' 5") - (***) 80 (21)

34000 E A.S.C. PLUS

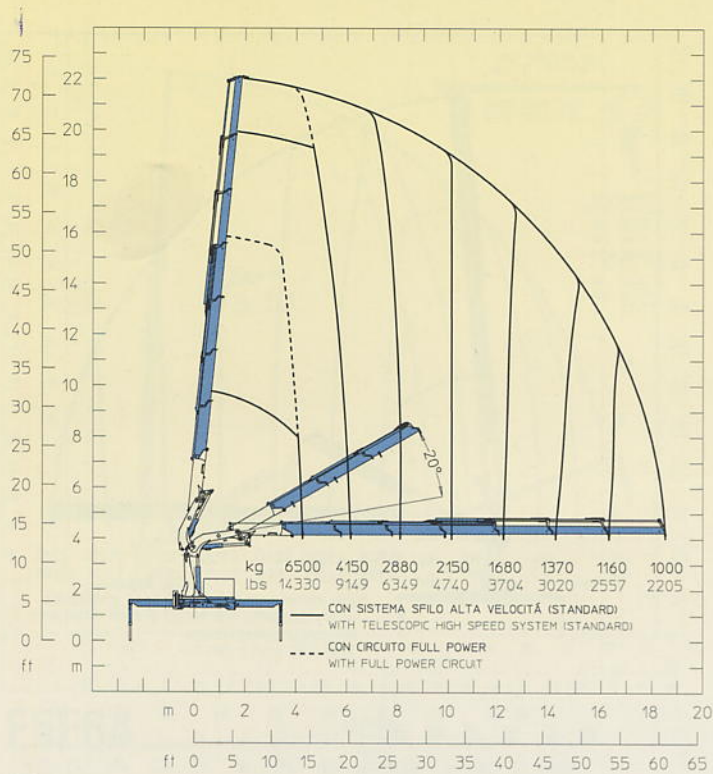

E7

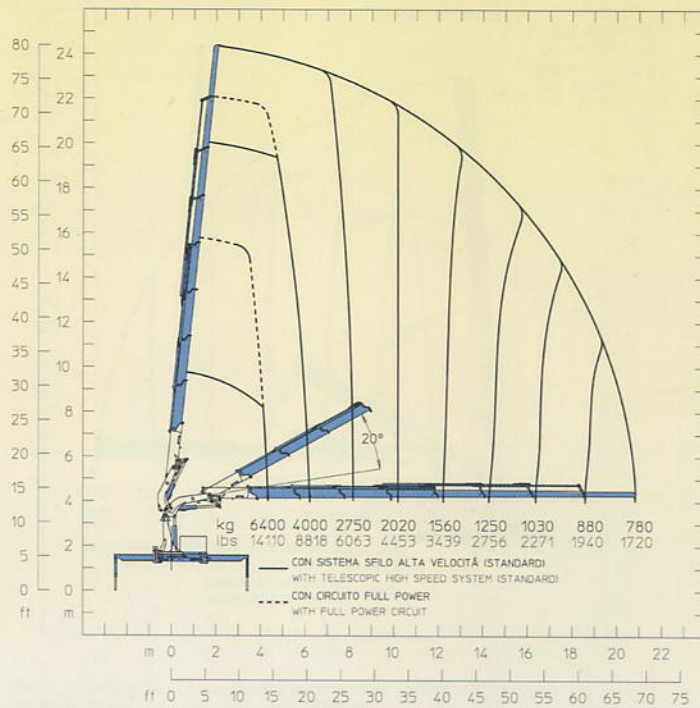

E8

STANDARD



OPTIONAL



STANDARD



OPTIONAL



E7	E7		E8	E8
34500 da N*m	254460 Lb*ft	Momento statico massimo al perno torretta • Max. static moment at the turret pin Moment statique max. a l'axe de la tourelle • Max. statisches ubmoment am kranstaulenbolzen	34500 da N*m	254460 Lb*ft
18.52 m	60' 9" ft	Sbraccio idraulico • Hydraulic boom length Longueur du bras hydraulique • Hydraulic reichweite	20.81 m	68' 3" ft
/	/	Sbraccio con prolunghe manuali • Bomm length with manual extensions Longueur du bras avec rallonges manuelles	/	/
3700 da N*m	27290 Lb*ft	Coppia di rotazione • Slew torque • Moment de rotation • Drehmoment	3700 da N*m	27290 Lb*ft
° - sec. 360 - 33	° - sec. 360 - 33	Tempo di rotazione • Slewing speed • Temp de rotation • Schwenkgeschwindigkeit	° - sec. 360 - 33	° - sec. 360 - 33
1500+1750 m	4' 11" + 5' 9" ft	Uscita stabilizzatori (*) • Outriggers extensions (*) Sortie des bequilles (*) • Breite der abstützung (*)	1500+1750 m	4' 11" + 5' 9" ft
5630 m	18' 6" ft	Larghezza stabilizzatori (**) • Outriggers width (**) Largeur des bequilles (**) • Breite der abstützung (**)	5630 m	18' 6" ft
1220 m	4' 0" ft	Lunghezza • Length • Longueur • Länge	1220 m	4' 0" ft
2550 m	8' 4" ft	Larghezza • Width • Largeur • Breite	2550 m	8' 4" ft
2250 m	7' 5" ft	Altezza • Height • Huteur • Höhe	2250 m	7' 5" ft
4240 Kg	9384 lbs	Peso (senza olio e montaggio) • Weight (without oil and fitting) Poids (sans huile et montage) • Gewicht (ohne öl und ohne)	4370 Kg	9634 lbs
60 l. min	16 us gal min	Portata pompa (***) • Pump delivery (***) • Capacité de la pompe (***) • Pumpenleistung (***)	60 l. min	16 us gal min
280 bar	4061 psi	Pressione • Pressure • Pression • Druck	280 bar	4061 psi
160 l	42 Us gal	Capacità serbatoio olio • Oil tank capacity • Capacité de reservoir d'huile • Öl tank inhalt	160 l	42 Us gal

Opzione • Option • Option • Option: (*) 2100 + 2350 (6' 11" + 7' 9") - (**) 6830 (22' 5") - (***) 80 (21)

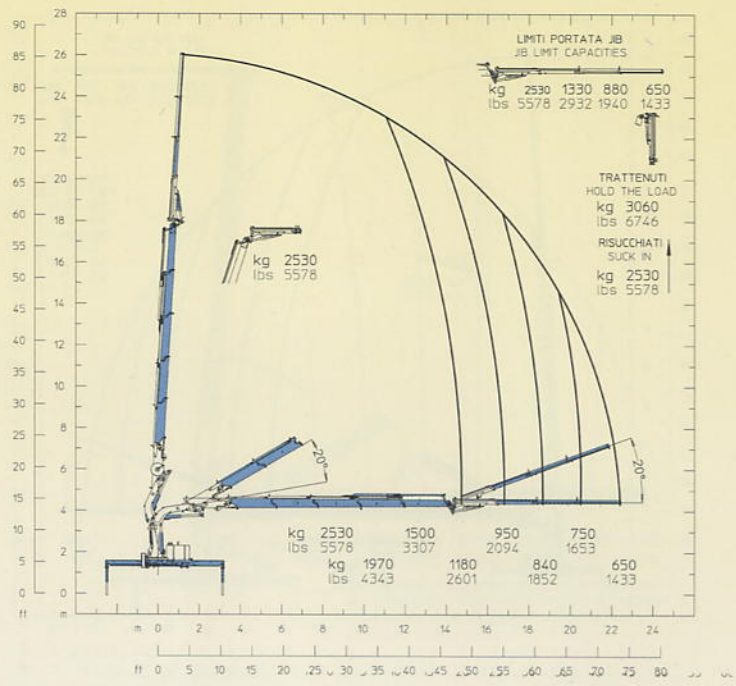
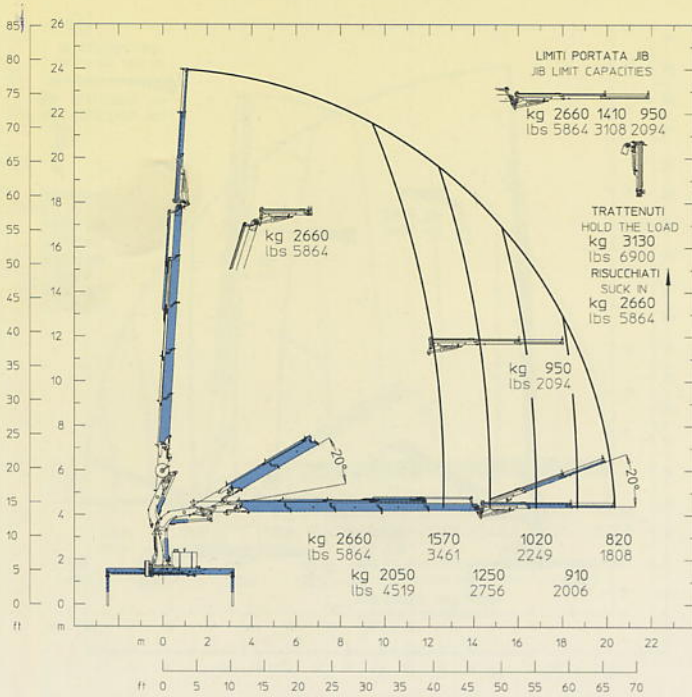

E5F62

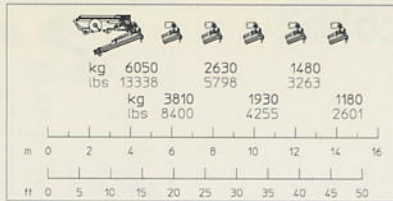

E5F63

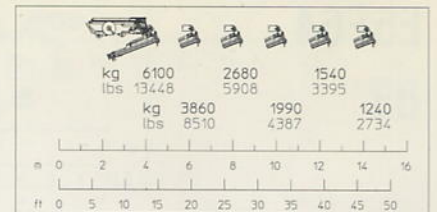

STANDARD



OPTIONAL



STANDARD



OPTIONAL



E5F62	E5F62		E5F63	E5F63
34500 da N*m	254460 Lb*ft	Momento statico massimo al perno torretta • Max. static moment at the turret pin Moment statique max. a l'axe de la tourelle • Max. statisches ubmoment am kranraubenbolzen	34500 da N*m	254460 Lb*ft
20.33 m	66' 8" ft	Sbraccio idraulico • Hydraulic boom length Longueur du bras hydraulique • Hydraulic reichweite	22.39 m	73' 5" ft
/	/	Sbraccio con prolunghe manuali • Boom length with manual extensions Longueur du bras avec rallonges manuelles	/	/
3700 da N*m	27290 Lb*ft	Coppia di rotazione • Slew torque • Moment de rotation • Drehmoment	3700 da N*m	27290 Lb*ft
° - sec. 360 - 33	° - sec. 360 - 33	Tempo di rotazione • Slewing speed • Temp de rotation • Schwenkgeschwindigkeit	° - sec. 360 - 33	° - sec. 360 - 33
1500+1750 m	4' 11" + 5' 9" ft	Uscita stabilizzatori (*) • Outriggers extensions (*) Sortie des bequilles (*) • Breite der abstützung (*)	1500+1750 m	4' 11" + 5' 9" ft
5630 m	18' 6" ft	Larghezza stabilizzatori (**) • Outriggers width (**) Largeur des bequilles (**) • Breite der abstützung (**)	5630 m	18' 6" ft
1220 m	4' 0" ft	Lunghezza • Length • Longueur • Länge	1220 m	4' 0" ft
2550 m	8' 4" ft	Larghezza • Width • Largeur • Breite	2550 m	8' 4" ft
2510 m	8' 3" ft	Altezza • Height • Huteur • Höhe	2510 m	8' 3" ft
4610 Kg	10163 lbs	Peso (senza olio e montaggio) • Weight (without oil and fitting) Poids (sans huile et montage) • Gewicht (ohne öl und ohne)	4680 Kg	10318 lbs
60 l. min	16 us gal min	Portata pompa (***) • Pump delivery (***) • Capacité de la pompe (***) • Pumpenleistung (***)	60 l. min	16 us gal min
280 bar	4061 psi	Pressione • Pressure • Pression • Druck	280 bar	4061 psi
160 l	42 Us gal	Capacità serbatoio olio • Oil tank capacity • Capacité de reservoir d'huile • Öl tank inhalt	160 l	42 Us gal

34000 E A.S.C. PLUS

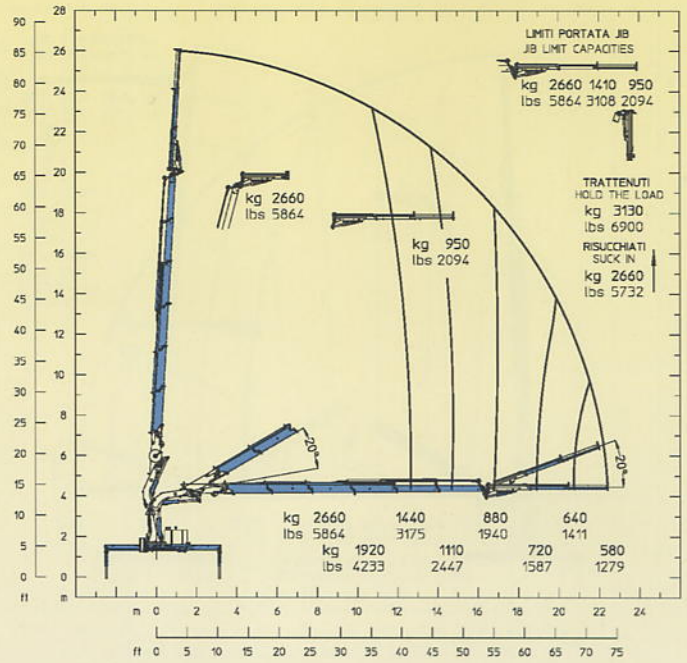
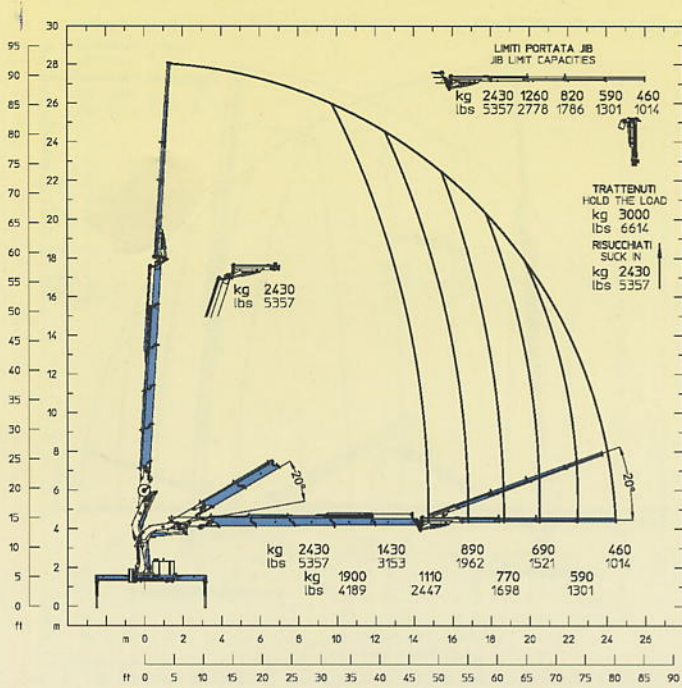

E5F64

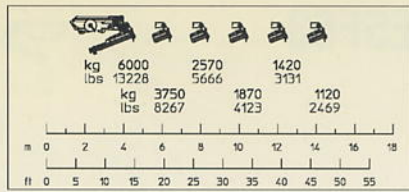

E6F62

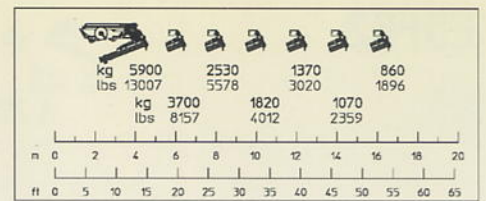

STANDARD



OPTIONAL



STANDARD



OPTIONAL

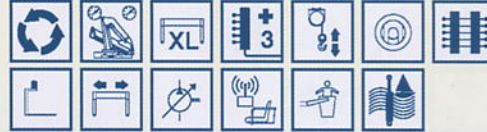

E5F64	E5F64		E6F62	E6F62
34500 da N*m	254460 Lb*ft	Momento statico massimo al perno torretta • Max. static moment at the turret pin Moment statique max. a l'axe de la tourelle • Max. statisches ubmoment am kranstrahlenbolzen	34500 da N*m	254460 Lb*ft
24.45 m	80' 3" ft	Sbraccio idraulico • Hydraulic boom length Longueur du bras hydraulique • Hydraulic reichweite	22.43 m	73' 7" ft
/	/	Sbraccio con prolunghe manuali • Boom length with manual extensions Longueur du bras avec rallonges manuelles	/	/
3700 da N*m	27290 Lb*ft	Coppia di rotazione • Slew torque • Moment de rotation • Drehmoment	3700 da N*m	27290 Lb*ft
° - sec. 360 - 33	° - sec. 360 - 33	Tempo di rotazione • Slewing speed • Temp de rotation • Schwenkgeschwindigkeit	° - sec. 360 - 33	° - sec. 360 - 33
1500+1750 m	4' 11" + 5' 9" ft	Uscita stabilizzatori (*) • Outriggers extensions (*) Sortie des bequilles (*) • Breite der abstützung (*)	1500+1750 m	4' 11" + 5' 9" ft
5630 m	18' 6" ft	Larghezza stabilizzatori (**) • Outriggers width (**) Largeur des bequilles (**) • Breite der abstützung (**)	5630 m	18' 6" ft
1220 m	4' 0" ft	Lunghezza • Length • Longueur • Länge	1220 m	4' 0" ft
2550 m	8' 4" ft	Larghezza • Width • Largeur • Breite	2550 m	8' 4" ft
2510 m	8' 3" ft	Altezza • Height • Huteur • Höhe	2510 m	8' 3" ft
4740 Kg	10450 lbs	Peso (senza olio e montaggio) • Weight (without oil and fitting) Poids (sans huile et montage) • Gewicht (ohne öl und ohne)	4790 Kg	10560 lbs
60 l. min	16 us gal min	Portata pompa (***) • Pump delivery (***) • Capacité de la pompe (***) • Pumpenleistung (***)	60 l. min	16 us gal min
280 bar	4061 psi	Pressione • Pressure • Pression • Druck	280 bar	4061 psi
160 l	42 Us gal	Capacità serbatoio olio • Oil tank capacity • Capacité de reservoir d'huile • Öl tank inhalt	160 l	42 Us gal

Opzione • Option • Option • Option: (*) 2100 + 2350 (6' 11" + 7' 9") - (**) 6830 (22' 5") - (***) 80 (21)

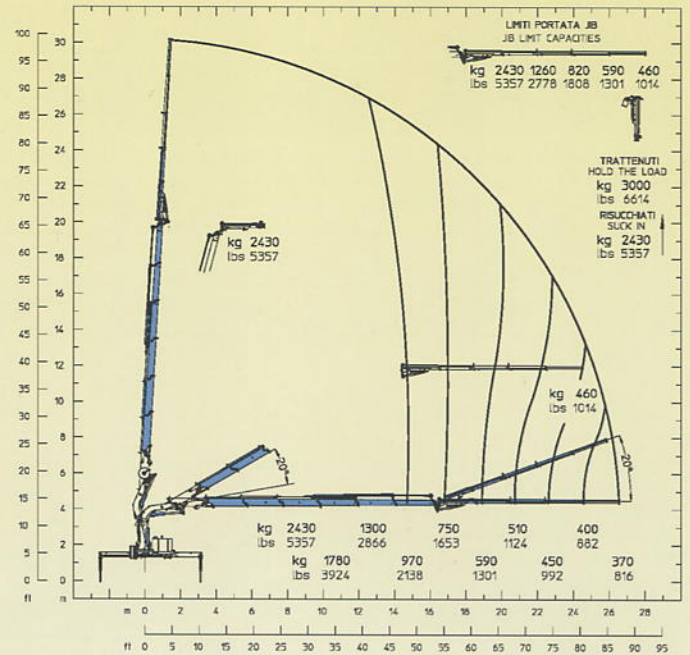
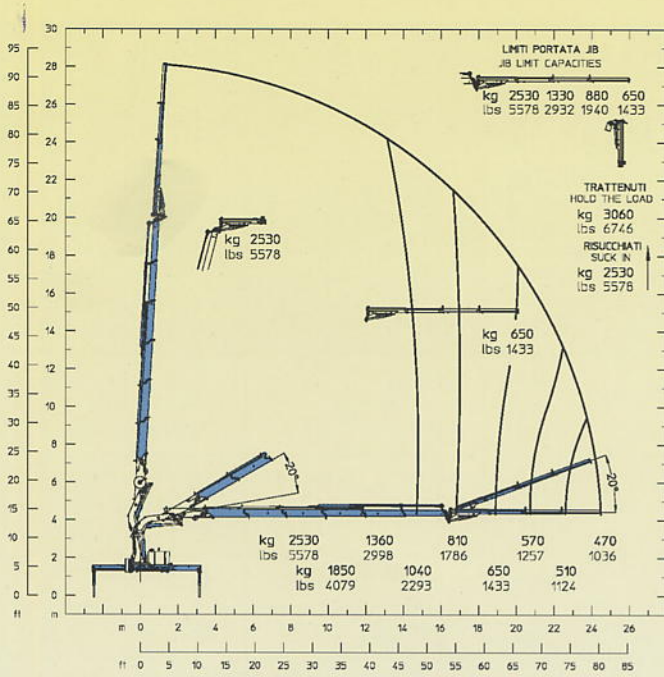

E6F63

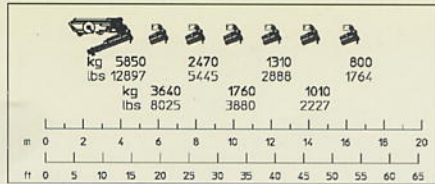

E6F64

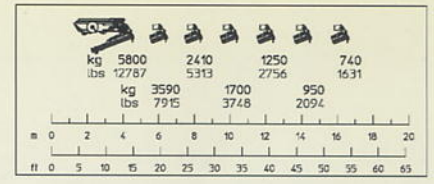

STANDARD



OPTIONAL



STANDARD



OPTIONAL



E6F63	E6F63		E6F64	E6F64
34500 da N*m	254460 Lb*ft	Momento statico massimo al perno torretta • Max. static moment at the turret pin	34500 da N*m	254460 Lb*ft
24.49 m	80' 4" ft	Moment statique max. a l'axe de la tourelle • Max. statisches ubmoment am kranstrahlenbolzen	26.55 m	87' 1" ft
/	/	Sbraccio idraulico • Hydraulic boom length	/	/
/	/	Longueur du bras hydraulique • Hydraulic reichweite	/	/
3700 da N*m	27290 Lb*ft	Sbraccio con prolunghe manuali • Bomm length with manual extensions	3700 da N*m	27290 Lb*ft
° - sec. 360 - 33	° - sec. 360 - 33	Longueur du bras avec rallonges manuelles	° - sec. 360 - 33	° - sec. 360 - 33
1500+1750 m	4' 11" + 5' 9" ft	Coppia di rotazione • Slew torque • Moment de rotation • Drehmoment	1500+1750 m	4' 11" + 5' 9" ft
5630 m	18' 6" ft	Tempo di rotazione • Slewing speed • Temp de rotation • Schwenkgeschwindigkeit	5630 m	18' 6" ft
1220 m	4' 0" ft	Uscita stabilizzatori (*) • Outriggers extensions (*)	1220 m	4' 0" ft
2550 m	8' 4" ft	Sortie des bequilles (*) • Breite der abstützung (*)	2550 m	8' 4" ft
2510 m	8' 3" ft	Larghezza stabilizzatori (**) • Outriggers width (**)	2510 m	8' 3" ft
4860 Kg	10714 lbs	Largueur des bequilles (***) • Breite der abstützung (***)	4920 Kg	10847 lbs
60 l. min	16 us gal min	Lunghezza • Length • Longueur • Länge	60 l. min	16 us gal min
280 bar	4061 psi	Larghezza • Width • Largeur • Breite	280 bar	4061 psi
160 l	42 Us gal	Altezza • Height • Hauteur • Höhe	160 l	42 Us gal
		Peso (senza olio e montaggio) • Weight (without oil and fitting)		
		Poids (sans huile et montage) • Gewicht (ohne öl und ohne)		
		Portata pompa (****) • Pump delivery (****) • Capacité de la pompe (****) • Pumpenleistung (****)		
		Pressione • Pressure • Pression • Druck		
		Capacità serbatoio olio • Oil tank capacity • Capacité de reservoir d'huile • Öl tank inhalt		

Opzione • Option • Option • Option: (*) 2100 + 2350 (6' 11" + 7' 9") - (**) 6830 (22' 5") - (****) 80 (21)

34000 E A.S.C. PLUS



E3		E4		E5		E6		E7		E8		E5F62		E5F63		E5F64		E6F62		E6F63		E6F64	
m	kg	m	kg	m	kg	m	kg	m	kg	m	kg	m	kg	m	kg	m	kg	m	kg	m	kg	m	kg
ft	lbs	ft	lbs	ft	lbs	ft	lbs	ft	lbs	ft	lbs	ft	lbs	ft	lbs	ft	lbs	ft	lbs	ft	lbs	ft	lbs
4.00	7400	4.08	7200	4.15	7000	4.19	6700	4.27	6500	4.32	6400	8.60	2660	8.68	2530	8.76	2430	8.60	2660	8.68	2530	8.76	2430
13' 1"	16314	13' 5"	15873	13' 7"	15432	13' 9"	14771	14' 0"	14330	14' 2"	14110	28' 3"	5864	28' 6"	5578	28' 9"	5357	28' 3"	5864	28' 6"	5578	28' 9"	5357
5.89	4850	5.97	4700	6.03	4500	6.07	4300	6.15	4150	6.21	4000	10.55	2050	10.63	1970	10.71	1900	10.55	1920	10.63	1850	10.71	1780
19' 4"	10692	19' 7"	10362	19' 9"	9921	19' 11"	9480	20' 2"	9149	20' 4"	8818	34' 7"	4519	34' 11"	4343	35' 2"	4189	34' 7"	4233	34' 11"	4079	35' 2"	3924
7.84	3570	7.92	3390	7.98	3220	8.02	3040	8.10	2880	8.16	2750	12.57	1570	12.65	1500	12.73	1430	12.57	1440	12.65	1360	12.73	1300
25' 9"	7871	25' 12"	7474	26' 2"	7099	26' 4"	6702	26' 7"	6349	26' 9"	6063	41' 3"	3461	41' 6"	3307	41' 9"	3153	41' 3"	3175	41' 6"	2998	41' 9"	2866
9.86	2820	9.94	2650	10.00	2480	10.04	2300	10.12	2150	10.18	2020	14.61	1250	14.69	1180	14.77	1110	14.61	1110	14.69	1040	14.77	970
32' 4"	6217	32' 7"	5842	32' 10"	5467	32' 11"	5071	33' 2"	4740	33' 5"	4453	47' 11"	2756	48' 2"	2601	48' 5"	2447	47' 11"	2447	48' 2"	2293	48' 5"	2138
		11.98	2180	12.04	2010	12.08	1830	12.16	1680	12.22	1560	16.75	1020	16.73	950	16.82	890	16.66	880	16.74	810	16.82	750
		39' 4"	4806	39' 6"	4431	39' 8"	4034	39' 11"	3704	40' 1"	3439	54' 11"	2249	54' 11"	2094	55' 2"	1962	54' 8"	1940	54' 11"	1786	55' 2"	1653
				14.09	1700	14.13	1520	14.21	1370	14.27	1250	18.50	910	18.58	840	18.66	770	18.86	720	18.84	650	18.92	590
				46' 3"	3748	46' 4"	3351	46' 7"	3020	46' 10"	2756	60' 8"	2006	60' 11"	1852	61' 3"	1698	61' 11"	1587	61' 10"	1433	62' 1"	1301
						16.23	1310	16.31	1160	16.37	1030	20.33	820	20.41	750	20.49	690	20.59	640	20.67	570	20.75	510
						53' 3"	2888	53' 6"	2557	53' 8"	2271	66' 8"	1808	66' 12"	1653	67' 3"	1521	67' 7"	1411	67' 10"	1257	68' 1"	1124
								18.52	1000	18.58	880			22.39	650	22.47	590	22.43	580	22.51	510	22.59	450
								60' 9"	2205	60' 11"	1940			73' 5"	1433	73' 9"	1301	73' 7"	1279	73' 10"	1124	74' 1"	992
										20.81	780					24.45	460			24.49	470	24.57	400
										68' 3"	1720					80' 3"	1014			80' 4"	1036	80' 7"	882
																						26.55	370
																						87' 1"	816

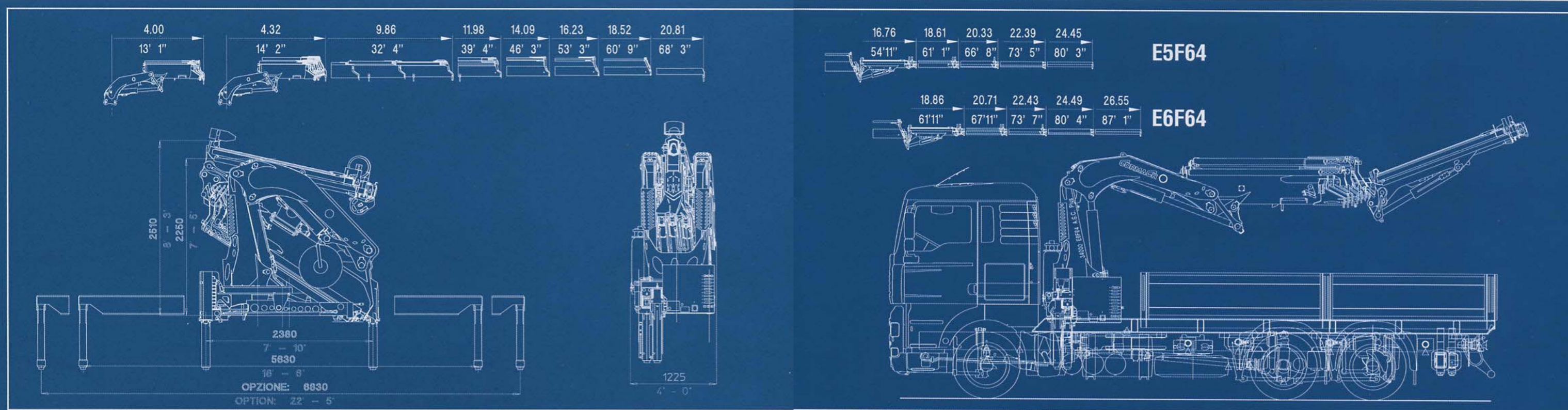

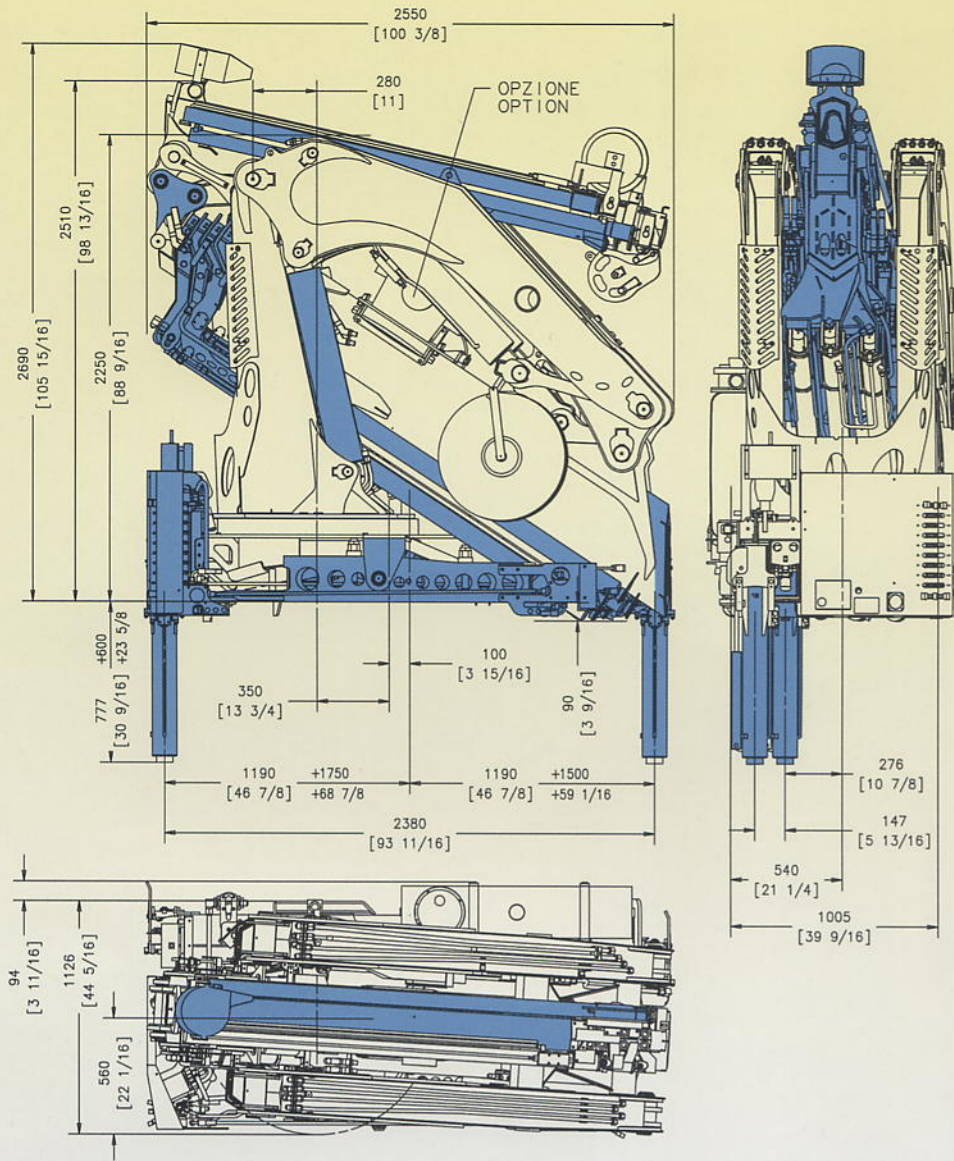

Radiocontrollo
Radio remote control
Radiocommandes
Funkfernsteuerung
Radiomando



Distributore proporzionale DANFOSS
DANFOSS flow and pressure compensated control valve
Distributeur proportional DANFOSS
DANFOSS proportional Steuerventil
Distribudor proporsional DANFOSS



Rotazione 180° o 400°
Rotation: 180° or 400°
Rotation: 180° o 400°
Drehung: 180° oder 400°
Rotation: 180° o 400°



Limitatore di momento
Load limiting device
Limiteur de charge
Über lastabschal tungssystem
Limitador de carga



Stabilizzatori gru base girevoli
Tilt up outriggers
Bequilles tournants
Drehbare stützen
Estabilizadores giratorios de la gru base



Stabilizzatori gru base estendibili idraulicamente
Outriggers with hydraulic extension
Stabilisateurs avec extension hydraulique
Hydraulisch ausfahrbare stützen
Estabilizadores grua de base desplegabes hidraulicamente



Comando supplementare non attivato
Additional free section not activated
Section du distributeur pas activée
Zusätzlicher steuerschieber
Mando auxiliar no activado



Rotazione continua
Continuous rotation
Rotation continue
Endlos schwenkwerk
Rotacion continua



Doppio limitatore di momento
Double load limiting device
Double limiteur de charge
Doppel Überlastabschal tungssystem
Doble limitador de carga



Stabilizzatori gru base extralarghi
Extra wide crane outriggers
Stabilisateurs grue extra large
Extra breite Kran Stützen
Estabilizadores de gran anclura



Comando supplementare attivato
Additional function
Section de distributeur activee
Zusatzfunktion
Mando auxiliar activado



Verricello
Winch
Treuil
Seilwinde
Cabrestante



Piastre maggiorate
Large ground plates
Plaques stabilisateurs
Bodenplatten
Placas estabilizadoras de suelo de gran lamana



Comandi bilaterali
Dual controls stations
Commandes a gauche et a droite
Beidseitige bedienung
Mandos bilaterales



Utilizzo con attrezzo
Additional accessoires
Utilisation avec accessoire
Zubehor
Accesorios auxiliares



Traversa usiliaria estendibile
Additional outriggers with lateral extension
Stabilisateurs supplementaires avec enlargementment
Ausfahrbare zusatz-stutzen
Estabilizadores adicionales con extension lateral



Pompa a portata variabile
Pump with load sensing
Pompe à debit variable
Verstellpumpe load sensing
Bomba de caudal variable



Posto manovra alto solo con radiocomando
Control valve on the turret to be controlled with radio remote control only
Distributeur sur colonne avec control radio soul mente
Das an der Säule angebautes Steuerventil kann nur durch Funk fernsteuerung bedient werden.
El distribudor puede eser controlado solo con un mando a distancia



Cestello
Basket
Nacelle
Personenkorb
Cesta



Trattamento marino della gru
Marine treatment of the crane
Traitement marine de la grue
Marine behandlung des kranes
Tratamiento especial marino de la grua



GORMAGH

New



34000-E6F64

New

CENTRO GRU

New



CORMACH

Cormach s.r.l. - Via Madonnina, 27 - C.P. 199 - 25018 MONTICHIARI (BS) - ITALY
Tel. 0039.030.9656811 - Telefax 0039.030.9656846.7.8
E-mail: info@cormach.com - Web: <http://www.cormach.com>

A fronte di una continua ricerca tecnologica i dati possono cambiare senza preavviso. Contattare il nostro Ufficio Commerciale per ulteriori informazioni.
Because of continuous technology research data can change without notice. Please, contact our Commercial Dept. for further information.
A cause de une continue recherche technologique les données peuvent changer sans préavis. Contacter notre Bureau Commercial pour des autres informations.
Irrtum und technische Änderung vorbehalten masse und gewichte unverbindlich. Unser Vertriebs erreit Ihnen gerne weitere Auskünfte. Bitte rufen Sie uns an.
Debito a los continuos avances tecnológicos los datos pueden variar sin notificación previa. Para más información rogamos contacten nuestro Departamento Comercial.