

**NATIONAL
SERIES 200
PROPOSAL**

Date: _____

Prepared for: _____

Submitted by: _____

(Firm Name) _____

(Address) _____

(City & State) _____

(Zip) _____

(Phone) _____

Signed: _____



NATIONAL CRANE

Subsidiary of Kidde, Inc.
KIDDE

National reserves the right to change designs, prices, and specifications at any time without notice.

Printed in U.S.A. Form No. S200108412M

© 1984 National Crane

Description:

- 1. Series _____ \$ _____
- 2. Boom _____ \$ _____
- 3. Jib _____ \$ _____
- 4. Line Block 2 Part \$ _____

Attachments:

- 5. _____ \$ _____
- 6. _____ \$ _____
- 7. _____ \$ _____

Mounting:

- 8. Installation Std. Spec _____ \$ _____
- 9. Frame reinforcing Weld Bolt-Extra _____ \$ _____
- 10. Platform body _____ Ft. Wood Steel _____ \$ _____
- 11. Weight in bed _____ lbs (if required) _____ \$ _____
- 12. Boom rest Parallel Low _____ \$ _____
- 13. Chassis _____ \$ _____
- 14. Rear Bumper _____ \$ _____
- 15. Freight _____ \$ _____

This quotation will remain firm for _____ Days.

Accepted by: _____ \$ _____
(Name) Total Price

(Firm Name) Date

General Offices
11200 North 148th Street/Waverly, NE 68462/402/786-2240

Service Center
701 N.W. 27th Street/Lincoln, NE 68528/402/474-2666

Your National Dealer

NATIONAL SERIES 200

Truck-mounted telescoping cranes and accessories
Maximum height: 48 feet/14.6 meters
Maximum capacity: 10,700 pounds/4.9 metric tons

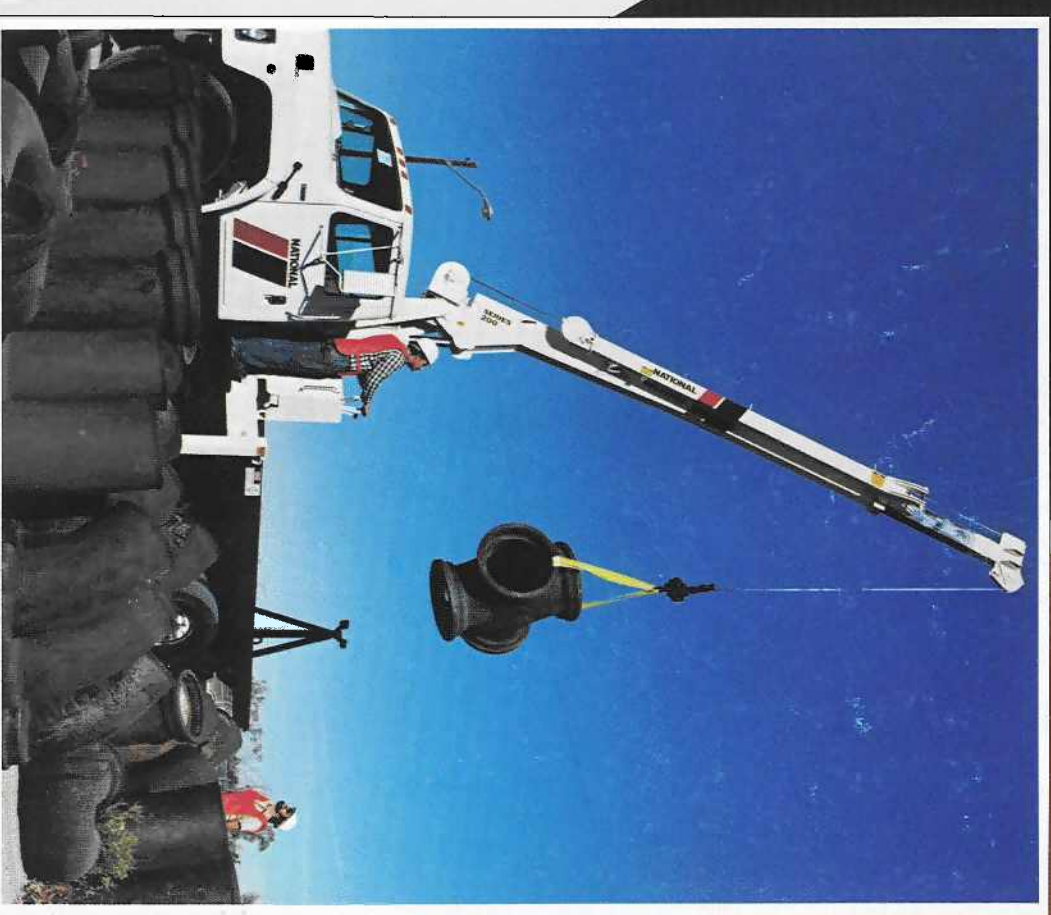

**AMERICA'S
TRUCK-MOUNTED
HYDRAULIC CRANE LEADER**

NATIONAL SERIES 200

National is America's leading manufacturer of commercial truck-mounted telescoping and articulating cranes. We build cranes for a wide range of jobs. And nobody builds them better. Nationals are tough, durable, and dependable—the sensible answer to your everyday lifting requirements.

With a National, you are assured of a well-engineered, well-manufactured, and fully tested machine designed for your applications. At National we put quality first. Our commitment to product quality is our pledge to provide our customers with reliable products designed to provide years of service.

National's Series 200 telescoping crane gives you what you want and need in a tough, compact crane. Consider these Series 200 facts and features:

- 10,700-pound (4.9MT) rated capacity
- Reaches up to 48 feet (14.6m) high
- Box-section boom construction provides extra strength and lower boom weight
- Boom corner seams are ultrasonically tested for proper weld penetration
- Dual controls in SAE recommended orientation
- Control stations positioned at platform level for greater visibility and easier operation
- Compact mounting leaves more room for payloads
- Wide, fully hydraulic outriggers with extra-large pads provide a consistently wide stance and better leveling on uneven ground.

- Rack and pinion turret rotation
- All control valves are located for easy service
- Mounts on standard, single rear axle trucks with the versatility of two mounting configurations
- Horn and stop switches located at each control station
- Accessory line adds to versatility

Like all Nationals, the Series 200 goes anywhere you can drive a truck. It sets up fast. Operates easily. Works productively. It is a cost-efficient loading and lifting system that will boost your production and pay its way.

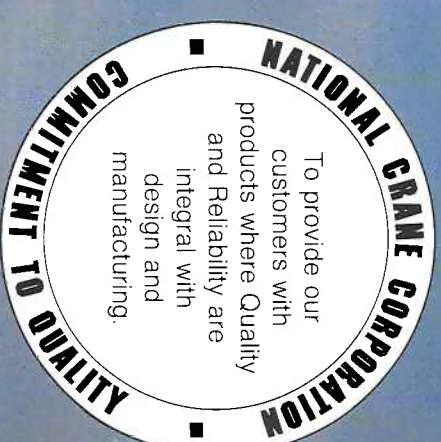

National's anti two block system is standard on all National cranes (as of June 1, 1986). Photos in this brochure taken prior to that date may not show the crane equipped with the current standard anti two block protection system.

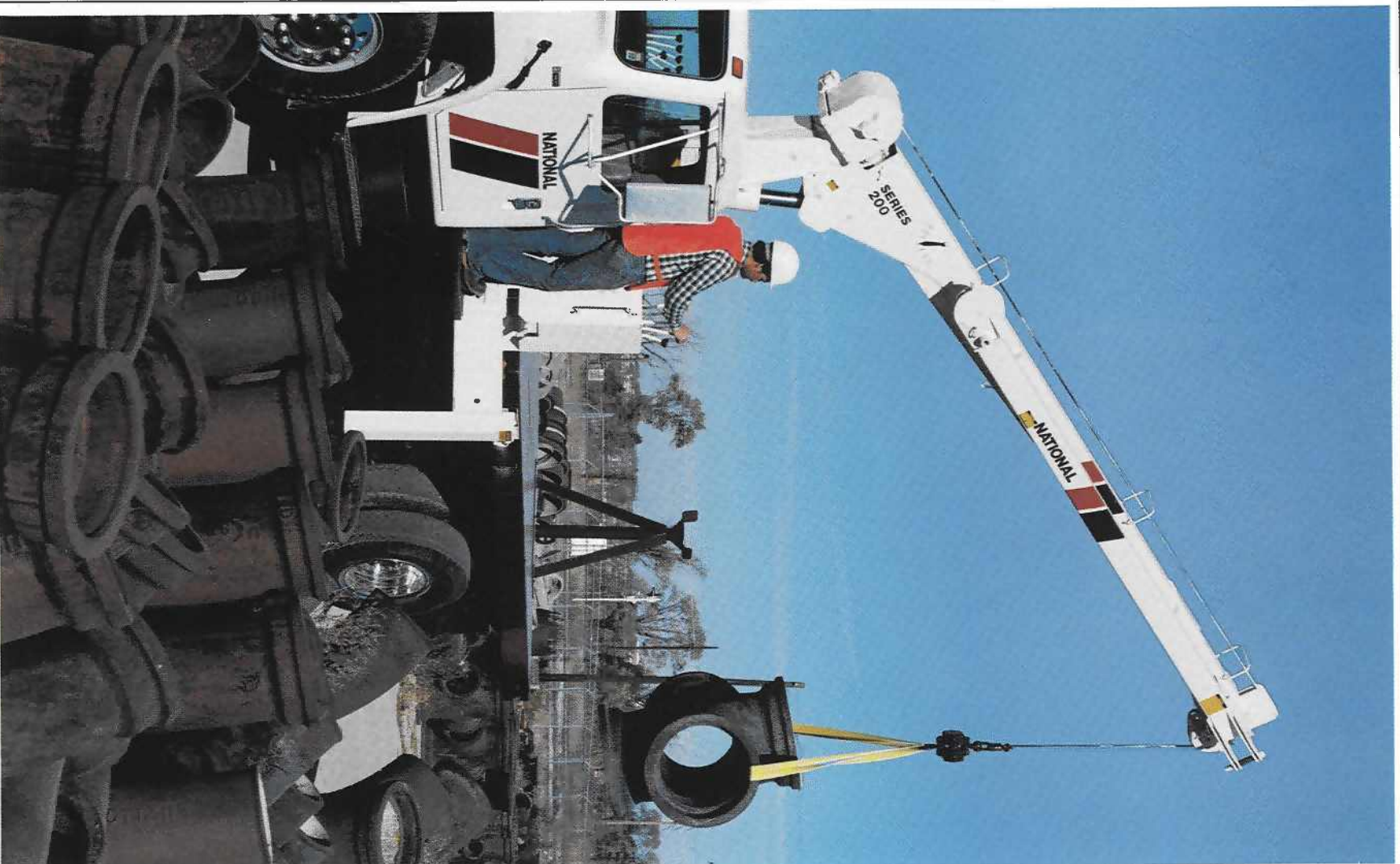

Strong, Four-Plate Booms.

We fabricate our telescoping boom sections from four high-strength steel members welded with perpendicular corners. This box-section construction lets us use thicker top and bottom plates for extra strength. The use of thinner side plates means increased capacity through lower boom weight. Only strong, low alloy steel is used in National booms. It is welded with automatic, low-hydrogen techniques for extra strong seams. Corner seams are ultrasonically tested for proper penetration.

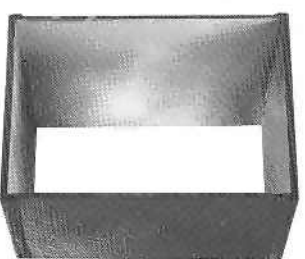

Smooth Extension.

National booms telescope smoothly and easily, even under full load, gliding on extra-smooth, self-lubricating nylon bearing plates.

Dual Controls.

Dual controls are standard on the Series 200. Boom control stations are identical at each control station, so the same hand always works the same function. And we've positioned the stations at platform level for greater visibility and easier operation. Each station is equipped with an engine stop button for safety and a horn for signaling and warnings. The control system utilizes specially-designed notched metering valves for precise control of all movements. All valves are easily reached for fast, easy service.



Less Space.

The Series 200 is built tough, yet compact. Even with the standard access area between the cab and crane, the 200 takes only 34 inches of bed space, leaving more room for payloads. The access area is a passageway, allowing limited operator movement between control stations.



Wide, All-Hydraulic Outriggers.

Series 200 outriggers are fully hydraulic for fast, easy set-up. They extend 12 ft, 1 3/4 in. (3.7m) horizontally and 25 1/2 in. (65cm) vertically from either side of the standard vertical travel, plus extra-large outrigger pads, give you extra stability, even on soft or uneven ground.

Standard automatic check valves prevent settling of outriggers. Cylinders lock automatically when stowed and will not leak down in transit.



Easy Service.

The Series 200 has been engineered, from the frame up, for maximum speed and ease of service. The boom extend cylinder can be removed for service through the end of the boom by simply removing the winch assembly. There's no need for the complex and time-consuming pulling of the second section. All control valves have been specifically located for easy service. Just remove the control console cover and there they are. The oil reservoir has been separated from the crane frame for easy attachment and access on the truck frame. All this means your Series 200 crane will spend less time in maintenance, more time on the job.

Positive Turret Rotation.

The Series 200 gives you the precision of rack and pinion rotation. Our rack and pinion system is simple, reliable and, because it has fewer parts, easy to maintain. Service is convenient: We've also reduced the bulk of the frame above the truck to lower the center of gravity.

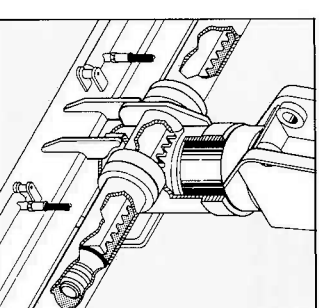

NATIONAL SERIES 200 BOOMS AND JIBS

The versatile Series 200 is now available with working heights to 48 feet (14.6m). Pick the standard fixed boom, the two-section telescoping boom or add our 12-foot (3.7m) side stowing jib for extra reach.

The side of the main boom, not underneath, like many other cranes. That makes rigging and stowing the jib a simple one-operator job. Your National dealer can help you pick the reach and working height that will give you the greatest versatility and working capability.

Boom and Jib Combinations.
Model 216 Base unit equipped with 16 ft. (4.9m) fixed boom.

Telescoping Boom
Model 228 16 (4.9m) to 28 (8.5m) ft., 2-section.

Jib Option
12 ft. (3.7m) straight, side stowing.

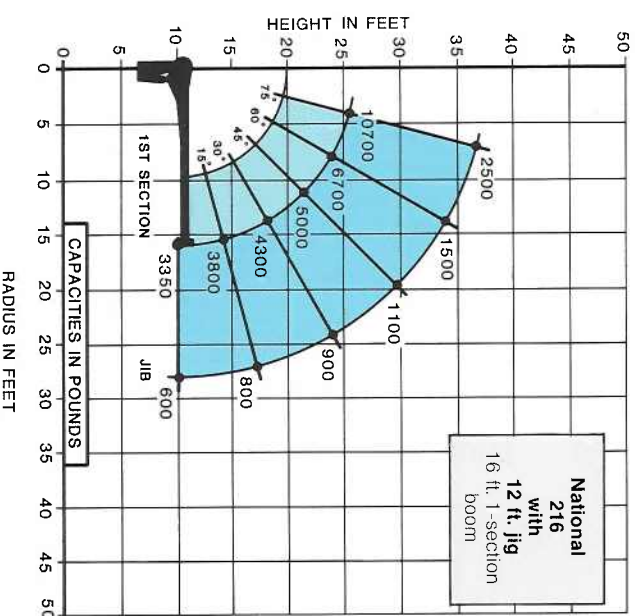
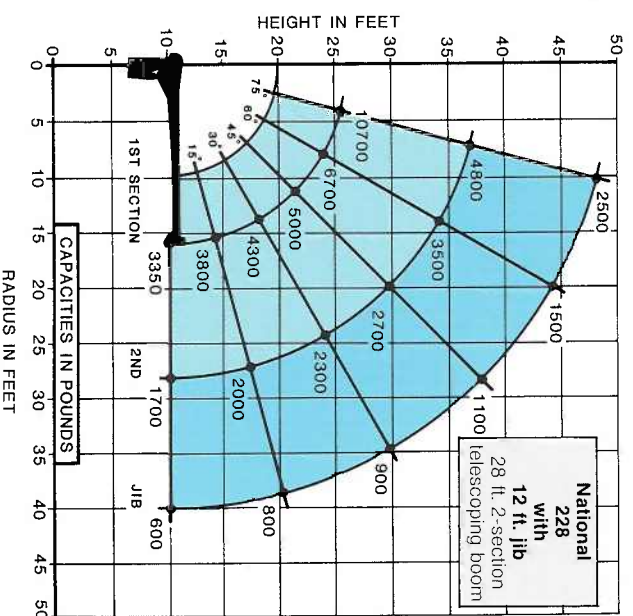

228 Capacity*

(Metric equivalents shown in parentheses)

Radius	All Booms Retracted	All Booms Extended
	Maximum Capacity	10,700 lbs. (4,853kg.)
8' (2.4m)	6,600 lbs. (2,994kg.)	
12' (3.7m)	4,750 lbs. (2,155kg.)	
16' (4.9m)	3,350 lbs. (1,520kg.)	3,200 lbs. (1,452kg.)
20' (6.1m)		2,700 lbs. (1,225kg.)
24' (7.3m)		2,300 lbs. (1,043kg.)
28' (8.5m)		1,700 lbs. (771kg.)

*Capacities shown are for the 228 with the load suspended. radius shown includes increase due to boom deflection. Capacities vary for cranes equipped with jibs or attachments. Consult factory for specific load rating information.

Do not operate crane or accessories within 10 feet (3m) of live power lines.

1. Load ratings shown on this chart are maximum allowable loads with the outriggers properly extended on a firm level surface and the crane factory-recommended truck.
2. The operator must reduce loads to allow for factors such as wind, ground conditions, operating speeds and the effect of freely suspended loads.
3. Overloading this crane may cause structural collapse or instability.
4. Weights of any accessories attached to the boom or load-line must be deducted from the load chart capacities.
5. Do not exceed jib capacities at any reduced boom length.

NATIONAL SERIES 200 WINCH DATA

- Caution:**
- Do not deadhead lineblock against boom tip when extending boom
 - Keep at least three wraps of load line on drum at all times.
 - Use only the specified cable on this machine

1-Part Line	2-Part Line	3-Part Line
These are the ratings of the winch system when reeved accordingly.		

Winch	Cable Supplied	Average Breaking Strength	Lift and Speed	Lift and Speed	Lift and Speed
Tulsa Model 9	7/16 diam. 8x19 IWRC	17,940 lbs. 8.97 tons	5,100 lbs. 85 fpm	10,200 lbs. 42 fpm	10,700 lbs. 28 fpm

All winch pulls and speeds are shown on the third layer. Winch pulls would increase on the first and second layers. Winch line speeds would decrease on the first and second layers. Winch pulls may be limited by the winch capacity or the OSHA 3.5 to 1 cable safety factor. These are shown below:

Winch	Bare Drum Pull	Allowable Cable Pull
Tulsa Model 9	6,100 pounds	5,100 pounds

*Maximum bare drum pull is 6,100 pounds with Tulsa Model 9 winch; however, because of the 3.5 to 1 OSHA safety factor, maximum rated pull on a single line cannot exceed 5,100 pounds.

NATIONAL WARRANTY PARTS AND SERVICE

The National Warranty.

No product is better than its warranty. And no warranty is better than the company behind it.

We didn't get to be America's largest manufacturer of truck-mounted telescoping and articulating cranes by building less than the best. Or backing them with less than a comprehensive warranty.

Our warranty covers your crane against defects in materials or workmanship for **six full months** from the date of shipment, subject to the conditions of the warranty.

When you select a National crane, you're getting more than just a crane. You're getting a nationwide dealer warranty service network, strong warranty protection and our special concern for every product we make.

Read our warranty. Then, don't settle for less. For complete information, write National Warranty Service, Waverly, NE 68462.

The National Parts System.

Authorized National Crane dealers maintain a parts supply to support the National cranes in each dealer's area. If a dealer cannot immediately supply a needed part, the factory can normally provide the part to the dealer within 48 hours on request. National's responsiveness to dealer requests means that your crane will be back on the job fast. National maintains a highly trained Service and Parts staff to answer dealer service questions and expedite parts shipping.

The National Service Center.

Just west of Lincoln, Nebraska, we maintain a well-equipped service center. Here, we do all our factory crane mounting.

The central location of our Lincoln Service Center makes it easy to return cranes for special modifications or extreme repairs. Most National dealers can perform all but the most unusual modifications or most serious repairs.

Should you need to return your crane to us for modification, warranty repair or other service, we will give it priority care and see it's returned as soon as possible.

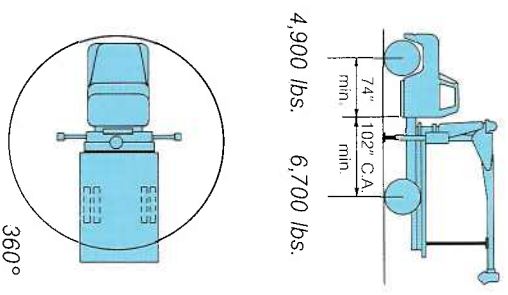
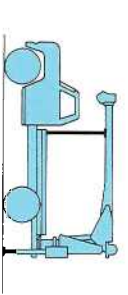

Mounting Configurations	Configuration 1	Configuration 2
The versatility of the Series 200 can be enhanced by the mounting configurations described at the right. The configurations are based on the 228 with an 85% stability factor. The complete unit must be installed in accordance with factory requirements and a test performed to determine actual stability and counterweight requirements since individual truck chassis vary.	This is the most popular and least expensive choice for a wide variety of jobs. It requires counterweight in the underside of the bed for full capacity 360° around the truck. Care must be taken in truck selection. Consult your dealer.	A rear-mounted 200 has many advantages. It allows the operator to effectively utilize the close-in working area to lift heavier loads. Provides 360° solid stability at full-rated loads. And requires a lower front axle weight rating than standard behind-the-cab mounts.
Stable	360°	360°
Gross Axle Weight Rating (GAWR), Front	9,000 lbs.	Contact factory
Gross Axle Weight Rating (GAWR), Rear	15,000 lbs.	Contact factory
Wheelbase (WB)	171 inches	Contact factory
Cab to axle/trunnion (CA/CT)	102 inches	Contact factory
Frame Section Modulus (SM) under crane and through suspension	15 inch ³	Contact factory
or 110,000 PSI	12 inch ³	Contact factory
Stability Weight Front*	4,900 lbs.	Contact factory
Stability Weight Rear*	6,700 lbs.	Contact factory
Estimated Average Final Weight	16,000 lbs.	Contact factory
NOTES: (1) GAWR means Gross Axle Weight Rating and is dependent on all components of the vehicle such as axles, tires, springs, frame, etc. meeting manufacturer's recommendations. Always specify GAWR when purchasing trucks. (2) Minimum axle requirements may increase with use of longer wheelbase, service bodies or diesel engines. (3) Tandem axle trucks must be used for hauling larger payloads. (4) Diesel engines require variable speed governor and energize-to-run fuel solenoid for smooth crane operation. (5) 7,000 pound front axle can be used in certain applications but there are several variables that could cause axle overloads such as diesel engines, longer CA, large fuel tanks, etc. Contact factory for further information.	 <p>4,900 lbs. 6,700 lbs.</p> <p>360° full capacity work area</p>	 <p>Contact factory for information</p> <p>360° full capacity work area</p>

*Estimated axle scale weights prior to installation of crane and stabilizers and subbase if required for 85% stability.

Cranes are tough when they are in use, but they can be severely damaged during travel from job to job. The only way a crane can be protected from this type of wear and damage is a strong, solid, boom rest.

Boom Rests:

- Add years to the life of your crane
- Reduce stress on the crane frame
- Protect rotation gear from transit damage
- Remove stress from truck frame
- Spread crane load more evenly
- Reduce maintenance and down time

In addition, boom rests are required to provide a positive way to immobilize your crane for transit.

National Crane supplies two heavy duty boom rests for the strong, sure protection of your Series 200. There is a quality National boom rest to fit your mounting configuration. All Nationals must be fitted with a boom rest. All factory mounted cranes will be supplied with a boom rest.

NOTE: Only shorter booms can be slowed forward.

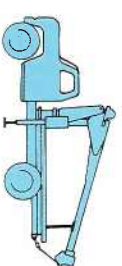

Low-profile rear bed mount for lower center of gravity

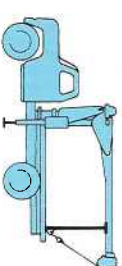

Horizontal rear bed mount for greater load space

Every Series 200 is more than just a crane. It's part of the most complete lifting system available.

National's accessories are designed and manufactured to the same excellent standards as our cranes. This provides you with years of low maintenance, high-productivity service.

Boom Rests:

Get the most from your National 200... make your work easier with low-cost, hardworking accessories from the National Lifting System.

Note: Weights of all accessories attached to the boom or loadline of the crane must be deducted from the effective lifting capacity.

Consult your dealer for specific accessory availability. Some accessories cannot be used in combination with other accessories and/or certain boom/jib combinations.

Remote Control

National offers one-hand remote control for your Series 200. Ideal for use where precise control and total load visibility are required.

Fine metering and instant response mean operators can position loads or work platforms easily.

National's remote controls are built with solid state circuitry and few working parts. They are designed for reliability. You will be impressed with the high operating speeds and modular design.

Available in two models: R4 with tilt, turn, telescope and winch functions, and R3 with tilt, turn, and telescope only. R3 should be used to control cranes from basket, using optional extension cables. A priority control valve, operated by a trigger on the remote control unit, regulates oil flow and gives you fingertip speed control over all crane functions.

National's remote control is the lightweight, easy-to-use way to add extra versatility to your crane. Consult your dealer or the factory for availability.

Model R3

Tilt, turn and telescope

Model R4

Tilt, turn, telescope and winch.

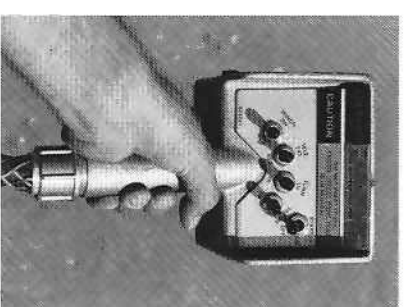

One Person Basket.

Strong, lightweight fiberglass basket with 300 (136Kg) pounds capacity puts personnel where you want them for tough maintenance and installation jobs. Optional dual basket bracket for two basket operation on main boom. (Note: Jib will accommodate only one basket.) Easy on-off Safety bells included. With basket(s) attached to the crane, the crane must not be operated at a position where the crane load chart shows less than the following capacities:

- One fiberglass basket—550 pounds (249kg.)
- Two fiberglass baskets—1,100 pounds (499kg.)

Model B1 Model B1-L

With lock

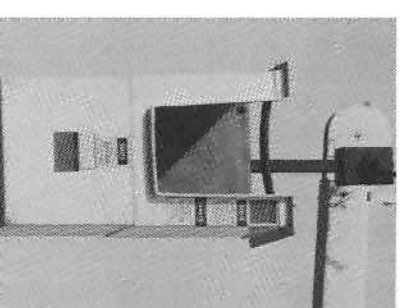

Caution

Do not operate cranes or accessories within 10 feet (3m) of live power lines, including:
 • Remote Controls
 • One Person Basket

Pallet Fork.

Turns your Series 200 into a versatile, payload-packing fork lift. Great for delivering palletized material right where you want it. 4,400 lbs. (1,814kg.) capacity with adjustable throat and teeth. Handles most loads with ease.

- Capacity:** 4,400 lbs. at 20" center 41" to 65"
- Throat Opening:** (adjustable) 38"
- Tooth Length:** 33.5" to 57" (outside to min. max.)
- Weight:** 350 lbs.

Model MKF
 (Manual leveling, adjustable throat)

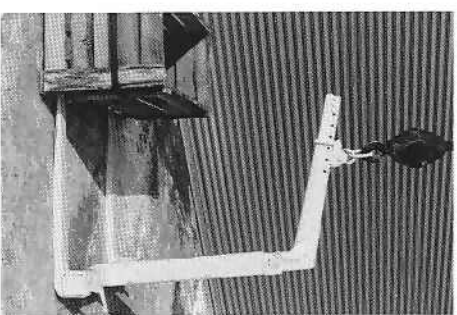

Anti Two Block

Two blocking occurs when the winch cable and attachments contact the underside of the boom sheave case, whether by winching up or extending the boom without paying out the winch cable. When this happens, the winch cable can be damaged by crimping or over tensioning. The anti two block option prevents cable damage by sensing the position of the winch cable end attachments with respect to the sheave case and shutting down the functions that can cause two blocking.

Model ATB/HAS
 (with hydraulic capacity alert system)

Model ATB
 (without hydraulic capacity alert system)

Model ATBu
 (for use with jibs only, add to above options)

Capacity Alert Systems

National offers two capacity alert options. The audible-visual capacity alert system is designed to alert the operator when he reaches a maximum capacity condition on the crane structure. This system activates the truck horn when the capacity load is exceeded on the main boom.

The hydraulic capacity alert system is a hydraulically operated, maximum capacity sensing device that is designed to stop all of the normal crane functions that cause overload when maximum capacity is exceeded on the main boom. Neither of these systems is applicable to jib and stability capacities.

Model AAS
 (Audible capacity alert system)

Model HAS
 (Hydraulic capacity alert system)

Caution

Do not operate cranes or accessories within 10 feet (3m) of live power lines, including:

- One Person Basket
- Remote Controls
- Pallet Fork
- Anti Two Block
- Capacity Alert Systems

Do not exceed jib capacities at any reduced boom lengths.

Caution

Do not operate cranes or accessories within 10 feet (3m) of live power lines, including:

- Pallet Fork
- Anti Two Block
- Capacity Alert Systems

General

Construction: Low-alloy, high-tensile and other steel including T-1, Tri-Ten, Stressproof and Hi-Yield are combined with special low hydrogen welding techniques where advantageous. Standard color: Painted National Ivory.

Frame: H.S.L.A. steel with three point mounting to minimize stress from mounting and truck frame deflection.

Rotation: 390° non-continuous, rack and pinion with 131,000 in./lb. rotation force. Extra-fine metering controls for precision swing control. All hydraulic, minimum of moving parts, excellent serviceability.

Controls: Dual side, stand-up with operator platforms and foot accelerator. Levers identical each side for crane operation. Simultaneous operation of load line and other operations standard.

Outriggers:

All-hydraulic, horizontally-extending. Fully enclosed vertical cylinders. 12 ft. 1 3/4 in. pad center to pad center. 25 1/2 in. vertical travel. Extra large pads. Standard automatic check valves and cylinder locks.

Tilt:

Double-acting hydraulic cylinder raises and lowers boom. Butt-mounted safety holding valve prevents boom fall in event of hose failure.

Boom:

16 ft. fixed, or 2-section telescoping, 16 ft. retracted length, 28 ft. fully extended. Boxed construction. Telescopes hydraulically under rated loads on self-lubricating nylon plates. Excellent serviceability, extend cylinder can be removed without pulling second section boom.

Winch:

Worm gear with automatic friction brake and hydraulic motor control valve brake. Equipped with 125 ft. of

7/16-in x 19 IWRC spin-resistant 8.97-ton breaking strength wire rope. Line pull and speed: 1st layer, 6,100 lbs./70 fpm; 2nd layer, 5,600 lbs./77 fpm; 3rd layer, 5,100 lbs./85 fpm.*

Pump:

High-pressure, high-speed, balanced-vane double pump with replaceable cartridge. Provides 9 and 25 gpm, maximum.

Filter:

In-line 10 micron cartridge.

Cylinders:

All shafts chrome-plated and stress-relieved. Polyurethane "U" cup packing and seals. All load supporting cylinders have direct-mounted load holding valves. Butt-mounted.

Valves:

Main control valves are stackable, 4-Way, 3-position with main system relief set at 2,500 PSI to protect pump. Low-effort spools with valve metering. Fittings and valves

engineered for maximum serviceability. Emergency stop and horn switches on console.

Hose:

All high pressure, wire braid reinforced hose with minimum 4 to 1 safety factor.

Operating Speeds:

Rotate 390°-37 sec. (1.8 rpm). Tilt up, -10° to +75°-15 sec. Tilt down, +75° to -10°-10 sec. Boom retract: 18 sec. Boom extend: 24 sec. When using remote control, function speeds will be reduced by approximately 50% for smooth operation. Speeds assume no load.

Oil Tank:

30-gallon capacity. Truck frame mounted for easy access.

Bed Space:

34 inches.

Capacity Alert Systems:

Devices available to reduce possibility of operator error. See your dealer.

*Maximum bare drum pull is 6,100 pounds with Tulsa Model 9 winch, however, because of the 3.5 to 1 OSHA safety factor, maximum rated pull on a single line cannot exceed 5,100 pounds.

