

KOBELCO

HYDRAULIC CRAWLER CRANE
SL6000

Model: SL6000

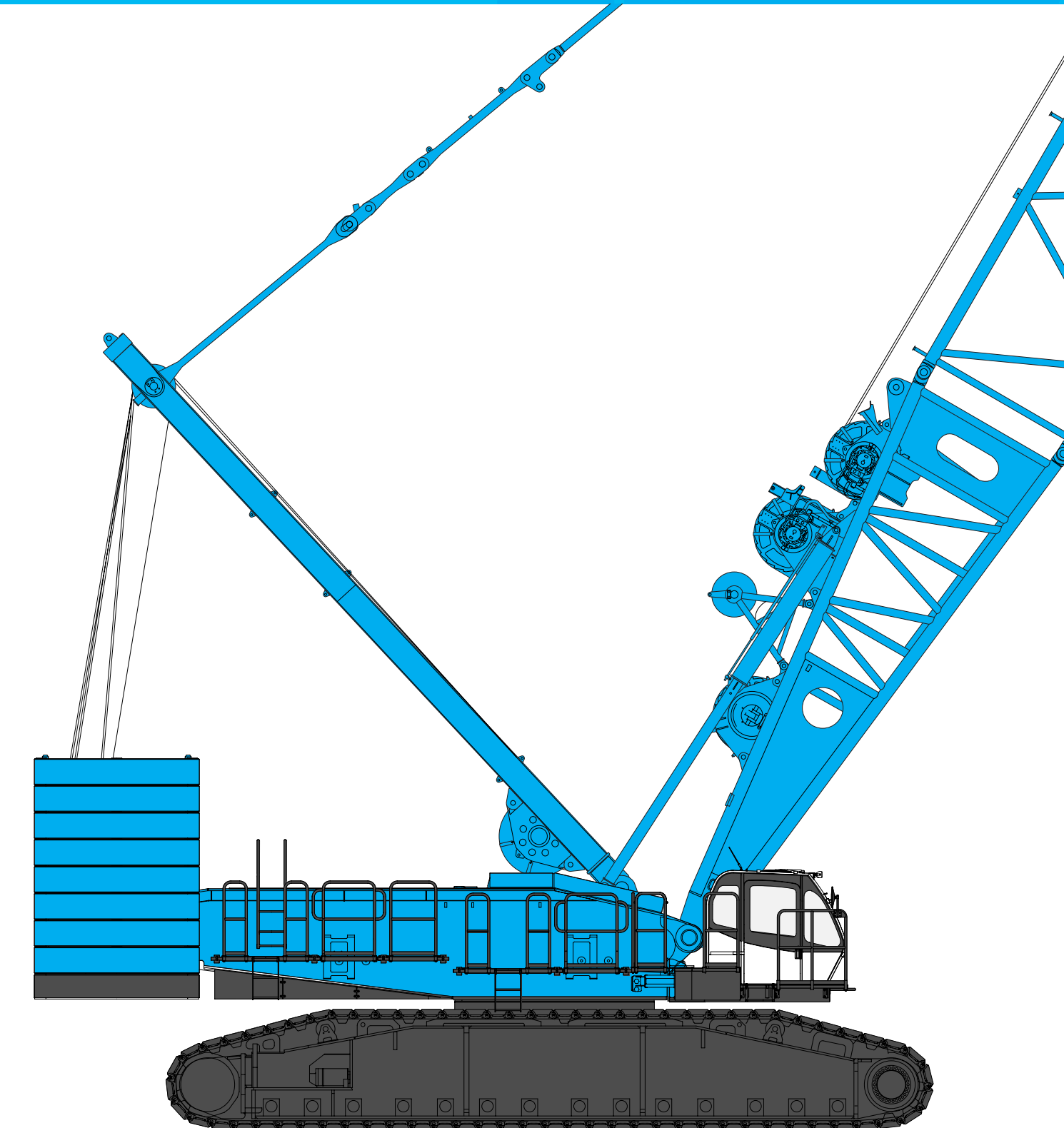

Max. Lifting Capacity: 550 ton x 8.3 m
Max. Crane Boom Length: 126 m
Max. Luffing Jib Combination: 84 m + 84 m

CONFIGURATION

STD

Long Boom



Max. Lifting Capacity:
98 metric tons x 15.0 m
Max. Boom Length: 108 m

STD

Luffing Boom



Max. Lifting Capacity:
300 metric tons x 9.0 m
Max. Boom Length: 84 m

HL

Luffing Boom



Max. Lifting Capacity:
300 metric tons x 8.5 m
Max. Boom Length: 84 m

STD

Heavy Duty Crane Boom



Max. Lifting Capacity:
450 metric tons x 6.7 m
Max. Boom Length: 42 m

HL

Heavy Duty Crane Boom



Max. Lifting Capacity:
367.5 metric tons x 8.3 m
Max. Boom Length: 42 m



SHL



Luffing Jib

Max. Lifting Capacity:
200 metric tons x 14.4 m
Max. Combination: 84 m + 84 m

SHL



Heavy Duty Crane Boom

Max. Lifting Capacity:
550 metric tons x 8.3 m
Max. Combination: 42 m

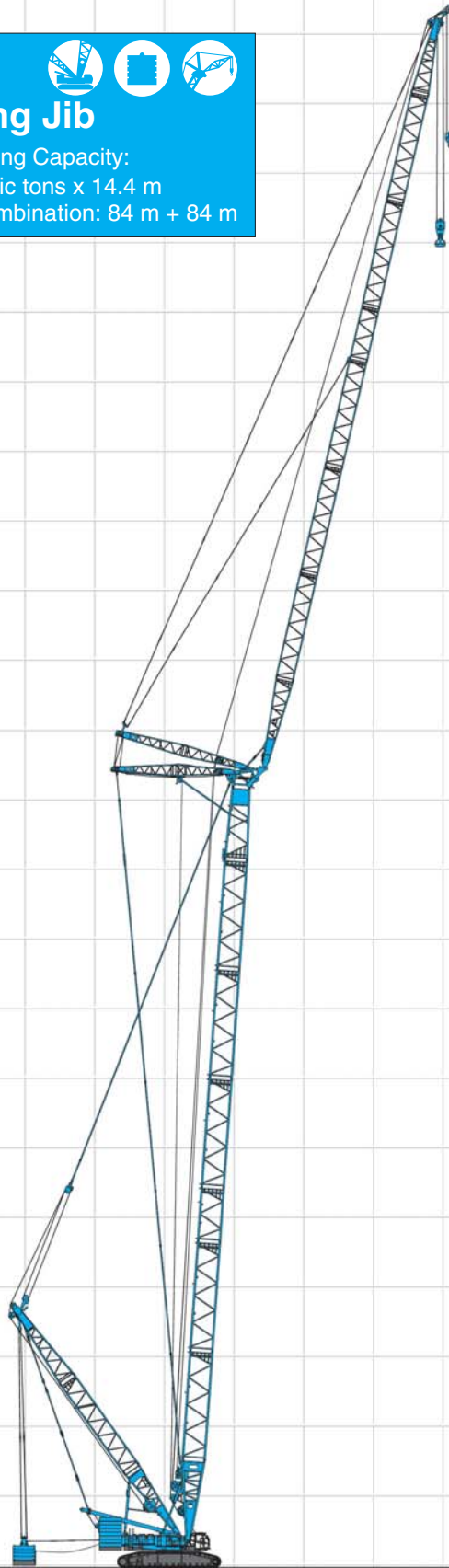

The following abbreviations are used throughout this catalog:
STD: Standard HL: Heavy Lift SHL: Super Heavy Lift

CONFIGURATION

STD



Heavy Fixed Jib (Type A)

Max. Lifting Capacity:
105 metric tons x 20.0 m
Max. Combination: 78 m + 18 m

HL



Heavy Fixed Jib (Type B1)

Max. Lifting Capacity:
120 metric tons x 20.0 m
Max. Combination: 78 m + 18 m

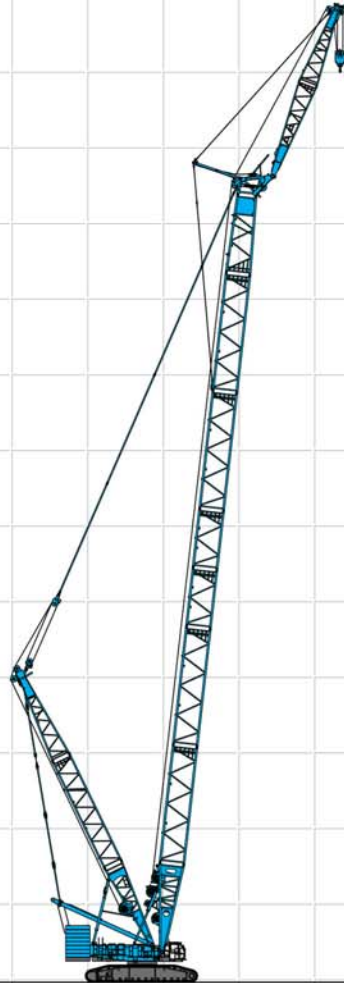
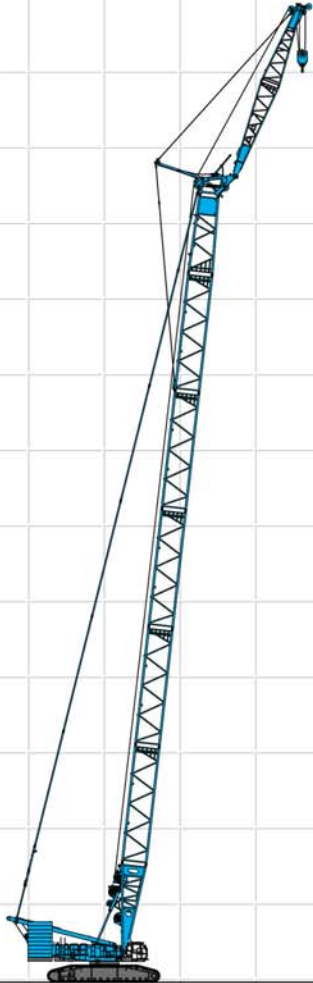

CONTENTS

Configuration	1
Specifications	5
General Dimensions	7

STANDARD

Boom and Jib Arrangements	9
Working Ranges	12
Crane Boom Supplemental Data	19
Heavy Fixed Jib Supplemental Data	21
Luffing Jib Supplemental Data	23
Heavy Duty Crane Boom Lifting Capacities	25
Long Boom Lifting Capacities	25
Heavy Fixed Jib Lifting Capacities	25
Luffing Boom Lifting Capacities	26
Luffing Jib Lifting Capacities	27

HEAVY LIFT

Boom and Jib Arrangements	31
Working Ranges	34
Heavy Duty Crane Boom Lifting Capacities	41
Long Boom Lifting Capacities	41
Heavy Fixed Jib Lifting Capacities	41
Luffing Boom Lifting Capacities	42
Luffing Jib Lifting Capacities	43

SUPER HEAVY LIFT

Boom and Jib Arrangements	47
Working Ranges	50
Heavy Duty Crane Boom Lifting Capacities	59
Long Boom Lifting Capacities	59
Heavy Fixed Jib Lifting Capacities	60
Luffing Boom Lifting Capacities	61
Luffing Jib Lifting Capacities	62

Transportation Plan	67
---------------------------	----

Parts and Attachments	69
-----------------------------	----

SHL Heavy Fixed Jib (Type B2)

Max. Lifting Capacity:
120 metric tons x 20.0 m
Max. Combination: 78 m + 18 m



SHL Heavy Fixed Jib (Type C)

Max. Lifting Capacity:
105 metric tons x 30.0 m
Max. Combination: 102m + 18 m

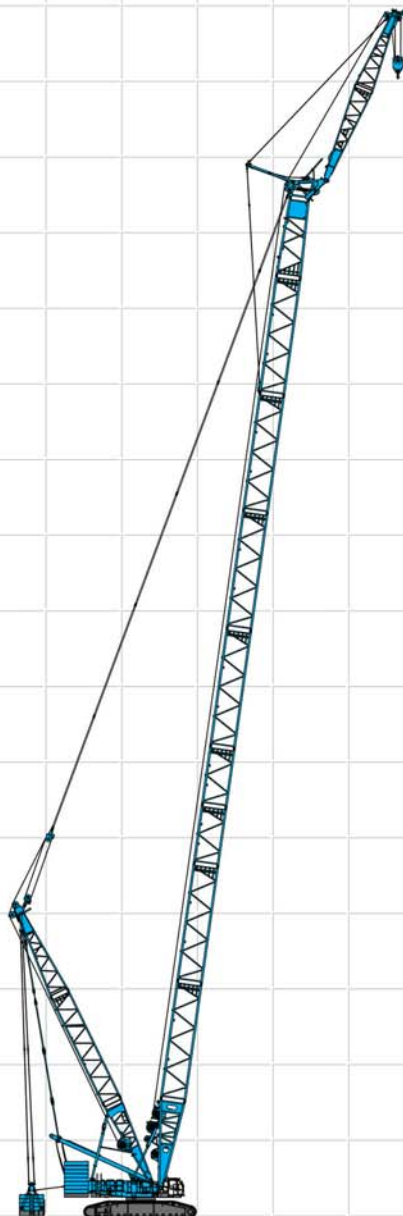

SPECIFICATIONS



Power Plant

Model: Hino diesel engine E13C-UV
Type: Water-cooled, direct fuel injection, with turbocharger
Complies with US EPA Tier III.
Displacement: 12.913 liters
Rated Power: 320 kW/2,000 min⁻¹
Max. torque: 1,650 N·m/1,300 min⁻¹
Cooling system: Liquid, recirculating bypass
Starter: 24 V/6 kW
Radiator: Corrugated type core, thermostatically controlled
Air cleaner: Dry type with replaceable paper element
Throttle: Twist grip type hand throttle, electrically actuated
Fuel filter: Replaceable paper element
Batteries: Two 12V x 136Ah/5HR capacity batteries, parallel connected.
Fuel tank capacity: 600 liters



Hydraulic System

Six variable displacement piston pumps are driven by heavy-duty pump drive. Two variable displacement pumps are used in H1 (main hook hoist) and right hand side propel circuit. Two variable displacement pumps are used in H2 (auxiliary hook hoist) and left hand side propel circuit. One of the other two pumps is used in W1 (boom), W2 (jib) or W3 (SHL mast) hoist circuit, and the other is used in the swing circuit.
Control: Full-flow hydraulic control system for infinitely variable pressure to all winches, propel and swing.
Controls respond instantly to the touch, delivering smooth function operation.
Cooling: Oil-to-air heat exchanger (plate-fin type)
Filtration: Full-flow and bypass type with replaceable element
Electrical system: All wiring corded for easy servicing, individual fused branch circuits.

Max. relief valve pressure: 31.9 MPa {325 kgf/cm²}
Reservoir capacity: 710 liters



Boom Hoisting System

Powered by a hydraulic motor through a planetary reducer.
Brake: A spring-set, hydraulically released multiple-disc brake is mounted on the boom hoist motor and operated through a counter-balance valve.
Drum lock: External ratchet for locking drum.
Drum: Double drum, grooved for 28 mm dia. wire rope.
Line speed: Double line on first drum layer
Hoisting/Lowering: 20~2 m/min x 2
Boom hoist reeving: 30 parts of 28 mm dia. high strength wire rope
Boom backstops: Required for all boom lengths



Load Hoist System

H1 and H2 drums for load hoist powered by a hydraulic variable plunger motors, driven through planetary reducers.
Brake: A spring-set, hydraulically released multiple-disc brake is mounted on the hoist motor and operated through a counter-balance valve.
Drum lock: External ratchet for locking drum.
Drums:
H1 and H2:
640 mm P.C.D. x 1,367.1 mm Lg. wide drum, grooved for 28 mm wire rope. Rope capacity is 830 m working length and 1,080 m storage length.
Note: Rope lengths listed above denote drum capacity and may differ from actual rope lengths supplied when machinery is shipped.
Line speed: 110 ~ 3 m/min
Single line on the first layer
Rated line pull: 137 kN {14.0 tf}



Swing System

Swing unit is powered by hydraulic motor driving spur gears through planetary reducers (4 sets), the swing system provides 360° rotation.
Swing parking brakes: A spring-set, hydraulically released multiple-disc brake is mounted on swing motor.
Swing circle: Triple-row roller bearing with an integral internally cut swing gear.
Swing speed: 0.9 min⁻¹ {rpm}



Upper Structure

Torsion-free precision machined upper frame. All components are located clearly and service friendly. Engine with low noise level.



Cab & Control

Totally enclosed, full vision cab with safety glass, fully adjustable, high backed seat with a head-rest and armrests, and intermittent wiper and window washer (roof and front window).
Cab fittings:
Air conditioner, convenient compartment (for tool), cup holder, ashtray, cigarette lighter, sun visor, roof blind, tinted glass, floor mat, foot-rest, shoe tray
Controls:
Five adjustable levers for all winches and swing controls



Lower Structure

Steel-welded carbody with axles. Crawler assemblies are designed with quick disconnect feature for individual removal as a unit from axles. Crawler belt tension is maintained by hydraulic jack force on the track-adjusting bearing block.

Crawler drive: Two independent hydraulic propel drive is built into each crawler side frame. Each drive consists of a hydraulic motor propelling a driving tumbler through a planetary gear box. Hydraulic motor and gear box are built into the crawler side frame within the shoe width.

Crawler brakes: Spring-set, hydraulically released parking brakes are built into each propel drive.

Steering mechanism: A hydraulic propel system provides both skid steering (driving one track only) and counter-rotating steering (driving each track in opposite directions).

Track rollers: Sealed track rollers.

Shoes (flat): 1,500 mm wide each crawler

Max. travel speed: 1.0/0.4 km/h

Max. gradeability: 20%



Weight

Including base machine, counterweights = 180 t, carbody weights = 50 t, 24 m boom with heavy boom tip and 450 t hook block. Not include quick connection device and upper translifter.

Weight: 424 metric ton

Ground pressure: 136 kPa {1.4 kgf/cm²}



Attachment

Boom and Jib:

Welded lattice construction using tubular, high-tensile steel chords with pin connections between sections.

Boom and Jib Length

	Min. Length (Min. Combination)	Max. Length (Max. Combination)
STANDARD		
Crane Boom	24 m	108 m
Heavy Fixed Jib	66 m + 18 m	78 m + 18 m
Luffing Jib	30 m + 24 m	60 m + 72 m
HEAVY LIFT		
Crane Boom	36 m	108 m
Heavy Fixed Jib	66 m + 18 m	78 m + 18 m
Luffing Jib	36 m + 24 m	66 m + 72 m
SUPER HEAVY LIFT		
Crane Boom	36 m	126 m
Heavy Fixed Jib	66 m + 18 m	78 m + 18 m
	84 m + 18 m	102 m + 18 m
Luffing Jib	36 m + 24 m	84 m + 84 m

Main Specifications (Model: SL6000)

Lift Enhancer	STD	HL	SHL		
HL Mast	-	30 m	30 m		
Additional Weight	-	-	~250 t		
Heavy Duty Crane Boom					
Max. Lifting Capacity	450 t	367.5 t	550 t		
	6.7 m				
Length	24 ~ 42 m	36 ~ 42 m	36 ~ 42 m		
Crane Boom					
Max. Lifting Capacity	300 t	300 t	300 t		
	9 m				
Length	30 ~ 84 m	36 ~ 84 m	36 ~ 84 m		
Long Boom					
Length	90 ~ 108 m	90 ~ 108 m	90 ~ 126 m		
Heavy Fixed Jib					
Max. Lifting Capacity	105 t	120 t	120 t	*1	*2
Max. Combination (Boom) (Jib)	78 m	78 m	78 m	102 m	
	18 m	18 m	18 m	18 m	
Luffing Jib					
Max. Lifting Capacity	184 t	200 t	200 t		
Max. Combination (Boom) (Jib)	60 m	66 m	84 m		
	72 m	72 m	84 m		
Luffing Angle	66° ~ 86°				

Power Plant	
Model	Hino E13C-UV
Engine Output	320 kW/2,000 min ⁻¹ {rpm}
Fuel Tank Capacity	600 liters
Hoist Winch (H1, H2)	
Max. Line Speed	110 m/min (1st layer)
Rated Line Pull (Single line)	137 kN {14.0 tf}
Wire Rope Diameter	28 mm
Wire Rope Length	830 m
Working Speed	
Swing	0.9 min ⁻¹ {rpm}
Travel	1.0/0.6 km/h
Hydraulic System	
Pumps	6 variable displacement
Max. Pressure	31.9 MPa {325 kgf/cm ² }
Hydraulic Tank Capacity	710 liters
Weight	
Working Weight*3	Approx. 424 t
Ground Pressure*3	136 kPa {1.4 kgf/cm ² }
Counterweight	Upper: 180 metric tons
	Lower: 50 metric tons

*1 Heavy Fixed Jib Type B2

*2 Heavy Fixed Jib Type C

*3 Including base machine, counterweights = 180 metric ton, carbody weights = 50 metric ton, 24 m boom with heavy boom tip and 450 metric ton hook block. Not include quick connection device and upper translifter.

GENERAL DIMENSIONS

Crane Boom

Unit: mm

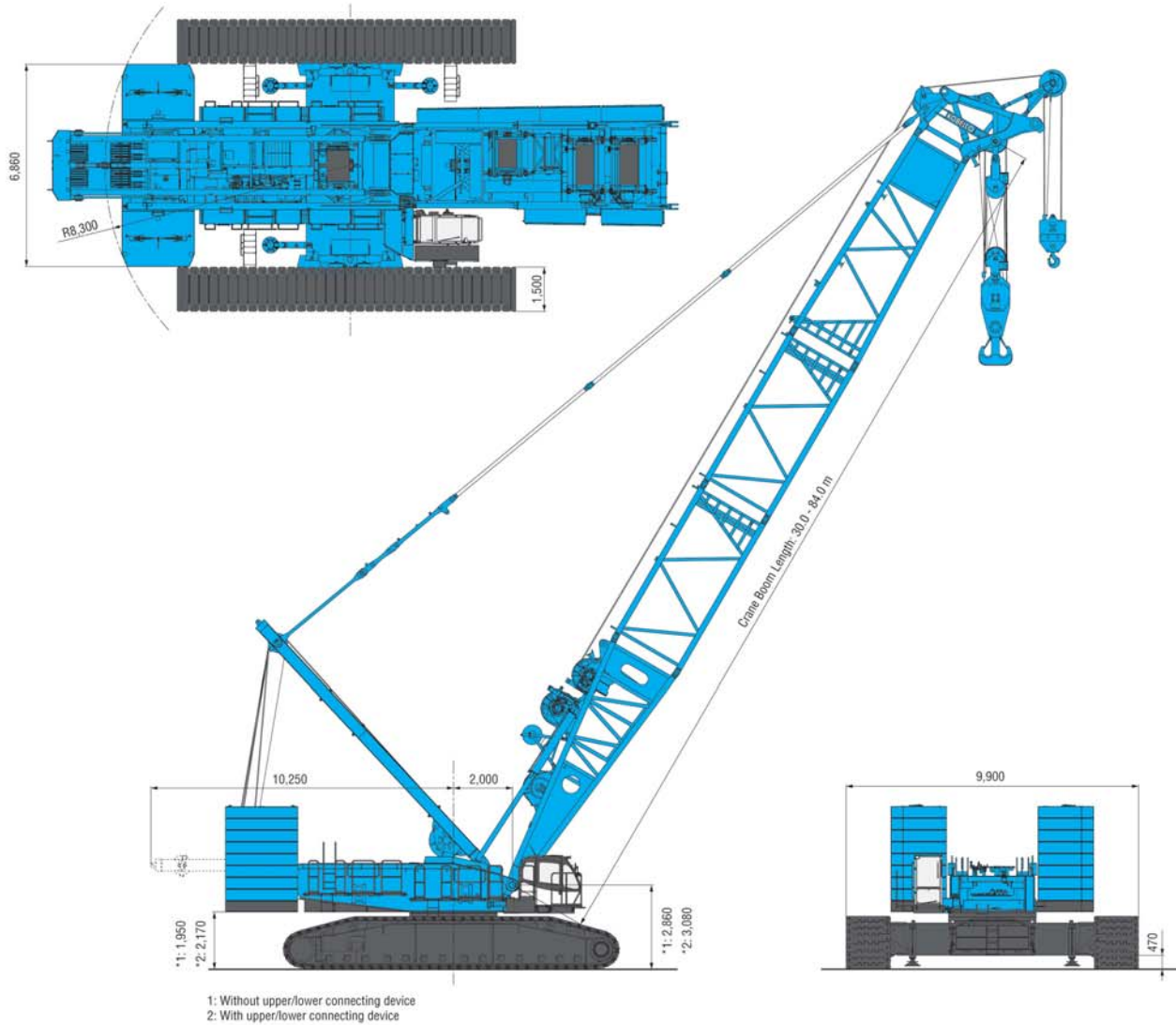

Lift Enhancer



SHL CRANE

SHL LUFFING

Luffing Jib

Unit: mm

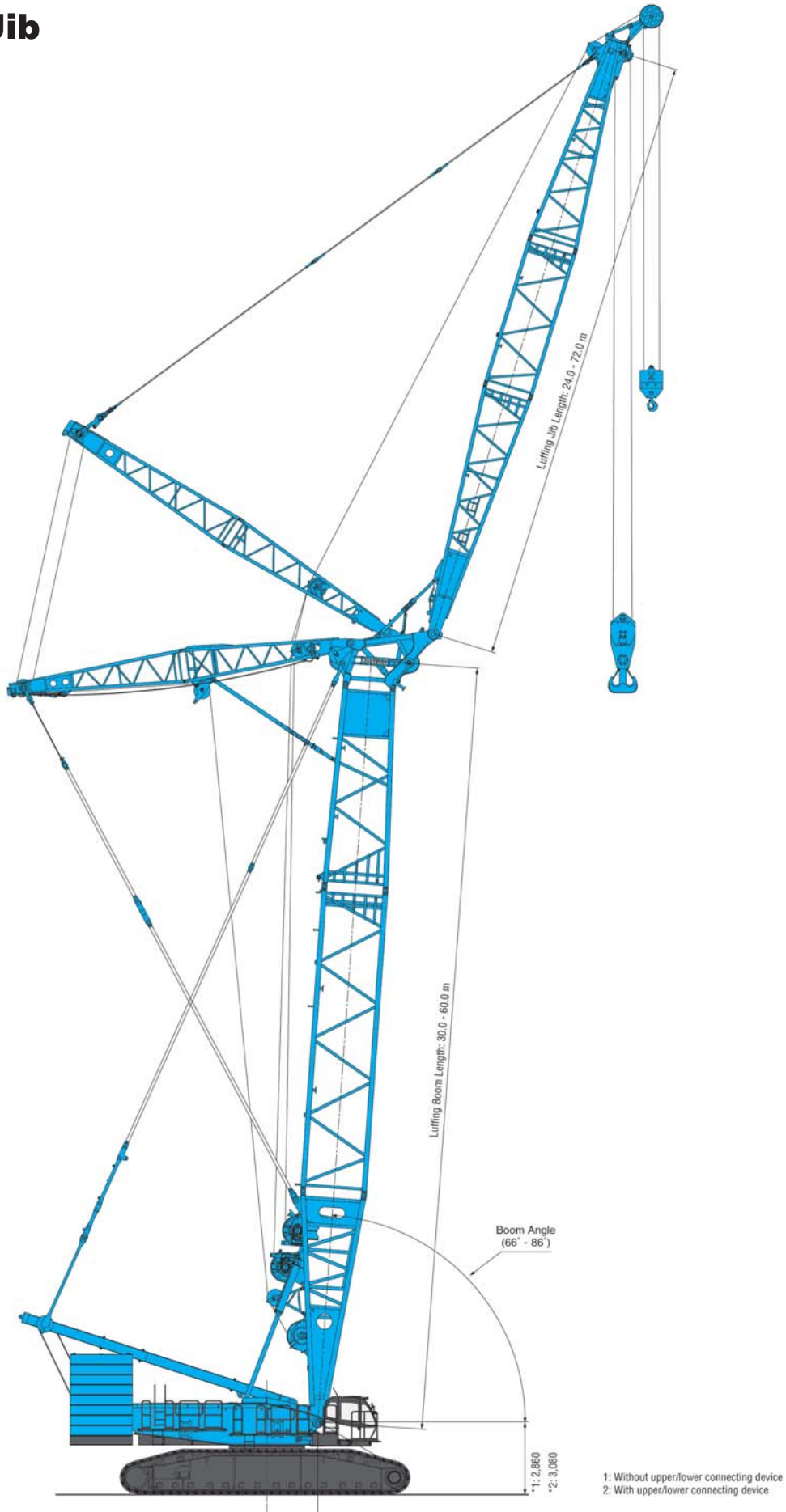

BOOM AND JIB ARRANGEMENTS

Heavy Duty Crane Boom Arrangements

Boom length m (ft)	Boom arrangement
24 (79)	※
30 (98)	※
36 (118)	※
42 (138)	※

Symbol	Boom Length	Remarks
	9.0 m (29.5 ft)	Boom Base
	8.0 m (26.2 ft)	Tapered Boom
	6.0 m (19.7 ft)	Insert Boom
	12.0 m (39.4 ft)	Insert Boom
	1.0 m (3.3 ft)	Boom Top

※ indicates the most flexible combination of insert heavy duty booms, which can be modified to form all shorter heavy duty boom arrangements.

Luffing Boom Arrangements for Crane

Boom length m (ft)	Boom arrangement
30 (98)	※
36 (118)	※
42 (138)	※
48 (157)	※
54 (177)	※
60 (197)	※
66 (217)	※
72 (236)	※
78 (256)	※
84 (276)	※

Symbol	Boom Length	Remarks
	9.0 m (29.5 ft)	Boom Base
	8.0 m (26.2 ft)	Tapered Boom
	6.0 m (19.7 ft)	Insert Boom
	12.0 m (39.4 ft)	Insert Boom
	1.0 m (3.3 ft)	Boom Top

※ indicates the most flexible combination of insert luffing booms, which can be modified to form all shorter luffing boom arrangements.

Long Boom Arrangements

Boom length m (ft)	Boom arrangement
90 (295)	
96 (315)	※
102 (335)	※
108 (354)	※

Symbol	Boom Length	Remarks
	9.0 m (29.5 ft)	Boom Base
	8.0 m (26.2 ft)	Tapered Boom
	6.0 m (19.7 ft)	Insert Boom
	12.0 m (39.4 ft)	Insert Boom
	5.0 m (16.4 ft)	Luffing Insert Jib
	6.0 m (19.7 ft)	Luffing Insert Jib
	12.0 m (39.4 ft)	Luffing Insert Jib
	8.0 m (26.2 ft)	Jib Top

※ indicates the most flexible combination of insert long booms, which can be modified to form all shorter long boom arrangements.

Heavy Fixed Jib Boom Arrangements

Boom length m (ft)	Boom arrangement
66 (217)	※
72 (236)	※
78 (256)	※

Symbol	Boom Length	Remarks
	9.0 m (29.5 ft)	Boom Base
	8.0 m (26.2 ft)	Tapered Boom
	6.0 m (19.7 ft)	Insert Boom
	12.0 m (39.4 ft)	Insert Boom
	1.0 m (3.3 ft)	Boom Top

↗ mark shows the guy line installing position when the fixed jib is used.

※ indicates the most flexible combination of insert luffing booms, which can be modified to form all shorter luffing boom arrangements.

Heavy Fixed Jib Arrangements

Jib length m (ft)	Jib arrangement
18 (59)	

Symbol	Jib Length	Remarks
	10.0 m (32.8 ft)	Jib Base
	8.0 m (26.2 ft)	Jib Top

Luffing Boom Arrangements for Luffing

Boom length m (ft)	Boom arrangement
30 (98)	※
36 (118)	※
42 (138)	※
48 (157)	※
54 (177)	※
60 (197)	※

Symbol	Boom Length	Remarks
	9.0 m (29.5 ft)	Boom Base
	8.0 m (26.2 ft)	Tapered Boom
	6.0 m (19.7 ft)	Insert Boom
	12.0 m (39.4 ft)	Insert Boom
	1.0 m (3.3 ft)	Boom Top

※ indicates the most flexible combination of insert luffing booms, which can be modified to form all shorter luffing boom arrangements.

Luffing Jib Arrangements

Jib length m (ft)	Jib arrangement
24 (79)	
30 (98)	※
36 (118)	※
42 (138)	※
48 (157)	※
54 (177)	※
60 (197)	※
66 (217)	※
72 (236)	※

Symbol	Jib Length	Remarks
	10.0 m (32.8 ft)	Jib Base
	6.0 m (19.7 ft)	Luffing Insert Jib
	12.0 m (39.4 ft)	Luffing Insert Jib
	8.0 m (26.2 ft)	Jib Top

※ indicates the most flexible combination of insert luffing jibs, which can be modified to form all shorter luffing jib arrangements.

WORKING RANGES

Heavy Duty Crane Boom

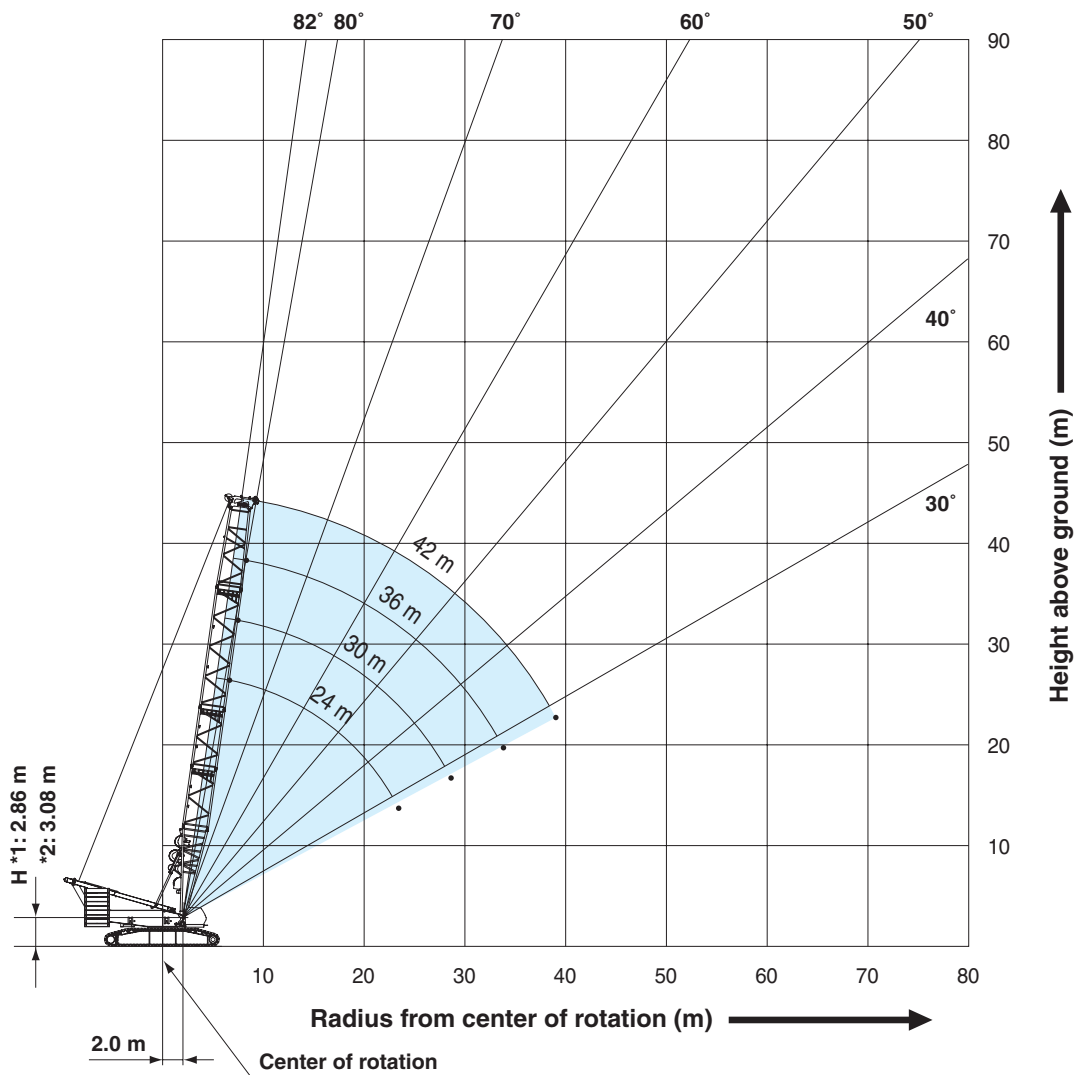

- 1: Without upper/lower connecting device
- 2: With upper/lower connecting device

WORKING RANGES

Luffing Boom

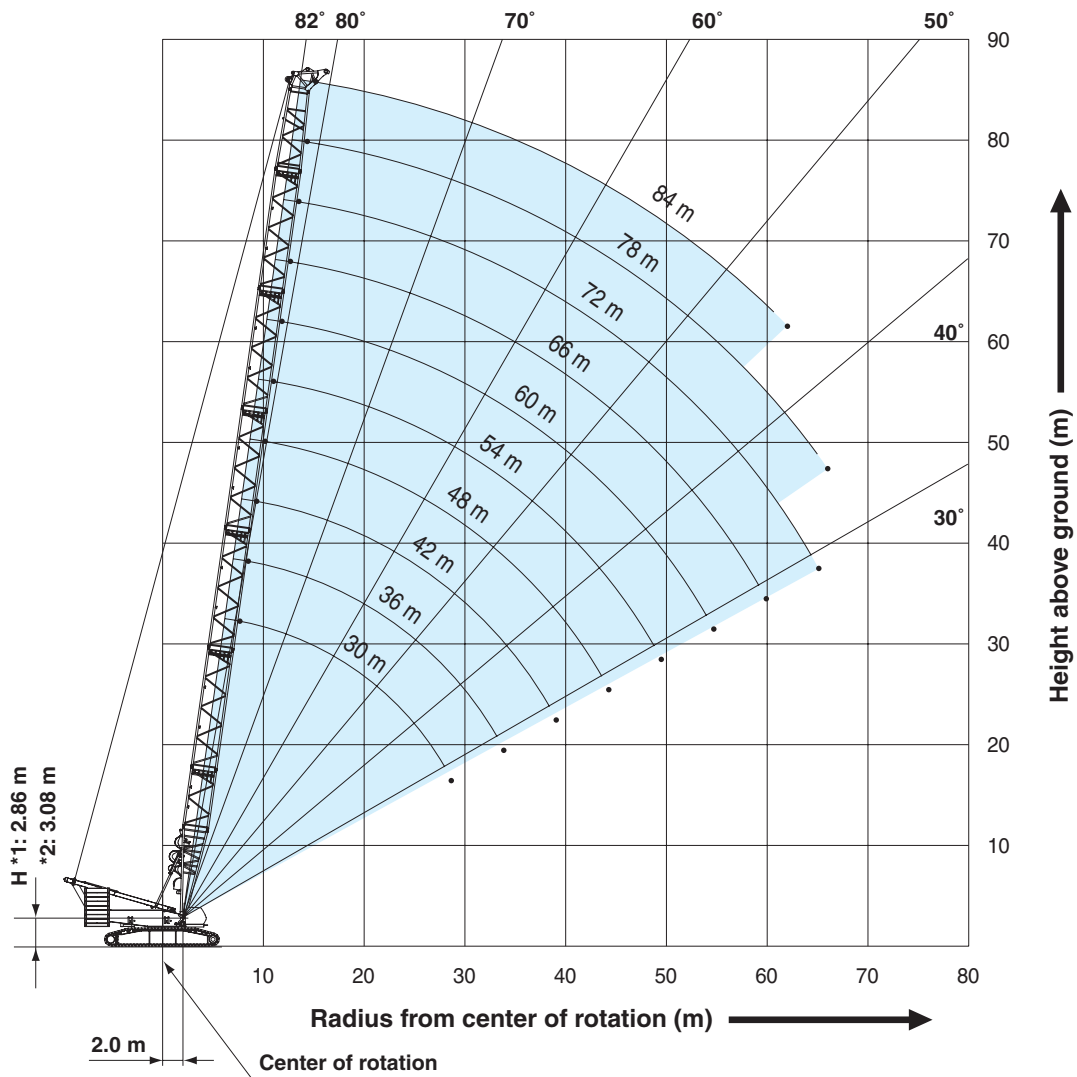

1: Without upper/lower connecting device
2: With upper/lower connecting device

Long Boom

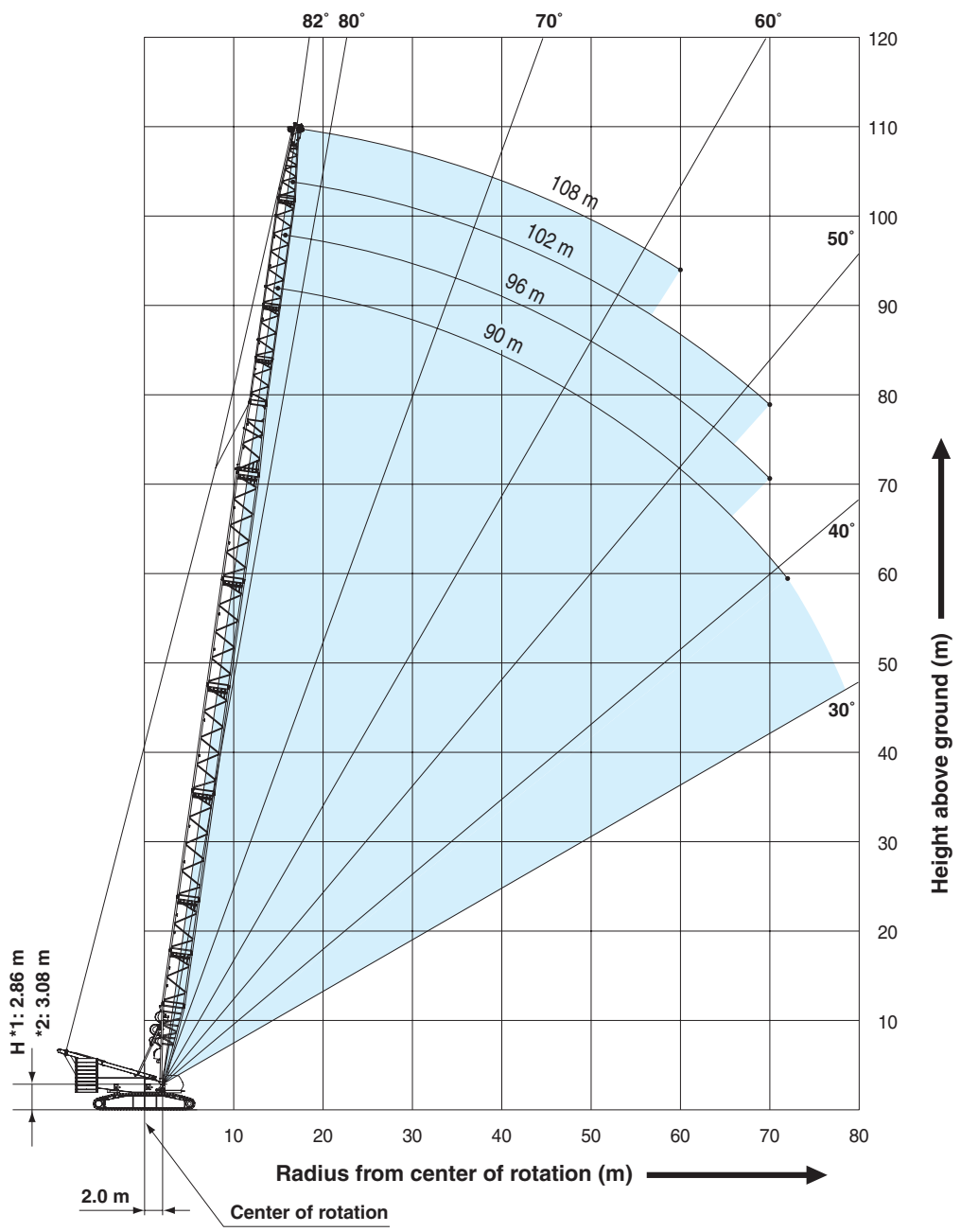

- 1: Without upper/lower connecting device
- 2: With upper/lower connecting device

WORKING RANGES

Heavy Fixed Jib (Type A)

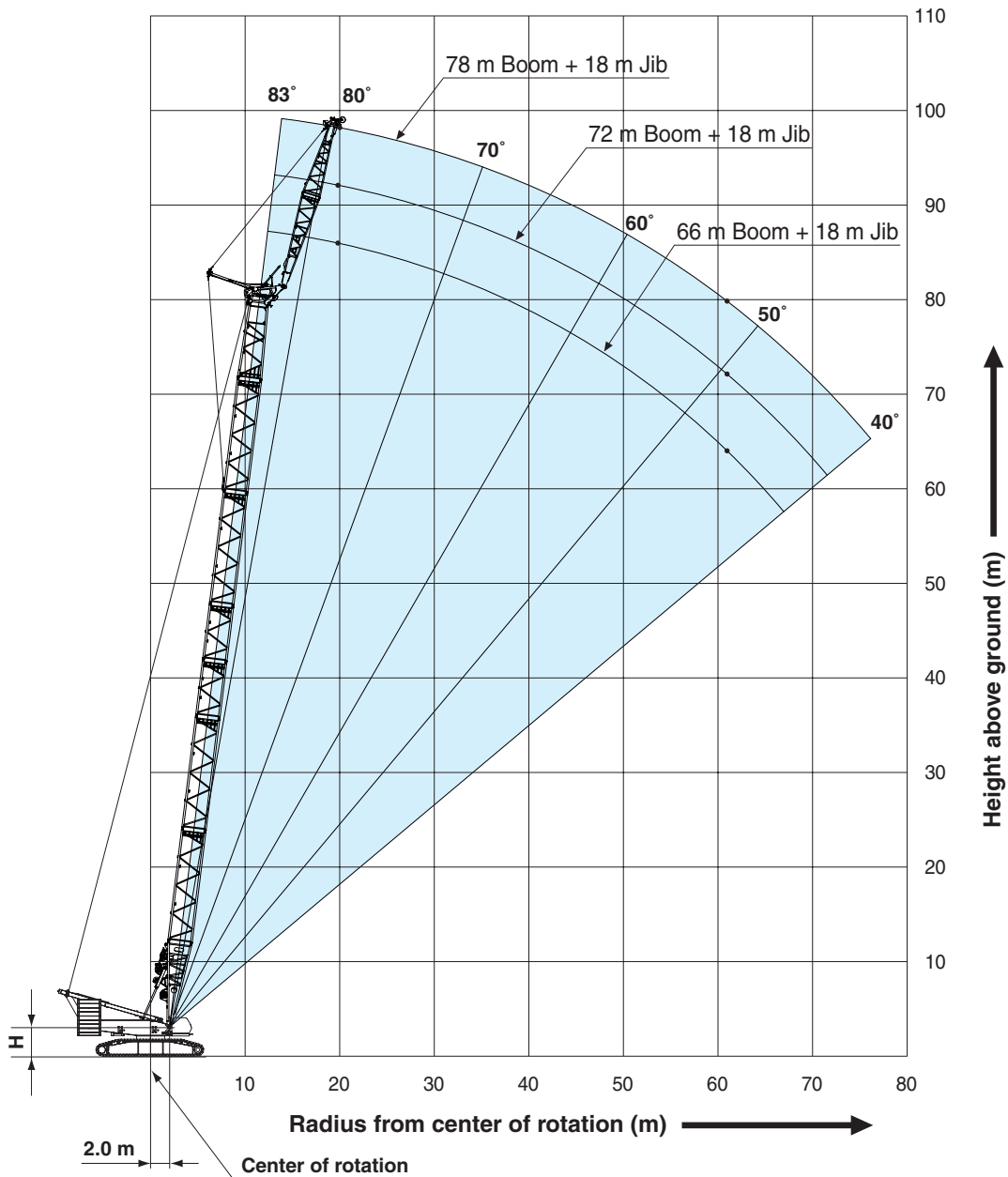

H=2.86 m Without quick connection ring
H=3.08 m With quick connection ring

Luffing Jib

Boom Angle: 86°

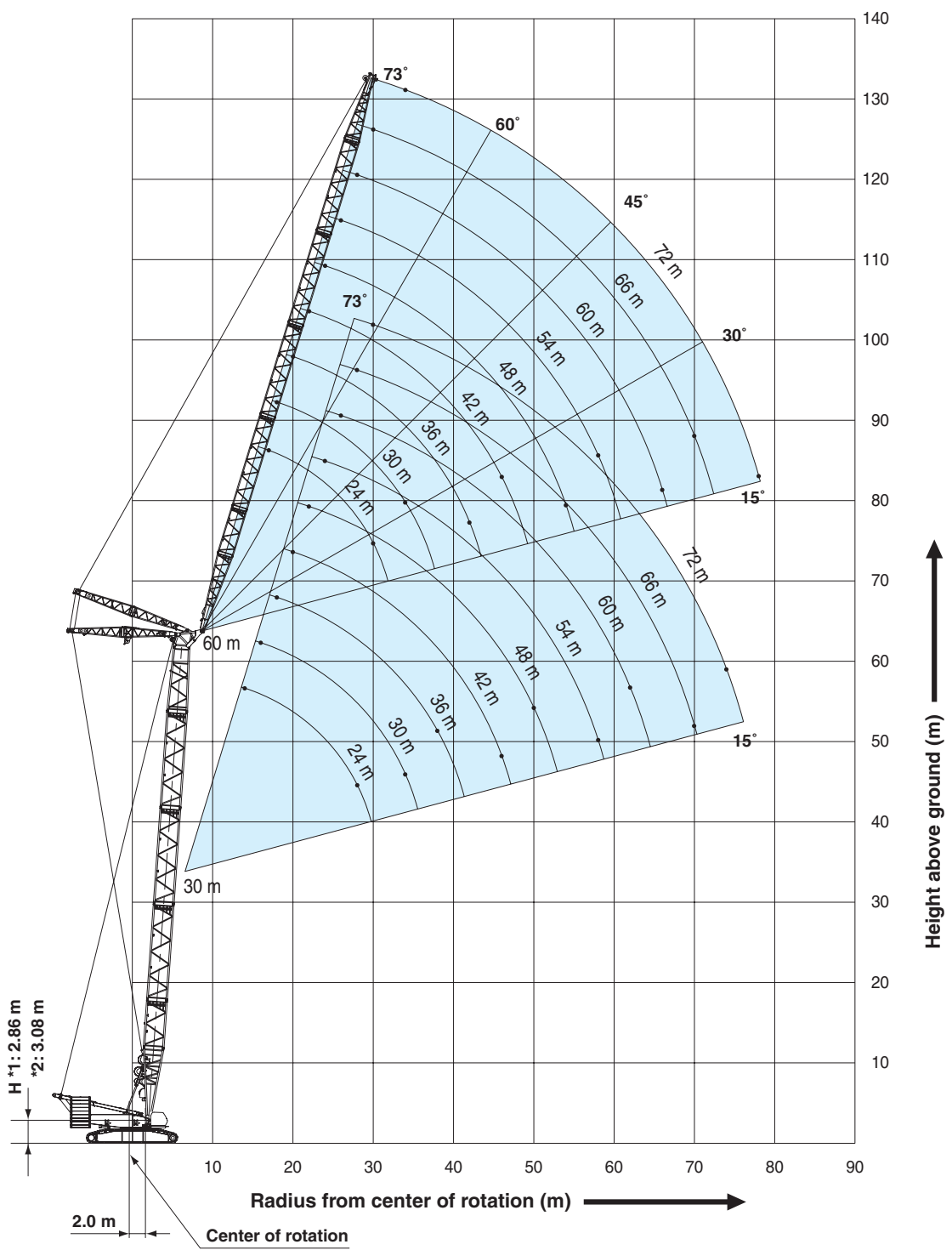

1: Without upper/lower connecting device
 2: With upper/lower connecting device

WORKING RANGES

Luffing Jib

Boom Angle: 76°

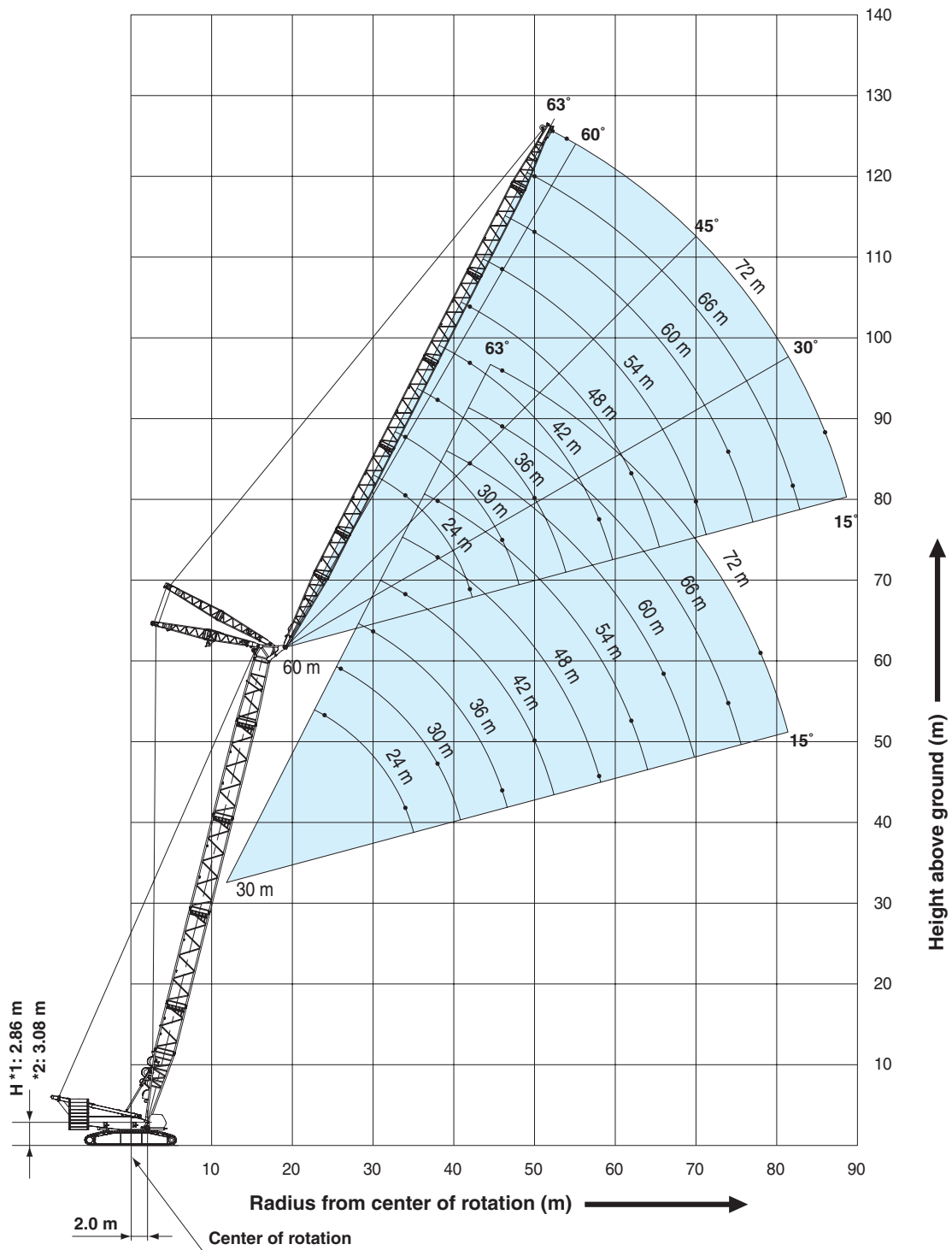

1: Without upper/lower connecting device
 2: With upper/lower connecting device

Luffing Jib

Boom Angle: 66°

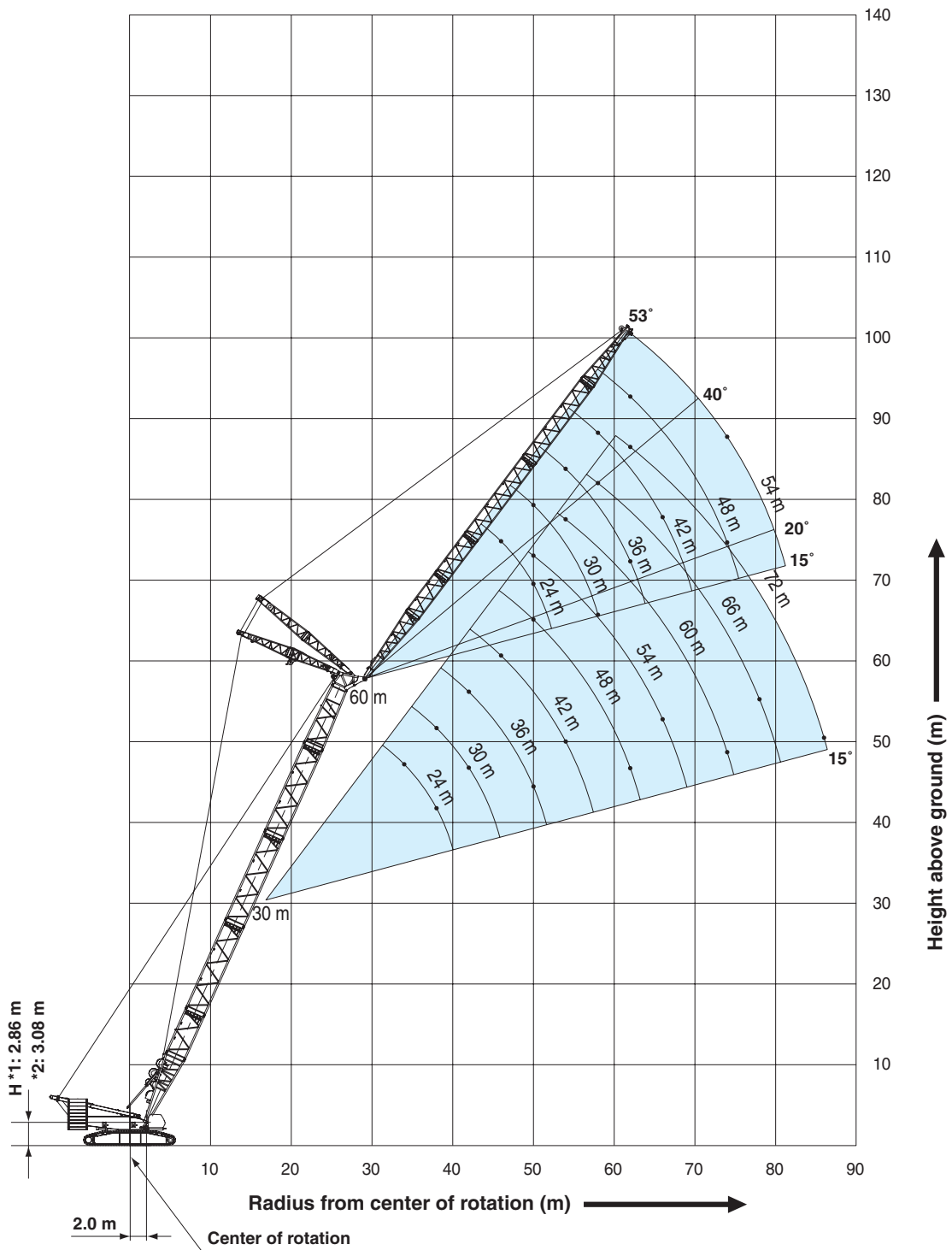

1: Without upper/lower connecting device
2: With upper/lower connecting device

CRANE BOOM SUPPLEMENTAL DATA

1. Designed and rated to comply with EN13000.
2. Operating radius is the horizontal distance from centerline of rotation to a vertical line through the center of gravity of the load.
3. Deduct weight of hook blocks, slings and all other load handling accessories from main boom ratings shown.
4. Ratings shown are based on freely suspended loads and make no allowance for such factors as wind effect on lifted load, ground conditions, out-of-level operating speeds or any other condition that could be detrimental to the safe operation of this equipment. The operator, therefore, has the responsibility to judge the existing conditions and reduce lifted load and operating speeds accordingly.
5. Ratings are for operation on a firm and level surface, up to 1 % gradient.
6. At radii and boom lengths where no ratings are shown on chart, operation is not intended nor approved.
7. Boom inserts, guy pipe and guy lines must be arranged as shown in the "OPERATOR'S MANUAL".
8. Boom hoist reeving is 30 part line.
HL/SHL boom hoist reeving is 18 part line.
9. Boom backstops are required for all boom lengths.
10. The boom should be erected over the front of the crawlers, not laterally.
11. Ratings inside of boxes are limited by strength of materials.
12. When erecting and lowering the boom length of 102 m or over, the blocks for erection must be placed at the end of the crawlers. (for STD MAST).
13. When erecting and lowering the boom length of 108 m, the blocks for erection must be placed at the end of the crawlers. (for HL MAST).
14. The minimum rated show below.

Minimum Rated Load		
Heavy Duty Crane	Standard Crane	Long Crane
-	7.7 ton	6.2 ton

15. (Main Boom Lifting)

The total load that can be lifted is the value for weight of hook block, slings, and all other load handling accessories deducted from main boom rating shown.

16. (Main Boom Lifting with Auxiliary Sheave Frame)

The total load that can be lifted is weight of auxiliary sheave frame, hook block(s), slings, and all other load handling accessories deducted from main boom ratings shown.

Deduction auxiliary sheave frame		
Heavy Duty Crane	Standard Crane	Long Crane
0.7 ton	0.7 ton	0.7 ton

17. (Auxiliary Sheave Lifting)

The total load that can be lifted is weight of auxiliary sheave frame, hook block(s), slings, and all other load handling accessories deducted from main boom ratings shown.

Deduction auxiliary sheave frame		
Heavy Duty Crane	Standard Crane	Long Crane
0.7 ton	0.7 ton	0.7 ton

18. Ratings shown, but it should not exceed 14.0 ton in case of one reeve, and it should not exceed 28.0 ton in case of two reeve.
19. Auxiliary sheave ratings at any radius from center of rotation are the same as crane ratings shown in table for main boom when operated at the same radius. But maximum angle is the same main boom maximum angle.
20. Boom lengths for auxiliary sheave mounting show below.

	STD	HL	SHL
Heavy Crane	NONE	NONE	NONE

	STD	HL	SHL
STD Crane	30 m ~ 84 m	36 m ~ 84 m	36 m ~ 84 m

	STD	HL	SHL
Long Crane	90 m ~ 102 m	90 m ~ 108 m	90 m ~ 120 m

21. Maximum hoist load for number of reeving parts of line for hoist rope.

Main Hoist Loads (Single Drum)

No. of Parts of Line	1	2	3	4	5
Maximum Loads (t)	14.0	28.0	42.0	56.0	70.0
No. of Parts of Line	6	7	8	9	10
Maximum Loads (t)	84.0	98.0	112.0	126.0	140.0
No. of Parts of Line	11	12	13	14	15
Maximum Loads (t)	152.0	164.0	174.0	184.0	192.0
No. of Parts of Line	16				
Maximum Loads (t)	200.0				

Main Hoist Loads for Heavy Boom (Double Drum)

No. of Parts of Line	8	12	16	20	24	28
Maximum Loads (t)	112.0	164.0	220.0	280.0	336.0	370.0
No. of Parts of Line	36	44				
Maximum Loads (t)	450.0	550.0				

Main Hoist Loads for Standard Boom (Double Drum)

No. of Parts of Line	8	12	16	20	24
Maximum Loads (t)	112.0	164.0	220.0	280.0	300.0

Auxiliary Hoist Loads

No. of Parts of Line	1	2
Maximum Loads (tons)	14.0	28.0

22. Weight of hook block

Weight of hook block				
Hook block	550/450 ton	300 ton (with hanger sheave)	200 ton (w/o hanger sheave)	120 ton
Weight (t)	11.7	9.9 (*1)	7.1 (*2)	4.5

Weight of hook block			
Hook block	70 ton	40 ton	14 ton Ball hook
Weight (t)	3.1	2.0	0.9

*1: 6.82 ton: when hanger sheave is not equipped.

*2: To reeve 11 parts of line or over, the hanger sheave (2 ton) is required.

Operation of this equipment in excess of rated loads or disregard of instruction voids the warranty.

HEAVY FIXED JIB SUPPLEMENTAL DATA

1. Designed and rated to comply with EN13000.
2. Rated loads included in the charts are the maximum allowable freely suspended loads at a given boom length, boom angle and load radius, and have been determined for the machine standing level on firm supporting surface under ideal operating conditions. The user must limit or de-rate rated loads to allow for adverse conditions (such as soft or uneven ground, out-of-level conditions, wind, side loads, pendulum action, jerking or sudden stopping of loads, inexperience of personnel, multiple machine lifts, and traveling with a load).
3. Rated loads do not exceed 75% of minimum tipping loads. Ratings inside of boxes are limited by strength of material or other factor except machine stability.
4. The machine must be reeved and set-up as stated in the operation manual and all the instruction manuals. If these manuals are missing, obtain replacements.
 - Boom backstops are required for all boom lengths.
 - The crane must be leveled to within 1% on a firm supporting surface.
5. Do not attempt to lift where no radius on load is listed as crane may tip or collapse.
6. Attempting to lift more than rated loads may cause machine to tip or collapse. Do not tip machine to determine rated loads.
7. Weight of hooks, hook blocks, slings and other lifting devices are a part of the total load. Their total weight must be subtracted from the rated load to obtain the weight that can be lifted.

8. Configuration

Symbol	Counterweight	Carbody Weight	HL Mast Radius	Pallet Weight
A	200 t	50 t	NONE	NONE
B1	200 t	50 t	11 m	NONE
B2	200 t	50 t	11 m	10 t
C	200 t	50 t	11 m	130 t

9. Boom and Heavy Fixed Jib combinations

Boom	Jib	Type of configuration			
		A	B1	B2	C
66 m	18 m	Y	Y	Y	N
72 m	18 m	Y	Y	Y	
78 m	18 m	Y	Y	Y	
84 m	18 m	N			Y
90 m	18 m				Y
96 m	18 m				Y
102 m	18 m				Y

Y: Applicable boom and heavy fixed jib combination
 N: Not applicable boom and heavy fixed jib combination

10. The boom should erected lowered over the front of the crawlers

Boom	Jib	Type of configuration			
		A	B1	B2	C
66 m	18 m	N	N	N	/
72 m	18 m	N	N	N	
78 m	18 m	Y	N	N	
84 m	18 m	/			N
90 m	18 m				N
96 m	18 m				N
102 m	18 m				N

Y: the blocks must be placed at the end of the crawlers for erection and lowering.

N: the blocks is not needed for erection and lowering.

11. To prevent the boom from leaning toward backward, the own weight of hook block attached to heavy fixed jib point must be equal to or more than 4.5 t.
12. Maximum hoist load for number of reeving parts of line for hoist rope.

Main Boom Hoist Loads (Double Drum)

No. of Parts of Line	8(2x4)	10(2x5)
Maximum Loads (kN)	1,098	1,177
Maximum Loads (t)	112.0	120.0

Main Boom Hoist Loads (Single Drum)

No. of Parts of Line	1	2	3	4	5
Maximum Loads (kN)	137	275	412	549	686
Maximum Loads (t)	14.0	28.0	42.0	50.0	70.0

No. of Parts of Line	6	7	8
Maximum Loads (kN)	824	961	1,098
Maximum Loads (t)	84.0	98.0	112.0

13. Rated loads listed apply only to the machine as originally manufactured and designed by KOBELCO CRANES CO.,LTD. Modifications to this machine or use of equipment other than that specified can reduce operating capacity.

Operation of this equipment in excess of rated loads or disregard of instruction voids the warranty.



Lined writing area consisting of 25 horizontal lines.



LUFFING JIB SUPPLEMENTAL DATA

1. Designed and rated to comply with EN13000.
2. Operating radius is the horizontal distance from centerline of rotation to a vertical line through the center of gravity of the load.
3. Deduct weight of hook blocks, slings and all other load handling accessories from luffing jib ratings shown.
4. Ratings shown are based on freely suspended loads and make no allowance for such factors as wind effect on lifted load, ground conditions, out-of-level operating speeds or any other condition that could be detrimental to the safe operation of this equipment. The operator, therefore, has the responsibility to judge the existing conditions and reduce lifted load and operating speeds accordingly.
5. Ratings are for operation on a firm and level surface, up to 1 % gradient.
6. At radii and boom lengths where no ratings are shown on chart, operation is not intended nor approved.
7. Boom and jib inserts and guy lines must be arranged as shown in the "OPERATOR'S MANUAL".
8. Boom hoist reeving is 30 part line.
HL/SHL boom hoist reeving is 18 part line.
Jib hoist reeving is 18 part line.
9. Boom and jib backstops are required for all boom lengths.
10. The boom should be erected over the front of crawlers, not laterally.
11. Ratings inside of boxes are limited by strength of materials.
12. When erecting and lowering the boom length of 54 m or over, the blocks for erection must be placed at the end of the crawlers. (for STD MAST).
13. The minimum rated load is 4.0 ton.
14. **(Luffing Jib Rating Loads)**
The total load that can be lifted is the value for weight of hook block, slings, and all other loads handling accessories deducted from luffing jib ratings shown.
15. **(Luffing Jib Lifting with Auxiliary Sheave Frame)**
The total load that can be lifted is the weight of hook block, slings, and all other loads handling accessories deducted from luffing jib ratings shown.
16. **(Auxiliary Sheave Lifting)**
The total load that can be lifted over an auxiliary sheave is weight of hook block, slings, and all other loads handling accessories deducted from luffing jib ratings shown, but it should not exceed 14.0 ton in case of one reeve.
It should not exceed 28.0 ton in case of two reeves.
Boom and jib combinations for auxiliary sheave mounting are all boom and jib combinations.
Auxiliary sheave ratings at any radius from center of rotation are the same as luffing ratings shown in table for jib when operated at the same radius.
But maximum angle is the same jib maximum angle.
17. Luffing boom and jib combinations.

		Jib Length										
		24 m (79 ft)	30 m (98 ft)	36 m (118 ft)	42 m (138 ft)	48 m (157 ft)	54 m (177 ft)	60 m (197 ft)	66 m (217 ft)	72 m (236 ft)	78 m (256 ft)	84 m (276 ft)
Boom Length	30 m (98 ft)	○*	○*	○*	○*	○*	○*	○*	○*	○*	×	×
	36 m (118 ft)	○	○	○	○	○	○	○	○	○	○**	○**
	42 m (138 ft)	○	○	○	○	○	○	○	○	○	○**	○**
	48 m (157 ft)	○	○	○	○	○	○	○	○	○	○**	○**
	54 m (177 ft)	○	○	○	○	○	○	○	○	○	○**	○**
	60 m (197 ft)	○	○	○	○	○	○	○	○	○	○**	○**
	66 m (217 ft)	○***	○***	○***	○***	○***	○***	○***	○***	○***	○**	○**
	72 m (236 ft)	○**	○**	○**	○**	○**	○**	○**	○**	○**	○**	○**
	78 m (256 ft)	×	○**	○**	○**	○**	○**	○**	○**	○**	○**	○**
	84 m (276 ft)	×	○**	○**	○**	○**	○**	○**	○**	○**	○**	○**

- × : All luffing jib combinations which is not allowed.
- : All luffing jib combinations which is allowed.
- * : Standard-luffing jib combinations which is allowed.
- ** : Super heavy lift-Luffing jib combinations which is allowed.
- *** : Heavy lift and Super heavy lift-Luffing jib combinations which is allowed.

18. Maximum hoist load for number of reeving parts of line for hoist rope.

Jib Hook Loads (Single Drum)

No. of Parts of Line	1	2	3	4	5
Maximum Loads (t)	14.0	28.0	42.0	56.0	70.0

No. of Parts of Line	6	7	8	9	10
Maximum Loads (t)	84.0	98.0	112.0	126.0	140.0

No. of Parts of Line	11	12	13	14	15
Maximum Loads (t)	152.0	164.0	174.0	184.0	192.0

No. of Parts of Line	16
Maximum Loads (t)	200.0

Jib Hook (Double Drum)

No. of Parts of Line	8	12	16
Maximum Loads (t)	112.0	164.0	200.0

Auxiliary Sheave

No. of Parts of Line	1	2
Maximum Loads (t)	14.0	28.0

Weight of hook block					
Hook block	200 ton	120 ton	70 ton	40 ton	14 ton Ball Hook
Weight (t)	7.05	4.5	3.1	2.0	0.9

21. Hook block and number of reeving parts of line restriction

- (1) The self-weight of luffing jib point hook block must be heavier than or equal to the table below.
- (2) Total number of reeving parts of line on luffing jib point hook block must be larger than or equal to the table below.

Danger!

Follow the both (1) and (2) above at a same time for the luffing jib operation. Otherwise luffing jib may tip over the backwards due to lack of weight on front side of boom. Failure to observe this precaution may lead to the jib tipping backwards and resulted to machine collapsing.

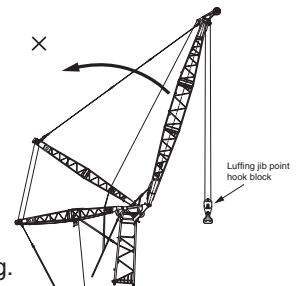

SL6000 minimum hook block self-weight and minimum number of reeving parts of line on hook block

Boom Length	Jib Length	24 m	30 m	36 m	42 m	48 m	54 m	60 m	66 m	72 m	78 m	84 m
		(79 ft)	(98 ft)	(118 ft)	(138 ft)	(157 ft)	(177 ft)	(197 ft)	(217 ft)	(236 ft)	(256 ft)	(276 ft)
30 m (98 ft)	Hook Block Self-Weight (kg)	7,050	4,500	3,100	2,000	2,000	2,000	2,000	2,000	2,000	2,000	2,000
	No. of Part Line	13	6	4	2	2	2	2	2	2	2	2
36 m (118 ft)	Hook Block Self-Weight (kg)	7,050	4,500	3,100	2,000	2,000	2,000	2,000	2,000	2,000	2,000	2,000
	No. of Part Line	11	6	4	2	2	2	2	2	2	2	2
42 m (138 ft)	Hook Block Self-Weight (kg)	7,050	7,050	3,100	2,000	2,000	2,000	2,000	2,000	2,000	2,000	2,000
	No. of Part Line	10	9	4	2	2	2	2	2	2	2	2
48 m (157 ft)	Hook Block Self-Weight (kg)	7,050	7,050	3,100	2,000	2,000	2,000	2,000	2,000	2,000	2,000	2,000
	No. of Part Line	9	9	4	2	2	2	2	2	2	2	2
54 m (177 ft)	Hook Block Self-Weight (kg)	7,050	7,050	4,500	3,100	2,000	2,000	2,000	2,000	2,000	2,000	2,000
	No. of Part Line	9	8	6	2	2	2	2	2	2	2	2
60 m (197 ft)	Hook Block Self-Weight (kg)	7,050	7,050	7,050	3,100	2,000	2,000	2,000	2,000	2,000	2,000	2,000
	No. of Part Line	8	7	7	3	2	2	2	2	2	2	2
66 m (217 ft)	Hook Block Self-Weight (kg)	7,050	7,050	7,050	4,500	3,100	2,000	2,000	2,000	2,000	2,000	2,000
	No. of Part Line	7	7	6	2	2	2	2	2	2	2	2
72 m (236 ft)	Hook Block Self-Weight (kg)	7,050	7,050	7,050	4,500	3,100	2,000	2,000	2,000	2,000	2,000	2,000
	No. of Part Line	7	6	6	2	2	2	2	2	2	2	2
78 m (256 ft)	Hook Block Self-Weight (kg)		7,050	7,050	4,500	3,100	2,000	2,000	2,000	2,000	2,000	2,000
	No. of Part Line		6	5	2	2	2	2	2	2	2	2
84 m (276 ft)	Hook Block Self-Weight (kg)		7,050	7,050	4,500	3,100	2,000	2,000	2,000	2,000	2,000	2,000
	No. of Part Line		5	5	3	2	2	2	2	2	2	2

Weight of KOBELCO genuine hook block.

200 t hook block	7,050 kg	70 t hook block	3,100 kg
120 t hook block	4,500 kg	40 t hook block	2,000 kg

19. Lifting capacities listed apply only to the machine as originally manufactured and designed by KOBELCO CRANES CO.,LTD. Modifications to this machine or use of equipment other than that specified can reduce operating capacity.

20. Designed and rated to comply with ASME Code B30.5.

Operation of this equipment in excess of rated loads or disregard of instruction voids the warranty.



LIFTING CAPACITIES

Heavy Duty Crane Boom Lifting Capacities

Unit: ton

Counterweight: 180.0 ton, Carbody weight: 50.0 ton

Working Radius (m)	Boom Length (m)				Working Radius (m)
	24.0	30.0	36.0	42.0	
6.0	6.7 m/450.0				6.0
7.0	425.0	7.5 m/390.0			7.0
8.0	375.0	365.0	8.3 m/340.0		8.0
9.0	330.0	325.0	322.0	9.2 m/311.7	9.0
10.0	294.0	292.0	290.0	280.1	10.0
12.0	233.3	232.8	232.1	225.0	12.0
14.0	192.0	191.5	190.7	187.0	14.0
16.0	158.7	158.8	158.9	158.6	16.0
18.0	133.3	133.3	133.4	133.1	18.0
20.0	114.4	114.4	114.3	114.0	20.0
22.0	97.4	97.3	97.2	97.1	22.0
24.0		87.0	86.9	86.4	24.0
26.0		78.5	78.3	77.8	26.0
28.0		70.7	70.4	69.8	28.0
30.0		28.6 m/68.5	63.7	63.1	30.0
34.0			33.8 m/53.5	52.4	34.0
38.0				44.4	38.0
42.0				39.0 m/42.6	42.0
Reeves	36	36	28	24	Reeves

Note:

Designed and rated to comply with EN13000 .

Ratings shown in are determined by the strength of the boom or other structural components.

Long Boom Lifting Capacities

Unit: ton

Counterweight: 180.0 ton, Carbody weight: 50.0 ton

Working Radius (m)	Boom Length (m)					Working Radius (m)
	90.0	96.0	102.0	108.0	114.0	
14.0	15.0 m/98.0	15.8 m/84.0				14.0
16.0	96.0	83.7	16.6 m/70.0	17.5m /60.0		16.0
18.0	93.0	81.1	68.5	58.8		18.0
20.0	90.0	78.5	66.3	55.1		20.0
22.0	81.1	76.0	64.2	51.4		22.0
24.0	72.6	70.8	62.1	48.4		24.0
26.0	64.9	64.2	60.0	45.4		26.0
28.0	58.4	58.3	57.3	42.9		28.0
30.0	52.9	52.8	51.3	40.4		30.0
34.0	44.1	43.3	42.1	36.7		34.0
38.0	37.0	35.8	35.1	33.2		38.0
42.0	31.0	30.2	29.7	28.6		42.0
46.0	26.0	25.4	24.9	22.6		46.0
50.0	21.8	21.3	20.8	17.3		50.0
54.0	18.1	17.6	17.1	12.7		54.0
58.0	14.8	14.4	14.0	8.7		58.0
62.0	12.0	11.6	11.1	60.0m /6.8		62.0
66.0	9.5	9.0	8.5			66.0
70.0	7.2	6.7	6.2			70.0
72.0	6.2					72.0
Reeves	7	6	5	5		Reeves

Note:

Designed and rated to comply with EN13000 .

Ratings shown in are determined by the strength of the boom or other structural components.

Heavy Fixed Jib (Type A) Lifting Capacities

Unit: ton

Counterweight: 200.0 ton
Carbody weight: 50.0 ton

Working Radius (m)	Jib Length (m)			Working Radius (m)
	66.0	72.0	78.0	
20.0	105.0	100.0	95.0	20.0
22.0	98.1	94.7	91.2	22.0
24.0	88.1	85.0	81.9	24.0
26.0	79.6	76.7	73.8	26.0
28.0	71.1	69.5	66.8	28.0
30.0	63.6	62.3	60.6	30.0
34.0	51.5	50.1	48.6	34.0
38.0	42.0	40.6	39.1	38.0
42.0	34.4	33.0	31.5	42.0
46.0	28.2	26.8	25.3	46.0
50.0	23.1	21.7	20.1	50.0
54.0	18.7	17.3	15.7	54.0
58.0	14.9	13.5	11.9	58.0
62.0	11.6	10.3	8.7	62.0
Reeves	8	8	8	Reeves

Note:

Designed and rated to comply with EN13000 .

Ratings shown in are determined by the strength of the boom or other structural components.



Luffing Boom Lifting Capacities

Unit: ton

Counterweight: 180.0 ton, Carbody weight: 50.0 ton

Working Radius (m) \ Boom Length (m)	30.0	36.0	42.0	48.0	54.0	60.0	66.0	72.0	78.0	84.0	Working Radius (m) \ Boom Length (m)
7.0	7.7 m/300.0										7.0
8.0	300.0	8.5 m/300.0									8.0
9.0	300.0	300.0	9.3 m/300.0								9.0
10.0	292.1	291.4	278.2	10.2 m/258.6	11.0 m/224.6	11.8 m/197.3					10.0
12.0	230.2	229.5	222.9	212.7	203.2	194.3	12.7 m/175.1	13.5 m/156.1			12.0
14.0	188.9	188.2	184.8	177.0	169.8	163.0	156.5	149.9	14.3 m/140.3	15.2 m/126.4	14.0
16.0	157.8	157.6	156.9	150.7	145.0	139.4	134.1	128.6	123.8	119.0	16.0
18.0	132.4	132.1	131.4	130.5	125.7	121.0	116.5	111.9	107.8	103.6	18.0
20.0	113.4	113.0	112.3	111.8	110.3	106.2	102.4	98.3	94.7	91.1	20.0
22.0	98.6	98.3	97.5	96.9	96.4	94.2	90.7	87.0	83.9	80.6	22.0
24.0	86.9	86.5	85.7	85.1	84.6	83.9	81.0	77.6	74.8	71.8	24.0
26.0	77.3	76.9	76.1	75.5	74.9	74.2	72.7	69.6	67.0	64.2	26.0
28.0	69.4	68.9	68.1	67.4	66.8	66.1	65.4	62.7	60.3	57.7	28.0
30.0	28.7 m/66.8	62.2	61.4	60.7	60.1	59.3	58.6	56.7	54.4	52.0	30.0
34.0		33.9 m/51.7	50.7	49.9	49.3	48.4	47.7	46.7	44.7	42.4	34.0
38.0			42.6	41.8	41.0	40.2	39.4	38.4	37.0	34.9	38.0
42.0			39.1 m/40.7	35.4	34.6	33.7	32.7	31.4	30.4	28.7	42.0
46.0				44.3 m/32.3	29.5	28.3	27.2	25.9	24.8	23.6	46.0
50.0					49.5 m/25.7	23.8	22.6	21.3	20.2	19.0	50.0
54.0						20.6	18.9	17.5	16.4	15.1	54.0
58.0						54.7 m/19.6	15.7	14.3	13.1	11.9	58.0
62.0							59.9 m/14.4	11.6	10.3	8.8	62.0
66.0								65.1 m/9.7	7.6		66.0
Reeves	24	24	24	20	20	16	16	12	12	12	Reeves

Note:

Designed and rated to comply with EN13000.

Ratings shown in are determined by the strength of the boom or other structural components.

Ratings enclosed in gray-color box in the table require double-drum specifications.



LIFTING CAPACITIES

Luffing Jib Lifting Capacity

Unit: ton

Counterweight: 180.0 ton, Carbody weight: 50.0 ton

30.0 m Boom Length	Boom length (m)	30.0															Boom length (m)
	Jib length (m)	24.0			42.0			54.0			66.0			72.0			Jib length (m)
	Boom angle	86°	76°	66°	86°	76°	66°	86°	76°	66°	86°	76°	66°	86°	76°	66°	Boom angle
Working Radius (m)	14.0	184.0															14.0
	15.0	173.5															15.0
	16.0	160.5															16.0
	17.0	151.0															17.0
	18.0	141.6															18.0
	20.0	125.3			111.6												20.0
	22.0	112.2			107.1												22.0
	24.0	100.1	93.7		97.9			85.2									24.0
	26.0	89.8	84.2		89.3			85.2									26.0
	28.0	81.3	76.2		80.9			78.9			67.3						28.0
	30.0		69.5		73.8			73.1			67.3			60.2			30.0
	34.0		58.8	54.9	62.5	57.7		61.9			60.4			58.7			34.0
	38.0			47.3	54.0	49.7		53.3	48.8		52.2			51.8			38.0
	42.0				47.2	43.5		46.6	42.6		45.5			45.1			42.0
	46.0				41.8	38.4	35.1	41.2	37.5		40.1	36.2		39.4	35.0		46.0
	50.0					34.3	31.3	36.7	33.4	30.2	34.6	31.9		33.0	30.7		50.0
	54.0						28.1	32.7	29.9	27.0	29.5	28.3		27.8	27.1		54.0
	58.0							28.5	27.0	24.2	25.2	25.2	21.9	23.5	24.1		58.0
	62.0								24.5	21.9	21.6	22.6	19.5	19.8	21.5	18.3	62.0
	66.0									19.9	18.6	20.5	17.5	16.7	19.3	16.3	66.0
	70.0										16.1	18.6	15.8	14.1	17.4	14.5	70.0
	74.0											17.1	14.3	11.9	15.8	13.0	74.0
	78.0												13.0		14.4	11.7	78.0
	82.0															10.6	82.0
	86.0															9.8	86.0
	Reeves		16			8			8			8			8		Reeves

36.0 m Boom Length	Boom length (m)	36.0															Boom length (m)
	Jib length (m)	24.0			42.0			54.0			66.0			72.0			Jib length (m)
	Boom angle	86°	76°	66°	86°	76°	66°	86°	76°	66°	86°	76°	66°	86°	76°	66°	Boom angle
Working Radius (m)	15.0	167.8															15.0
	16.0	157.0															16.0
	17.0	148.2															17.0
	18.0	139.4															18.0
	20.0	124.3			111.0												20.0
	22.0	111.3			103.7												22.0
	24.0	99.8			95.0			84.7									24.0
	26.0	89.6	82.5		87.6			82.7									26.0
	28.0	81.1	74.7		80.7			76.6			66.8						28.0
	30.0	73.8	68.1		73.6			71.3			66.8			59.7			30.0
	34.0		57.6		62.4	56.4		61.5			58.7			57.0			34.0
	38.0			45.4	53.8	48.6		53.0			51.9			50.3			38.0
	42.0			39.6	47.1	42.5		46.3	41.4		45.2			44.9			42.0
	46.0				41.7	37.5	33.5	40.9	36.4		39.8	34.8		39.2			46.0
	50.0					33.4	29.8	36.5	32.4		34.4	30.5		32.8	29.4		50.0
	54.0						26.7	32.4	29.0	25.1	29.2	27.0		27.5	25.8		54.0
	58.0						24.0	28.1	26.1	22.4	24.9	24.0		23.1	22.9		58.0
	62.0								23.7	20.1	21.2	21.5	17.7	19.4	20.3		62.0
	66.0									18.1	18.1	19.4	15.8	16.3	18.2	14.5	66.0
	70.0									16.3	15.5	17.5	14.1	13.6	16.3	12.8	70.0
	74.0											16.0	12.7	11.3	14.7	11.4	74.0
	78.0												11.3		13.4	10.1	78.0
	82.0												10.1		11.4	9.1	82.0
	86.0															8.2	86.0
	Reeves		16			8			8			8			8		Reeves

Note: Designed and rated to comply with EN13000.

Ratings shown in are determined by the strength of the boom or other structural components.

Ratings enclosed in gray-color box in the table require double-drum specifications.



Luffing Jib Lifting Capacity

Unit: ton

Counterweight: 180.0 ton, Carbody weight: 50.0 ton

42.0 m Boom Length	Boom length (m)	42.0															Boom length (m)
	Jib length (m)	24.0			42.0			54.0			66.0			72.0			Jib length (m)
	Boom angle	86°	76°	66°	86°	76°	66°	86°	76°	66°	86°	76°	66°	86°	76°	66°	Boom angle
15.0	15.4 m/156.2																15.0
16.0	151.0																16.0
17.0	142.7																17.0
18.0	134.4																18.0
20.0	121.0																20.0
22.0	110.0				96.6												22.0
24.0	99.3				92.1			84.1									24.0
26.0	89.1				85.0			80.2									26.0
28.0	80.6	72.9			78.8			74.4				66.3					28.0
30.0	73.4	66.4			73.4			69.2				65.1			59.2		30.0
34.0		56.2			62.2			60.7				57.0			55.3		34.0
38.0		48.3	43.1		53.7	47.4		52.7				50.4			48.9		38.0
42.0			37.6		47.0	41.4		46.0	40.1			44.9			43.5		42.0
46.0					41.6	36.5		40.6	35.2			39.5	33.2		38.7		46.0
50.0						32.5	27.8	36.2	31.3			34.0	29.1		32.4	27.9	50.0
54.0						29.2	24.8	32.0	27.9			28.8	25.6		27.1	24.5	54.0
58.0							22.2	27.7	25.0	20.1		24.4	22.7		22.7	21.6	58.0
62.0							19.9		22.6	17.9	20.8	20.3	15.8		19.0	19.1	62.0
66.0									20.6	16.0	17.6	18.2	13.9	15.8	17.0	12.6	66.0
70.0										14.3	15.0	16.4	12.3	13.1	15.1	11.0	70.0
74.0										12.9		14.9	10.8	10.8	13.6	9.6	74.0
78.0												13.6	9.5		12.3	8.4	78.0
82.0													8.4		11.2	7.4	82.0
86.0																6.6	86.0
90.0																5.7	90.0
Reeves		12			8			8			8			8			Reeves

48.0 m Boom Length	Boom length (m)	48.0															Boom length (m)
	Jib length (m)	24.0			42.0			54.0			66.0			72.0			Jib length (m)
	Boom angle	86°	76°	66°	86°	76°	66°	86°	76°	66°	86°	76°	66°	86°	76°	66°	Boom angle
16.0	16.2 m/143.5																16.0
17.0	137.4																17.0
18.0	129.6																18.0
20.0	116.9																20.0
22.0	106.4				96.0												22.0
24.0	97.7				89.1			82.4									24.0
26.0	88.8				82.3			77.6									26.0
28.0	80.3	71.1			76.4			72.0				65.7					28.0
30.0	73.2	64.8			71.2			67.1				63.0			58.6		30.0
34.0		54.7			61.8			58.9				55.2			53.5		34.0
38.0		47.1			53.3	45.9		51.9				48.8			47.3		38.0
42.0			35.2		46.6	40.0		45.4	38.6			43.6			42.2		42.0
46.0			30.9		41.2	35.3		40.2	33.9			39.2			37.9		46.0
50.0						31.4	25.0	35.9	29.9			33.5	27.6		31.9	26.3	50.0
54.0						28.1	22.2	31.4	26.5			28.3	24.2		26.6	23.0	54.0
58.0							19.7	27.1	23.7	17.6		23.9	21.4		22.2	20.1	58.0
62.0							17.6		21.2	15.6	20.2	19.0			18.4	17.8	62.0
66.0									19.1	13.8	17.1	16.9	11.7		15.2	15.7	66.0
70.0										12.2	14.4	15.2	10.1	12.5	13.9	9.1	70.0
74.0										10.9		13.7	8.8	10.2	12.4	7.8	74.0
78.0												12.3	7.6		11.1	6.7	78.0
82.0													6.5		10.1		82.0
Reeves		12			8			8			8			8			Reeves

Note: Designed and rated to comply with EN13000.

Ratings shown in are determined by the strength of the boom or other structural components.

Ratings enclosed in gray-color box in the table require double-drum specifications.



BOOM AND JIB ARRANGEMENTS

Luffing Jib Lifting Capacity

Unit: ton

Counterweight: 180.0 ton, Carbody weight: 50.0 ton

54.0 m Boom Length	Boom length (m)	54.0															Boom length (m)
	Jib length (m)	24.0			42.0			54.0			66.0			72.0			Jib length (m)
	Boom angle	86°	76°	66°	86°	76°	66°	86°	76°	66°	86°	76°	66°	86°	76°	66°	Boom angle
Working Radius (m)	17.0	132.2															17.0
	18.0	124.8															18.0
	20.0	112.8															20.0
	22.0	102.8			93.7												22.0
	24.0	94.5			86.1												24.0
	26.0	87.3			79.6		74.0										26.0
	28.0	80.0			74.0		69.7			64.2							28.0
	30.0	72.8	63.0		69.0		65.0			60.9			58.1				30.0
	34.0		53.2		60.6		57.0			53.4			51.7				34.0
	38.0		45.7		52.9	43.8	50.6			47.2			45.8				38.0
	42.0			32.1	46.2	38.5	45.2			42.2			40.8				42.0
	46.0			28.1	40.9	33.8	39.9	31.9		37.9			36.6				46.0
	50.0					29.9	35.5	28.0		32.7	25.9		31.2				50.0
	54.0					26.7	19.5	30.7	24.8	27.6	22.7		25.9	21.5			54.0
	58.0					23.9	17.2	26.4	22.1	23.2	19.9		21.5	18.7			58.0
	62.0						15.2		19.7	13.1	19.6	17.6		17.8	16.4		62.0
	66.0						13.6		17.7	11.5	16.5	15.6		14.6	14.4		66.0
	70.0									10.0	13.8	13.9		11.9	12.7		70.0
	74.0									8.8		12.4		9.6	11.2		74.0
	78.0									7.7		11.0			9.9		78.0
	82.0														8.9		82.0
	86.0														8.0		86.0
	Reeves		12			8			8			8			8		Reeves

60.0 m Boom Length	Boom length (m)	60.0															Boom length (m)
	Jib length (m)	24.0			42.0			54.0			66.0			72.0			Jib length (m)
	Boom angle	86°	76°	66°	86°	76°	66°	86°	76°	66°	86°	76°	66°	86°	76°	66°	Boom angle
Working Radius (m)	17.0	17.8 m/121.3															17.0
	18.0	120.1															18.0
	20.0	108.7															20.0
	22.0	99.3			90.4												22.0
	24.0	91.3			83.2												24.0
	26.0	84.5			77.0			72.4									26.0
	28.0	78.6			71.5			67.3									28.0
	30.0	72.5			66.7			62.8			58.3						30.0
	34.0		51.3		58.7			55.2			51.5			47.7			34.0
	38.0		44.2		52.3			49.0			45.6			44.2			38.0
	42.0		38.4		45.8	36.1		43.9			40.7			39.4			42.0
	46.0			25.1	40.5	31.6		39.6	29.8		36.6			35.3			46.0
	50.0			22.0		27.9		34.8	26.4		31.7	23.8		30.1			50.0
	54.0					24.8		29.8	23.3		26.7	21.1		25.0	19.4		54.0
	58.0					22.2	14.4	25.6	20.7		22.4	18.4		20.7	17.0		58.0
	62.0						12.7		18.4	10.9	18.8	16.2		17.1	14.8		62.0
	66.0						11.1		16.4	9.4	15.8	14.3		14.0	13.0		66.0
	70.0								14.7	8.0	13.1	12.6		11.3	11.3		70.0
	74.0									6.9		11.2		9.0	9.9		74.0
	78.0											10.0		7.0	8.7		78.0
	82.0											8.8			7.7		82.0
	86.0														6.8		86.0
	Reeves		12			8			8			8			8		Reeves

Note: Designed and rated to comply with EN13000.

Ratings shown in are determined by the strength of the boom or other structural components.

Ratings enclosed in gray-color box in the table require double-drum specifications.

HEAVY LIFT

BOOM AND JIB ARRANGEMENTS

Heavy Duty Crane Boom Arrangements

Boom length m (ft)	Boom arrangement
36 (118)	※
42 (138)	※

Symbol	Boom Length	Remarks
	9.0 m (29.5 ft)	Boom Base
	8.0 m (26.2 ft)	Tapered Boom
	6.0 m (19.7 ft)	Insert Boom
	12.0 m (39.4 ft)	Insert Boom
	1.0 m (3.3 ft)	Boom Top

※ indicates the most flexible combination of insert heavy duty booms, which can be modified to form all shorter heavy duty boom arrangements.

Luffing Boom Arrangements for Crane

Boom length m (ft)	Boom arrangement
36 (118)	※
42 (138)	※
48 (157)	※
54 (177)	※
60 (197)	※
66 (217)	※
72 (236)	※
78 (256)	※
84 (276)	※

Symbol	Boom Length	Remarks
	9.0 m (29.5 ft)	Boom Base
	8.0 m (26.2 ft)	Tapered Boom
	6.0 m (19.7 ft)	Insert Boom
	12.0 m (39.4 ft)	Insert Boom
	1.0 m (3.3 ft)	Boom Top

※ indicates the most flexible combination of insert luffing booms, which can be modified to form all shorter luffing boom arrangements.

Long Boom Arrangements

Boom length m (ft)	Boom arrangement
90 (295)	
96 (315)	※
102 (335)	※
108 (354)	※

Symbol	Boom Length	Remarks
	9.0 m (29.5 ft)	Boom Base
	8.0 m (26.2 ft)	Tapered Boom
	6.0 m (19.7 ft)	Insert Boom
	12.0 m (39.4 ft)	Insert Boom
	5.0 m (16.4 ft)	Luffing Insert Jib
	6.0 m (19.7 ft)	Luffing Insert Jib
	12.0 m (39.4 ft)	Luffing Insert Jib
	8.0 m (26.2 ft)	Jib Top

※ indicates the most flexible combination of insert long booms, which can be modified to form all shorter long boom arrangements.

Heavy Fixed Jib Boom Arrangements (Type B1)

Boom length m (ft)	Boom arrangement
66 (217)	※
72 (236)	※
78 (256)	※

Symbol	Boom Length	Remarks
	9.0 m (29.5 ft)	Boom Base
	8.0 m (26.2 ft)	Tapered Boom
	6.0 m (19.7 ft)	Insert Boom
	12.0 m (39.4 ft)	Insert Boom
	1.0 m (3.3 ft)	Boom Top

↗ mark shows the guy line installing position when the fixed jib is used.
 ※ indicates the most flexible combination of insert luffing booms, which can be modified to form all shorter luffing boom arrangements.

Heavy Fixed Jib Arrangements (Type B1)

Jib length m (ft)	Jib arrangement
18 (59)	

Symbol	Jib Length	Remarks
	10.0 m (32.8 ft)	Jib Base
	8.0 m (26.2 ft)	Jib Top

HEAVY LIFT

BOOM AND JIB ARRANGEMENTS

Luffing Boom Arrangements for Luffing

Boom length m (ft)	Boom arrangement
36 (118)	※
42 (138)	※
48 (157)	※
54 (177)	※
60 (197)	※
66 (217)	※

Symbol	Boom Length	Remarks
	9.0 m (29.5 ft)	Boom Base
	8.0 m (26.2 ft)	Tapered Boom
	6.0 m (19.7 ft)	Insert Boom
	12.0 m (39.4 ft)	Insert Boom
	1.0 m (3.3 ft)	Boom Top

※ indicates the most flexible combination of insert luffing booms, which can be modified to form all shorter luffing boom arrangements.

Luffing Jib Arrangements

Jib length m (ft)	Jib arrangement
24 (79)	
30 (98)	※
36 (118)	※
42 (138)	※
48 (157)	※
54 (177)	※
60 (197)	※
66 (217)	※
72 (236)	※

Symbol	Jib Length	Remarks
	10.0 m (32.8 ft)	Jib Base
	6.0 m (19.7 ft)	Luffing Insert Jib
	12.0 m (39.4 ft)	Luffing Insert Jib
	8.0 m (26.2 ft)	Jib Top

※ indicates the most flexible combination of insert luffing jibs, which can be modified to form all shorter luffing jib arrangements.

HL MAST

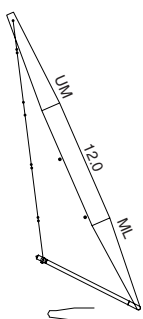

Symbol	Mast Length	Remarks
	9.0 m (29.5 ft)	Mast Base
	12.0 m (39.4 ft)	Insert Mast
	10.0 m (32.8 ft)	Mast Top

WORKING RANGES

Heavy Duty Crane Boom

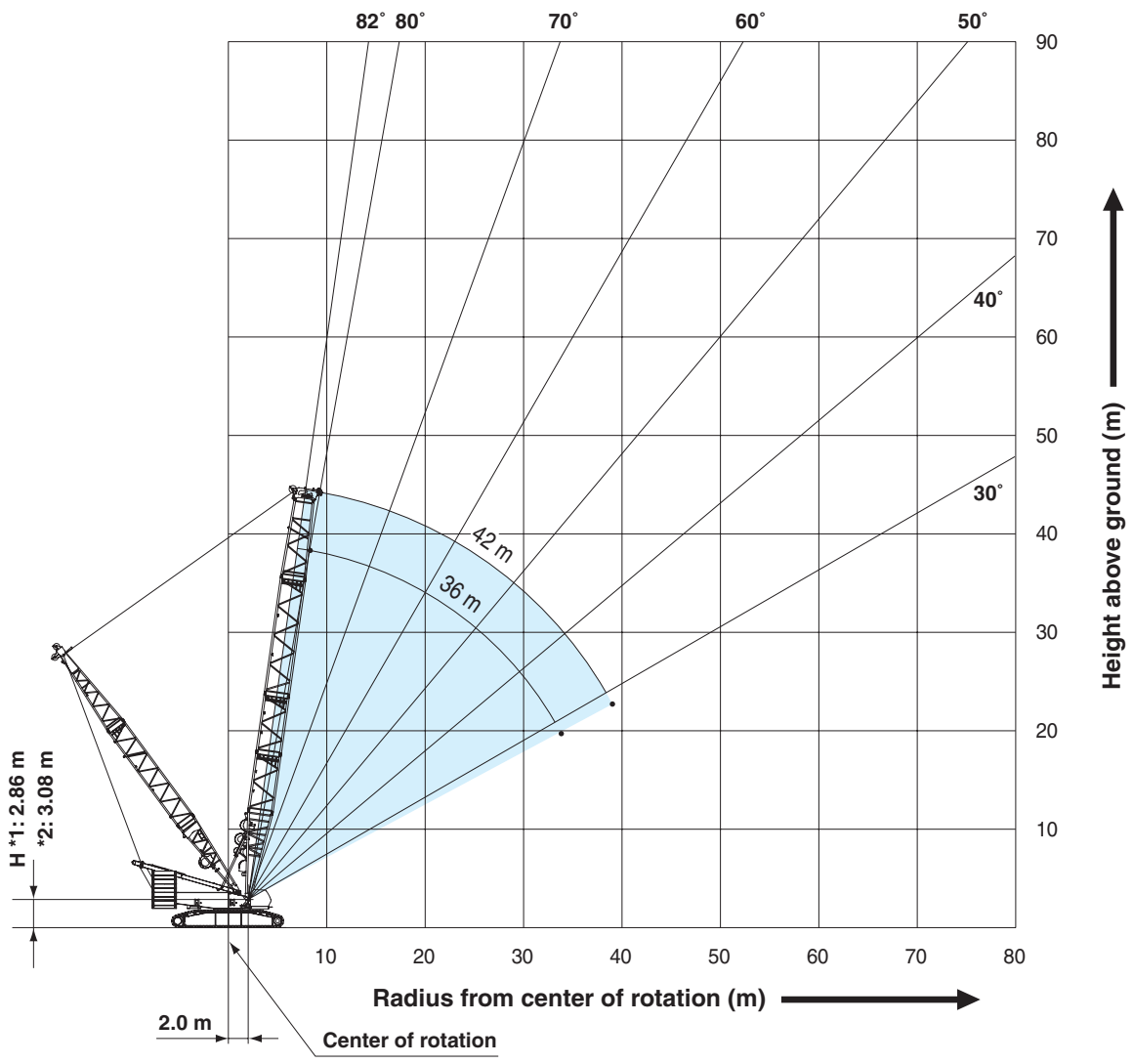

1: Without upper/lower connecting device
2: With upper/lower connecting device

WORKING RANGES

Luffing Boom

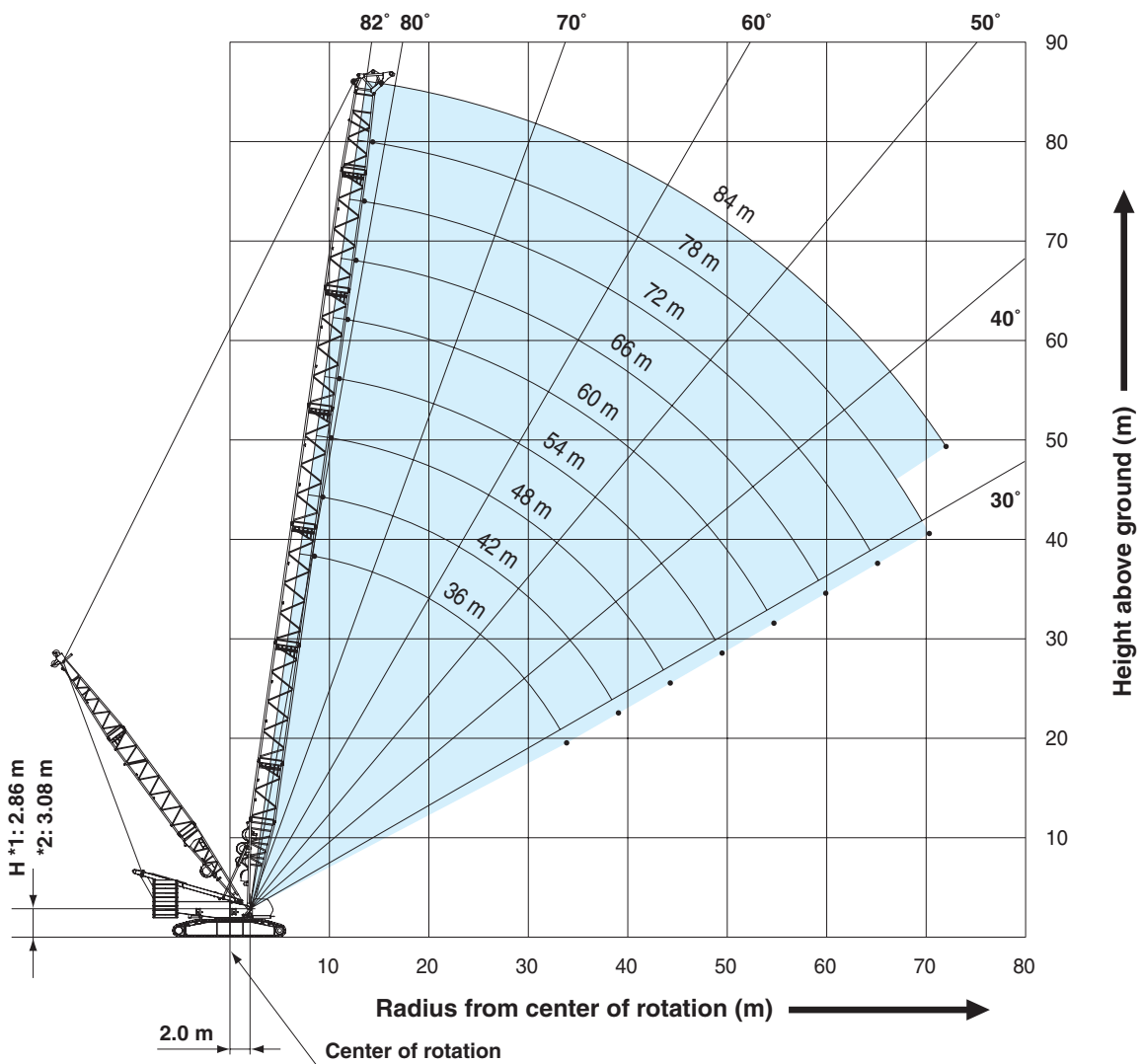

1: Without upper/lower connecting device
 2: With upper/lower connecting device

Long Boom

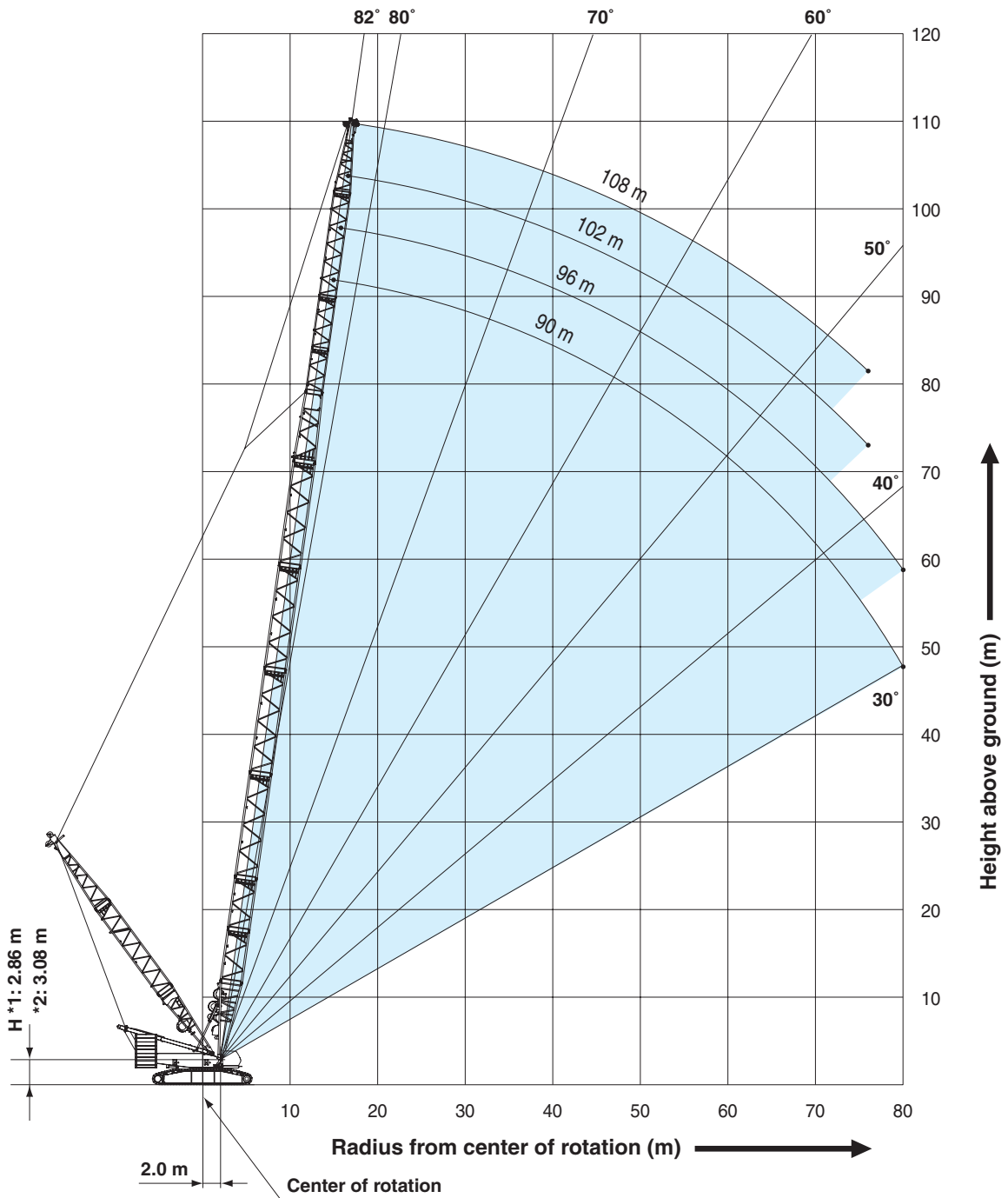

- 1: Without upper/lower connecting device
- 2: With upper/lower connecting device

HEAVY LIFT

WORKING RANGES

Heavy Fixed Jib (Type B1)

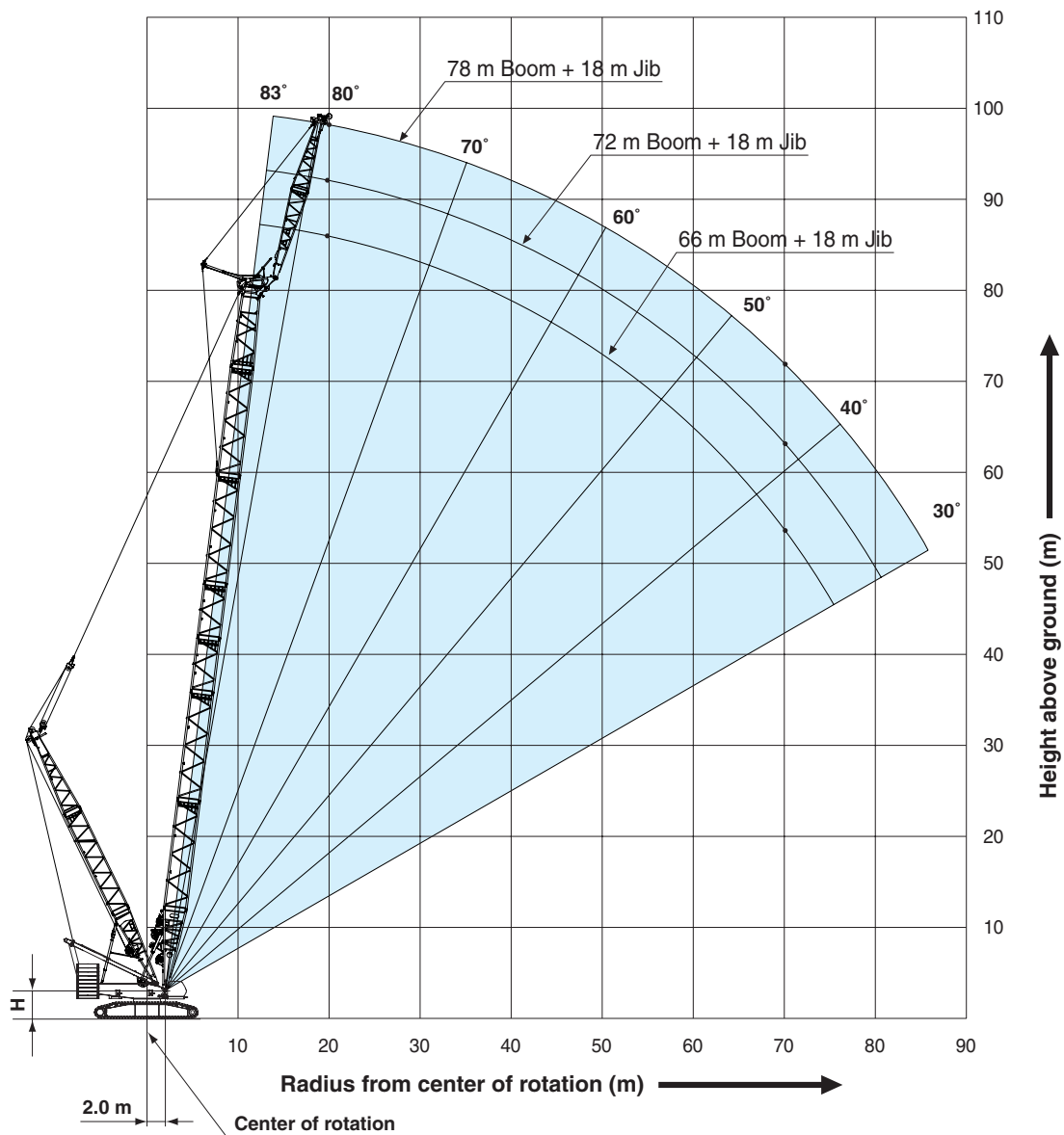

H=2.86 m Without quick connection ring
H=3.08 m With quick connection ring

Luffing Jib

Boom Angle: 86°

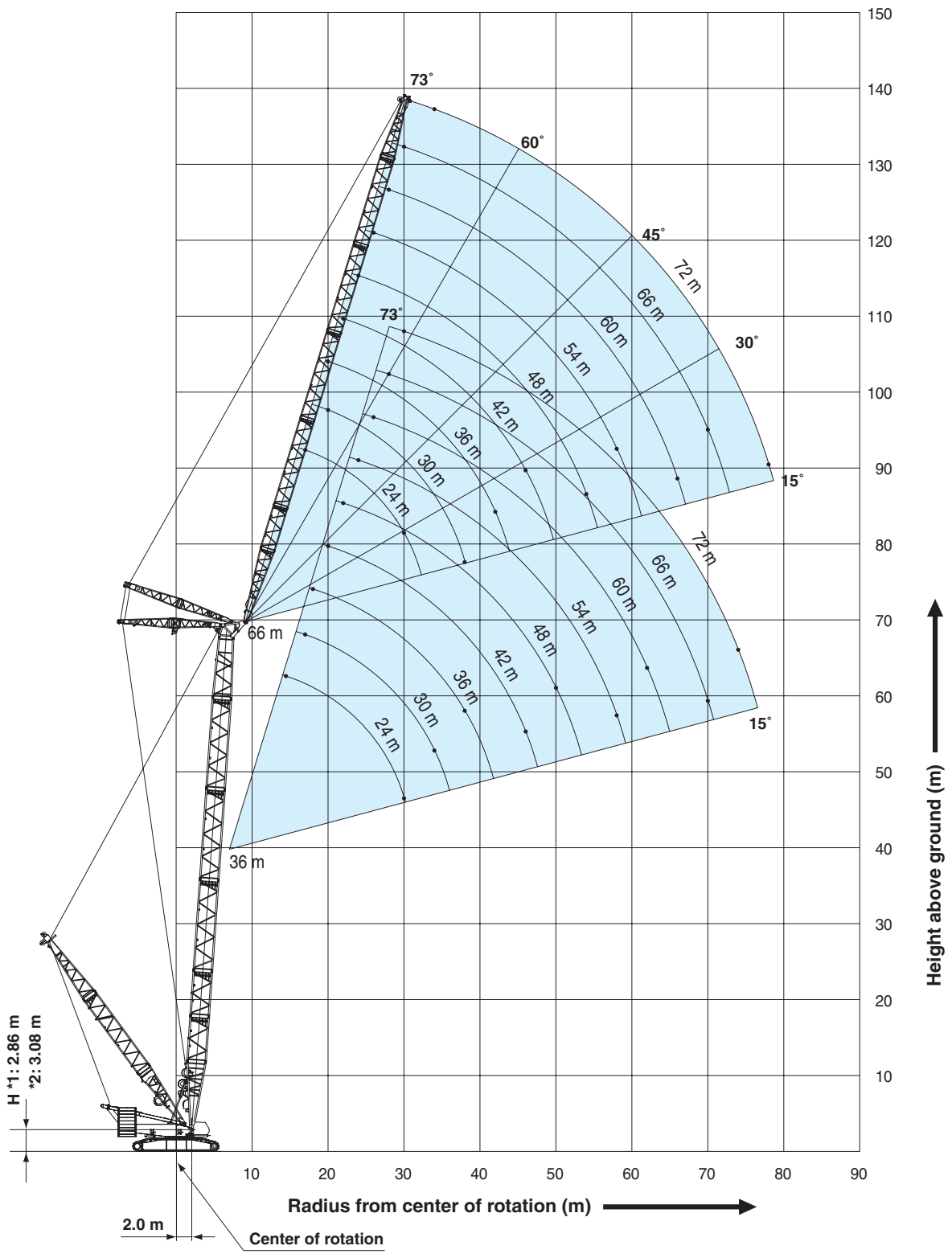

1: Without upper/lower connecting device
2: With upper/lower connecting device

WORKING RANGES

Luffing Jib

Boom Angle: 76°

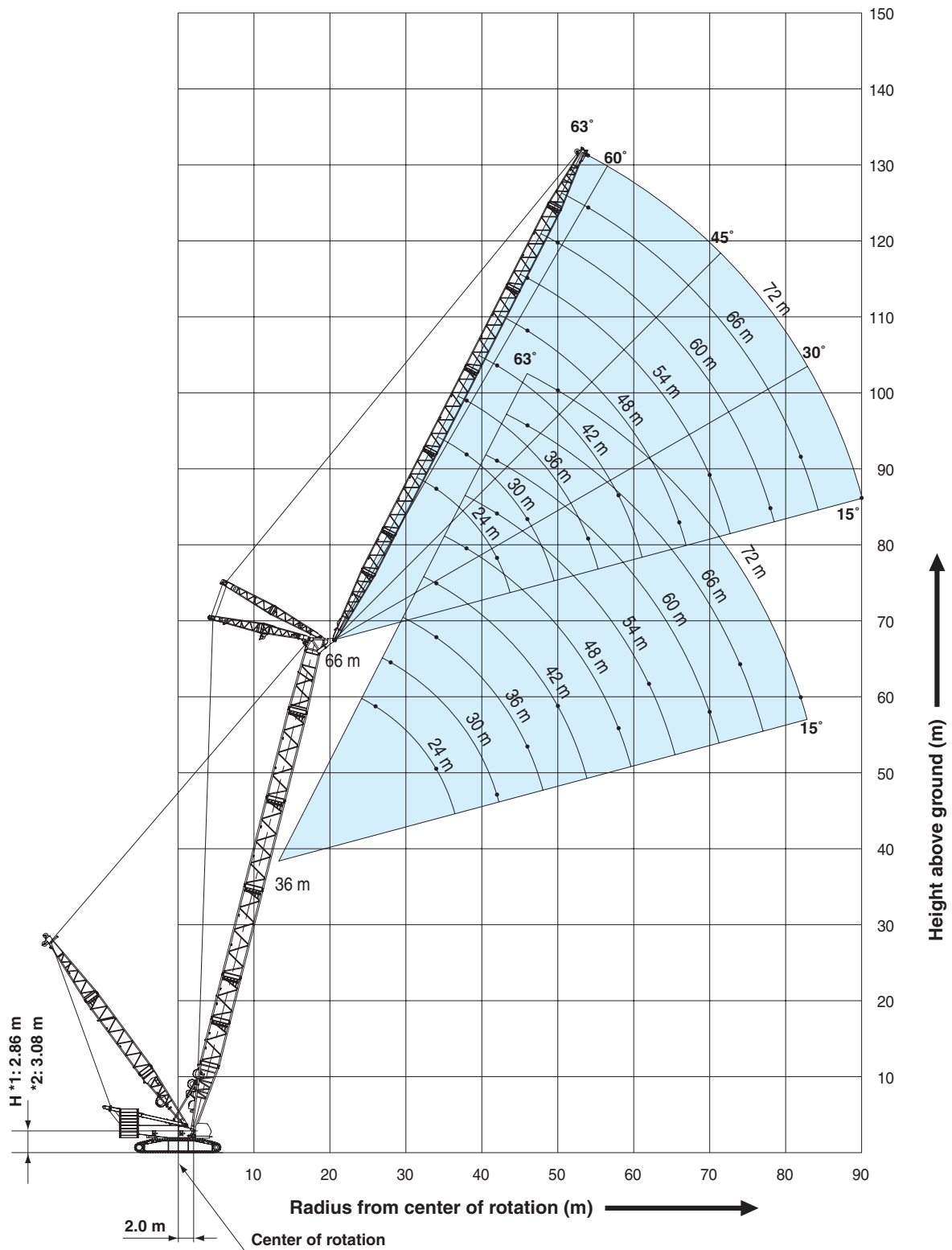

1: Without upper/lower connecting device
2: With upper/lower connecting device

Luffing Jib

Boom Angle: 66°

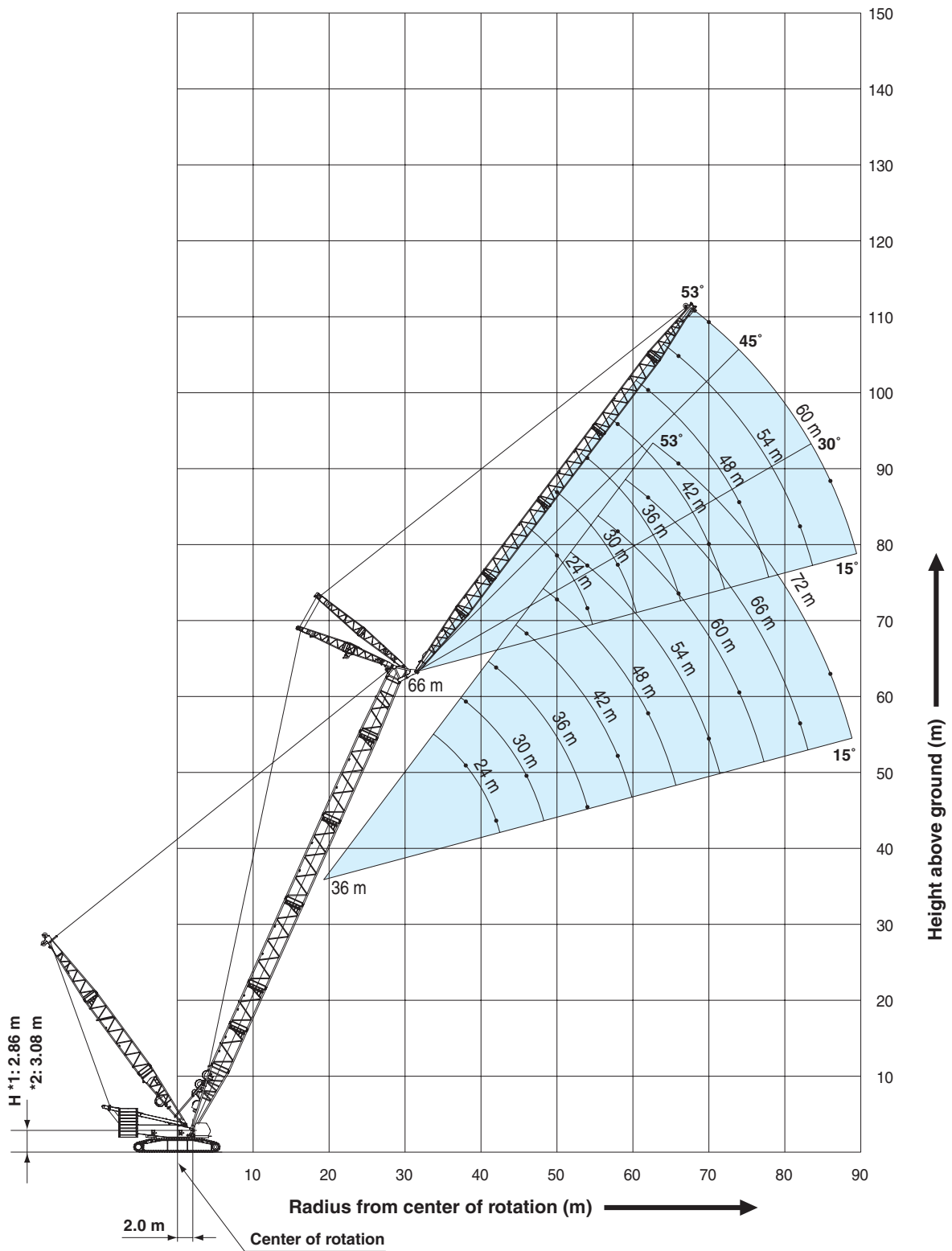

1: Without upper/lower connecting device
 2: With upper/lower connecting device

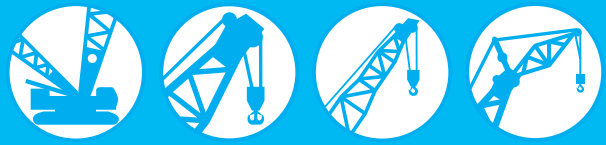

LIFTING CAPACITIES

Heavy Duty Crane Boom Lifting Capacities

Unit: ton

Counterweight: 180.0 ton, Carbody weight: 50.0 ton
HL Mast point radius: 11 m to 16 m

Working Radius (m)	36.0		42.0	
	Boom Length (m)	Working Radius (m)	Boom Length (m)	Working Radius (m)
8.0	8.3 m/367.5			8.0
9.0	330.0	9.2 m/323.3		9.0
10.0	286.4	286.9		10.0
12.0	225.4	225.9		12.0
14.0	184.9	185.2		14.0
16.0	156.0	156.1		16.0
18.0	134.4	134.3		18.0
20.0	117.7	117.4		20.0
22.0	104.1	103.9		22.0
24.0	93.2	92.8		24.0
26.0	84.0	83.6		26.0
28.0	76.2	75.9		28.0
30.0	69.5	69.1		30.0
32.0	63.5	63.3		32.0
34.0	33.8 m/58.7	58.2		34.0
36.0		53.7		36.0
38.0		49.7		38.0
40.0		39.0 m/47.8		40.0
Reeves	28	24		Reeves

Note:
Designed and rated to comply with EN13000 .
Ratings shown in [] are determined by the strength of the boom or other structural components.

Long Boom Lifting Capacities

Unit: ton

Counterweight: 180.0 ton, Carbody weight: 50.0 ton
HL Mast point radius: 11 m to 16 m

Working Radius (m)	90.0		96.0		102.0		108.0	
	Boom Length (m)	Working Radius (m)	Boom Length (m)	Working Radius (m)	Boom Length (m)	Working Radius (m)	Boom Length (m)	Working Radius (m)
14.0	15.0 m/98.0		15.8 m/98.0					14.0
16.0	98.0	98.0	16.6 m/84.0	17.5 m/84.0				16.0
18.0	98.0	98.0	84.0	84.0				18.0
20.0	98.0	97.5	84.0	84.0				20.0
22.0	89.9	87.4	84.0	81.9				22.0
24.0	81.0	78.8	75.9	73.8				24.0
26.0	73.5	71.5	68.7	66.7				26.0
28.0	66.9	65.1	62.3	60.5				28.0
30.0	61.1	59.4	56.8	55.1				30.0
32.0	56.0	54.4	51.8	50.3				32.0
34.0	51.5	49.9	47.5	46.0				34.0
36.0	47.4	45.9	43.5	42.1				36.0
38.0	43.5	42.3	40.0	38.7				38.0
40.0	39.9	39.0	36.7	35.5				40.0
44.0	33.8	33.2	31.1	30.0				44.0
48.0	28.9	28.3	26.4	25.3				48.0
52.0	24.7	24.2	22.4	21.4				52.0
56.0	21.2	20.7	18.9	18.0				56.0
60.0	18.2	17.6	15.9	15.0				60.0
64.0	15.4	14.8	13.3	12.4				64.0
68.0	13.0	12.4	10.9	10.0				68.0
72.0	10.8	10.2	8.9	8.0				72.0
76.0	8.9	8.3	7.0	6.2				76.0
80.0	80.1 m/7.2	6.7						80.0
Reeves	7	7	6	6				Reeves

Note:
Designed and rated to comply with EN13000 .
Ratings shown in [] are determined by the strength of the boom or other structural components.

Heavy Fixed Jib (Type B1) Lifting Capacities

Unit: ton

Counterweight: 200.0 ton, Carbody weight: 50.0 ton
HL Mast point radius: 11 m

Working Radius (m)	18.0		
	Boom Length (m)	Working Radius (m)	Working Radius (m)
20.0	120.0	120.0	117.0
22.0	107.9	107.2	104.8
24.0	95.5	94.6	93.7
26.0	85.1	84.2	83.2
28.0	76.3	75.4	74.4
30.0	68.8	67.8	66.8
34.0	56.6	55.6	54.4
38.0	47.1	46.0	44.9
42.0	39.5	38.4	37.2
46.0	33.3	32.2	31.0
50.0	28.2	27.0	25.8
54.0	23.8	22.6	21.4
58.0	20.1	18.9	17.6
62.0	16.9	15.7	14.4
66.0	14.1	12.9	11.5
70.0	11.6	10.4	9.1
Reeves	10	10	10

Note:
Designed and rated to comply with EN13000 .
Ratings shown in [] are determined by the strength of the boom or other structural components.
Ratings enclosed in gray-color box in the table require double-drum specifications.



Luffing Boom Lifting Capacities

Unit: ton

Counterweight: 180.0 ton, Carbody weight: 50.0 ton
HL Mast point radius: 11 m to 16 m

Boom Length (m) Working Radius (m)	36.0	42.0	48.0	54.0	60.0	66.0	72.0	78.0	84.0	Boom Length (m) Working Radius (m)
8.0	8.5 m/300.0									8.0
9.0	300.0	9.3 m/300.0								9.0
10.0	286.5	287.1	10.2 m/280.5	11.0 m/252.1	11.8 m/225.4					10.0
12.0	224.9	225.3	225.0	224.6	221.9	12.7 m/199.7	13.5 m/178.2			12.0
14.0	184.0	184.2	183.8	183.3	183.0	178.8	171.2	14.3 m/160.6	15.2 m/145.2	14.0
16.0	154.8	154.9	154.6	153.9	153.4	152.7	147.4	142.2	137.0	16.0
18.0	132.9	132.9	132.6	132.0	131.4	129.7	128.5	124.1	119.7	18.0
20.0	116.0	115.9	115.5	114.8	114.3	113.5	112.6	109.5	105.6	20.0
22.0	102.4	102.2	101.9	101.2	100.6	99.8	98.9	97.3	93.8	22.0
24.0	91.3	91.1	90.7	90.1	89.6	88.6	87.7	87.1	84.0	24.0
26.0	82.0	81.8	81.4	80.8	80.3	79.3	78.3	77.6	75.5	26.0
28.0	74.2	74.0	73.5	72.9	72.4	71.5	70.4	69.7	68.2	28.0
30.0	67.5	67.2	66.8	66.1	65.7	64.8	63.8	63.0	61.8	30.0
32.0	61.6	61.4	60.9	60.3	59.8	58.9	58.0	57.1	56.1	32.0
34.0	33.9 m/56.6	56.3	55.8	55.1	54.7	53.8	52.8	52.0	51.1	34.0
36.0		51.7	51.3	50.6	50.2	49.3	48.3	47.4	46.4	36.0
38.0		47.7	47.3	46.6	46.1	45.3	44.3	43.6	42.6	38.0
40.0		39.1 m/45.6	43.6	43.0	42.5	41.7	40.7	40.0	39.0	40.0
42.0			40.4	39.7	39.3	38.4	37.5	36.7	35.6	42.0
44.0			37.4	36.8	36.3	35.5	34.5	33.7	32.7	44.0
46.0			44.3 m/37.0	34.1	33.7	32.8	31.8	31.0	30.0	46.0
48.0				31.6	31.2	30.4	29.3	28.5	27.3	48.0
50.0				49.5 m/29.9	29.0	28.1	27.1	26.1	24.9	50.0
52.0					26.9	26.0	25.0	23.9	22.6	52.0
54.0					25.0	24.1	23.0	21.8	20.6	54.0
56.0					54.7 m/24.3	22.4	21.2	20.0	18.7	56.0
58.0						20.7	19.5	18.3	16.9	58.0
60.0						59.9 m/19.2	18.0	16.7	15.3	60.0
62.0							16.6	15.3	13.9	62.0
64.0							15.4	14.0	12.5	64.0
66.0							65.1 m/14.8	12.8	11.2	66.0
68.0								11.7	10.0	68.0
70.0								10.6	8.8	70.0
72.0								70.3 m/10.5	7.7	72.0
Reeves	24	24	24	20	20	16	16	12	12	Reeves

Note:
Designed and rated to comply with EN13000.
Ratings shown in are determined by the strength of the boom or other structural components.
Ratings enclosed in gray-color box in the table require double-drum specifications.

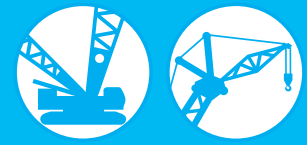

LIFTING CAPACITIES

Luffing Jib Lifting Capacity

Unit: ton

Counterweight: 180.0 ton, Carbody weight: 50.0 ton
HL Mast point radius: 16 m

36.0 m Boom Length	Boom length (m)		36.0												Boom length (m)				
	Jib length (m)		24.0			42.0			54.0			66.0			72.0			Jib length (m)	
	Boom angle		86°	76°	66°	86°	76°	66°	86°	76°	66°	86°	76°	66°	86°	76°	66°	Boom angle	
Working Radius (m)	14.0	14.4 m/200.0																14.0	
	15.0	193.2																15.0	
	16.0	181.9																16.0	
	17.0	170.3																17.0	
	18.0	159.4																18.0	
	20.0	141.1				132.7												20.0	
	22.0	126.4				120.5												22.0	
	24.0	114.4				110.2			101.5									24.0	
	26.0	103.2	96.0			101.4			96.5									26.0	
	28.0	93.9	87.3			92.1			89.3			76.0						28.0	
	30.0	85.9	79.9			84.3			83.0			74.1			64.3			30.0	
	34.0		68.2			71.7	65.9		70.9			68.8			60.0			34.0	
	38.0			54.8		62.2	57.0		61.3			60.2			54.2			38.0	
	42.0			48.2		54.7	50.1		53.8	48.1		52.7			49.3			42.0	
	46.0					48.7	44.5	40.4	47.7	43.3		46.6	40.5		45.1			46.0	
	50.0						39.9	36.2	42.7	38.7		41.6	37.4		41.1	35.0		50.0	
	54.0							32.6	38.6	34.8	30.5	37.4	33.5		36.9	33.0		54.0	
	58.0							29.7	35.1	31.6	28.3	33.8	30.2		33.4	29.7		58.0	
	62.0									28.8	25.7	30.8	27.4	22.8	30.3	26.9		62.0	
	66.0										23.5	28.2	25.0	22.0	27.7	24.5	19.4	66.0	
70.0										21.6	25.9	22.9	20.0	25.4	22.3	19.4	70.0		
74.0												21.0	18.3	23.4	20.5	17.7	74.0		
78.0													16.8		18.8	16.2	78.0		
82.0													15.5		17.4	14.9	82.0		
86.0																13.7	86.0		
Reeves			16			12			8			8			8		Reeves		

42.0 m Boom Length	Boom length (m)		42.0												Boom length (m)				
	Jib length (m)		24.0			42.0			54.0			66.0			72.0			Jib length (m)	
	Boom angle		86°	76°	66°	86°	76°	66°	86°	76°	66°	86°	76°	66°	86°	76°	66°	Boom angle	
Working Radius (m)	15.0	15.4 m/181.6																15.0	
	16.0	175.9																16.0	
	17.0	166.1																17.0	
	18.0	156.3																18.0	
	20.0	140.0																20.0	
	22.0	125.4				116.7												22.0	
	24.0	113.5				106.9			94.1									24.0	
	26.0	102.7				98.4			93.1									26.0	
	28.0	93.4	85.4			91.2			86.7			74.9						28.0	
	30.0	85.5	78.2			83.8			80.6			73.6			61.0			30.0	
	34.0		66.6			71.3			70.4			66.9			58.9			34.0	
	38.0		57.8	52.5		61.8	55.5		60.9			59.1			54.0			38.0	
	42.0			46.1		54.3	48.7		53.4	46.7		52.3			48.9			42.0	
	46.0					48.4	43.2		47.4	42.1		46.3	39.1		45.0			46.0	
	50.0						38.7	34.1	42.4	37.6		41.3	36.2		40.8	33.7		50.0	
	54.0						35.0	30.9	38.3	33.8		37.1	32.4		36.7	32.0		54.0	
	58.0							28.0	34.8	30.6	25.7	33.5	29.2		33.1	28.7		58.0	
	62.0							25.6		27.8	24.1	30.5	26.5	20.9	30.0	26.0		62.0	
	66.0									25.5	22.0	27.9	24.1	20.5	27.4	23.6	17.4	66.0	
	70.0										20.2	25.7	22.0	18.6	25.1	21.5	17.4	70.0	
74.0										18.6		20.2	17.0	23.1	19.7	16.3	74.0		
78.0												18.7	15.5		18.0	14.8	78.0		
82.0													14.3		16.6	13.5	82.0		
86.0																12.3	86.0		
90.0																	11.2	90.0	
Reeves			16			12			8			8			8		Reeves		

Note: Designed and rated to comply with EN13000.

Ratings shown in are determined by the strength of the boom or other structural components.

Ratings enclosed in gray-color box in the table require double-drum specifications.

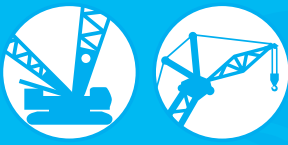

Luffing Jib Lifting Capacity

Unit: ton

Counterweight: 180.0 ton, Carbody weight: 50.0 ton
HL Mast point radius: 16 m

48.0 m Boom Length	Boom length (m)		48.0												Boom length (m)				
	Jib length (m)		24.0			42.0			54.0			66.0			72.0			Jib length (m)	
	Boom angle		86°	76°	66°	86°	76°	66°	86°	76°	66°	86°	76°	66°	86°	76°	66°	Boom angle	
Working Radius (m)	16.0	16.2 m/167.4																16.0	
	17.0	160.1																17.0	
	18.0	150.8																18.0	
	20.0	135.8																20.0	
	22.0	123.4				113.0												22.0	
	24.0	112.6				103.6			90.2									24.0	
	26.0	102.2				95.5			88.0									26.0	
	28.0	92.9	83.4			88.4			84.1			67.3						28.0	
	30.0	85.0	76.3			82.3			78.3			66.0			58.4			30.0	
	34.0		65.0			70.9			68.5			62.9			56.3			34.0	
	38.0		56.3			61.4	53.9		60.5			57.4			53.8			38.0	
	42.0			43.9		53.9	47.3		53.1	45.1		51.2			48.6			42.0	
	46.0			38.9		48.0	41.9		47.0	40.8		45.9			44.8			46.0	
	50.0						37.5	32.1	42.1	36.4		41.0	33.2		40.4	32.3		50.0	
	54.0						33.8	29.0	37.9	32.6		36.8	31.1		36.4	30.0		54.0	
	58.0							26.2	34.5	29.5	23.8	33.3	28.2		32.8	27.1		58.0	
	62.0							23.8		26.8	22.5	30.2	25.5		29.8	24.6		62.0	
	66.0									24.6	20.4	27.6	23.2	16.5	27.2	22.4		66.0	
	70.0										18.6	25.4	21.1	16.5	24.9	20.5	13.5	70.0	
	74.0											17.1		19.4	15.0	22.9	18.8	13.5	74.0
78.0													17.8	13.7		17.2	12.7	78.0	
82.0														12.5		15.8	11.5	82.0	
86.0															11.6		10.4	86.0	
90.0																	9.5	90.0	
	Reeves		16			12			8			8			8			Reeves	

54.0 m Boom Length	Boom length (m)		54.0												Boom length (m)				
	Jib length (m)		24.0			42.0			54.0			66.0			72.0			Jib length (m)	
	Boom angle		86°	76°	66°	86°	76°	66°	86°	76°	66°	86°	76°	66°	86°	76°	66°	Boom angle	
Working Radius (m)	17.0	154.3																17.0	
	18.0	145.5																18.0	
	20.0	131.2																20.0	
	22.0	119.3				109.3												22.0	
	24.0	109.4				100.2												24.0	
	26.0	101.0				92.5			80.7									26.0	
	28.0	92.4				85.7			78.2			63.1						28.0	
	30.0	84.5	74.3			79.8			75.6			61.8			55.1			30.0	
	34.0		63.2			69.9			66.5			58.7			52.9			34.0	
	38.0		54.7			60.9	51.7		58.9			55.2			50.3			38.0	
	42.0			41.4		53.5	45.8		52.6			49.6			47.5			42.0	
	46.0			36.7		47.6	40.5		46.7	38.2		44.6			43.4			46.0	
	50.0						36.2		41.7	34.8		40.3	31.8		39.2			50.0	
	54.0						32.6	26.7	37.6	31.5		36.5	28.9		35.5	27.2		54.0	
	58.0						29.6	24.3	34.2	28.4		33.0	26.1		32.4	25.1		58.0	
	62.0							22.0		25.8	19.0	30.0	23.7		29.5	22.7		62.0	
	66.0							20.1		23.5	18.2	27.4	21.6		26.9	20.6		66.0	
	70.0										16.6	25.1	19.8	12.6	24.6	18.8		70.0	
	74.0										15.2		18.2	12.6	22.6	17.1	9.8	74.0	
	78.0										14.1		16.8	11.4		15.7	9.8	78.0	
82.0													10.3		14.4	9.3	82.0		
86.0													9.3		13.4	8.3	86.0		
90.0													8.6			7.4	90.0		
94.0																6.7	94.0		
	Reeves		12			8			8			8			8			Reeves	

Note: Designed and rated to comply with EN13000.
Ratings shown in are determined by the strength of the boom or other structural components.
Ratings enclosed in gray-color box in the table require double-drum specifications.

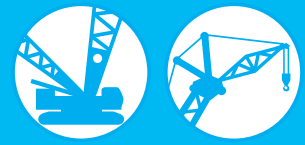

LIFTING CAPACITIES

Luffing Jib Lifting Capacity

Unit: ton

Counterweight: 180.0 ton, Carbody weight: 50.0 ton
HL Mast point radius: 16 m

60.0 m Boom Length	Boom length (m)		60.0												Boom length (m)				
	Jib length (m)		24.0			42.0			54.0			66.0			72.0			Jib length (m)	
	Boom angle		86°	76°	66°	86°	76°	66°	86°	76°	66°	86°	76°	66°	86°	76°	66°	Boom angle	
Working Radius (m)	17.0	17.8 m/141.8																17.0	
	18.0	140.3																18.0	
	20.0	126.7																20.0	
	22.0	115.4				103.2												22.0	
	24.0	105.9				97.0												24.0	
	26.0	97.8				89.5			76.5									26.0	
	28.0	90.8				83.0			74.2									28.0	
	30.0	84.0				77.3			71.7				58.2					30.0	
	34.0		61.4			67.8			64.4				55.3			49.4		34.0	
	38.0		53.1			60.2			57.1				52.1			47.0		38.0	
	42.0		46.6			53.1	43.2		51.0				48.1			44.3		42.0	
	46.0			34.5		47.1	38.7		46.0	36.1			43.2			41.6		46.0	
	50.0			30.7			34.9		41.3	32.5			39.0	29.7		37.9		50.0	
	54.0						31.3		37.2	29.3			35.4	26.7		34.4	25.7	54.0	
	58.0						28.4	21.7	33.8	26.6			32.3	24.1		31.3	23.1	58.0	
	62.0							19.7		24.3	16.8		29.6	21.8		28.6	20.8	62.0	
	66.0							18.0		22.4	15.6		27.1	19.8		26.3	18.8	66.0	
	70.0									20.6	14.1		24.8	18.0	10.5	24.2	17.0	70.0	
	74.0										12.8			16.5	10.3	22.4	15.5	74.0	
	78.0										11.7			15.1	9.1	20.6	14.1	78.0	
82.0													14.1	8.1		12.9	82.0		
86.0														7.2		11.9	86.0		
90.0														6.5			90.0		
Reeves			12			8			8				8			8		Reeves	

66.0 m Boom Length	Boom length (m)		66.0												Boom length (m)				
	Jib length (m)		24.0			42.0			54.0			66.0			72.0			Jib length (m)	
	Boom angle		86°	76°	66°	86°	76°	66°	86°	76°	66°	86°	76°	66°	86°	76°	66°	Boom angle	
Working Radius (m)	18.0	18.5 m/131.7																18.0	
	20.0	122.2																20.0	
	22.0	111.4				95.3												22.0	
	24.0	102.3				91.5												24.0	
	26.0	94.5				86.5			71.3									26.0	
	28.0	87.8				80.3			68.1									28.0	
	30.0	82.0				74.8			66.6				55.1					30.0	
	34.0		57.5			65.6			61.6				52.2			46.4		34.0	
	38.0		50.8			58.2			55.2				49.0			44.0		38.0	
	42.0		45.0			52.2	40.1		49.3				45.7			41.4		42.0	
	46.0					46.7	35.9		44.5	33.4			41.7			38.8		46.0	
	50.0						32.3		40.3	29.9			37.6			36.2		50.0	
	54.0			25.4			29.3		36.9	26.9			34.2	24.4		33.1	23.4	54.0	
	58.0						26.8	18.4	33.4	24.4			31.2	21.9		30.1	20.9	58.0	
	62.0							16.6		22.2			28.6	19.7		27.5	18.8	62.0	
	66.0							15.0		20.3	12.5		26.3	17.8		25.3	16.9	66.0	
	70.0							13.7		18.7	11.4		24.4	16.1		23.3	15.2	70.0	
	74.0									10.2				14.7		21.5	13.7	74.0	
	78.0										9.1					20.1	12.4	78.0	
	82.0										8.3						11.2	82.0	
86.0																10.2	86.0		
90.0																9.4	90.0		
Reeves			12			8			8				8			8		Reeves	

Note: Designed and rated to comply with EN13000.

Ratings shown in are determined by the strength of the boom or other structural components.

Ratings enclosed in gray-color box in the table require double-drum specifications.

SUPER HEAVY LIFT

BOOM AND JIB ARRANGEMENTS

Heavy Duty Crane Boom Arrangements

Boom length m (ft)	Boom arrangement
36 (118)	※
42 (138)	※

Symbol	Boom Length	Remarks
	9.0 m (29.5 ft)	Boom Base
	8.0 m (26.2 ft)	Tapered Boom
	6.0 m (19.7 ft)	Insert Boom
	12.0 m (39.4 ft)	Insert Boom
	1.0 m (3.3 ft)	Boom Top

※ indicates the most flexible combination of insert heavy duty booms, which can be modified to form all shorter heavy duty boom arrangements.

Luffing Boom Arrangements for Crane

Boom length m (ft)	Boom arrangement
36 (118)	※
42 (138)	※
48 (157)	※
54 (177)	※
60 (197)	※
66 (217)	※
72 (236)	※
78 (256)	※
84 (276)	※

Symbol	Boom Length	Remarks
	9.0 m (29.5 ft)	Boom Base
	8.0 m (26.2 ft)	Tapered Boom
	6.0 m (19.7 ft)	Insert Boom
	12.0 m (39.4 ft)	Insert Boom
	1.0 m (3.3 ft)	Boom Top

※ indicates the most flexible combination of insert luffing booms, which can be modified to form all shorter luffing boom arrangements.

Long Boom Arrangements

Boom length m (ft)	Boom arrangement
90 (295)	
96 (315)	※
102 (335)	※
108 (354)	※
114 (374)	※
120 (394)	※
126 (413)	※

Symbol	Boom Length	Remarks
	9.0 m (29.5 ft)	Boom Base
	8.0 m (26.2 ft)	Tapered Boom
	6.0 m (19.7 ft)	Insert Boom
	12.0 m (39.4 ft)	Insert Boom
	5.0 m (16.4 ft)	Luffing Insert Jib
	6.0 m (19.7 ft)	Luffing Insert Jib
	12.0 m (39.4 ft)	Luffing Insert Jib
	8.0 m (26.2 ft)	Luffing Top

※ indicates the most flexible combination of insert long booms, which can be modified to form all shorter long boom arrangements.

Heavy Fixed Jib Boom Arrangements (Type B2)

Boom length m (ft)	Boom arrangement
66 (217)	※
72 (236)	※
78 (256)	※

Symbol	Boom Length	Remarks
	9.0 m (29.5 ft)	Boom Base
	8.0 m (26.2 ft)	Tapered Boom
	6.0 m (19.7 ft)	Insert Boom
	12.0 m (39.4 ft)	Insert Boom
	1.0 m (3.3 ft)	Boom Top

↗ mark shows the guy line installing position when the fixed jib is used.
 ※ indicates the most flexible combination of insert luffing booms, which can be modified to form all shorter luffing boom arrangements.

Heavy Fixed Jib Arrangements (Type B2)

Jib length m (ft)	Jib arrangement
18 (59)	

Symbol	Jib Length	Remarks
	10.0 m (32.8 ft)	Jib Base
	8.0 m (26.2 ft)	Jib Top

Heavy Fixed Jib Boom Arrangements (Type C)

Boom length m (ft)	Boom arrangement
84 (276)	※
90 (296)	※
96 (316)	※
102 (336)	※

Symbol	Boom Length	Remarks
	9.0 m (29.5 ft)	Boom Base
	8.0 m (26.2 ft)	Tapered Boom
	6.0 m (19.7 ft)	Insert Boom
	12.0 m (39.4 ft)	Insert Boom
	1.0 m (3.3 ft)	Boom Top

↗ mark shows the guy line installing position when the fixed jib is used.
 ※ indicates the most flexible combination of insert heavy duty booms, which can be modified to form all shorter heavy duty boom arrangements.

Heavy Fixed Jib Arrangements (Type C)

Jib length m (ft)	Jib arrangement
18 (59)	

Symbol	Jib Length	Remarks
	10.0 m (32.8 ft)	Jib Base
	8.0 m (26.2 ft)	Jib Top

SUPER HEAVY LIFT

BOOM AND JIB ARRANGEMENTS

Luffing Boom Arrangements for Luffing

Boom length m (ft)	Boom arrangement
36 (118)	※
42 (138)	※
48 (157)	※
54 (177)	※
60 (197)	※
66 (217)	※
72 (236)	※
78 (256)	※
84 (276)	※

Symbol	Boom Length	Remarks
	9.0 m (29.5 ft)	Boom Base
	8.0 m (26.2 ft)	Tapered Boom
	6.0 m (19.7 ft)	Insert Boom
	12.0 m (39.4 ft)	Insert Boom
	1.0 m (3.3 ft)	Boom Top

※ indicates the most flexible combination of insert luffing booms, which can be modified to form all shorter luffing boom arrangements.

Luffing Jib Arrangements

Jib length m (ft)	Jib arrangement
24 (79)	
30 (98)	※
36 (118)	※
42 (138)	※
48 (157)	※
54 (177)	※
60 (197)	※
66 (217)	※
72 (236)	※
78 (256)	
84 (276)	※

Symbol	Jib Length	Remarks
	10.0 m (32.8 ft)	Jib Base
	6.0 m (19.7 ft)	Luffing Insert Jib
	12.0 m (39.4 ft)	Luffing Insert Jib
	8.0 m (26.2 ft)	Jib Top

※ indicates the most flexible combination of insert luffing jibs, which can be modified to form all shorter luffing jib arrangements.

SHL MAST

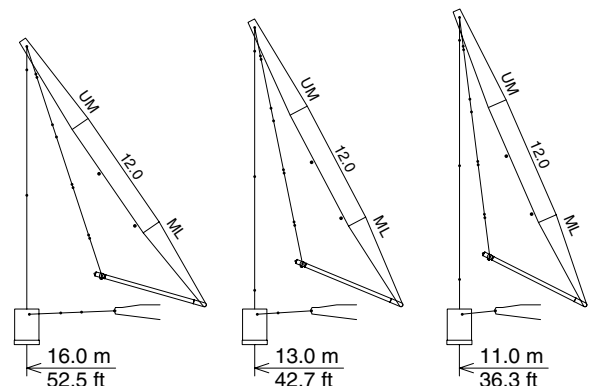

Symbol	Mast Length	Remarks
	9.0 m (29.5 ft)	Mast Base
	12.0 m (39.4 ft)	Insert Mast
	10.0 m (32.8 ft)	Mast Top

WORKING RANGES

Heavy Duty Crane Boom

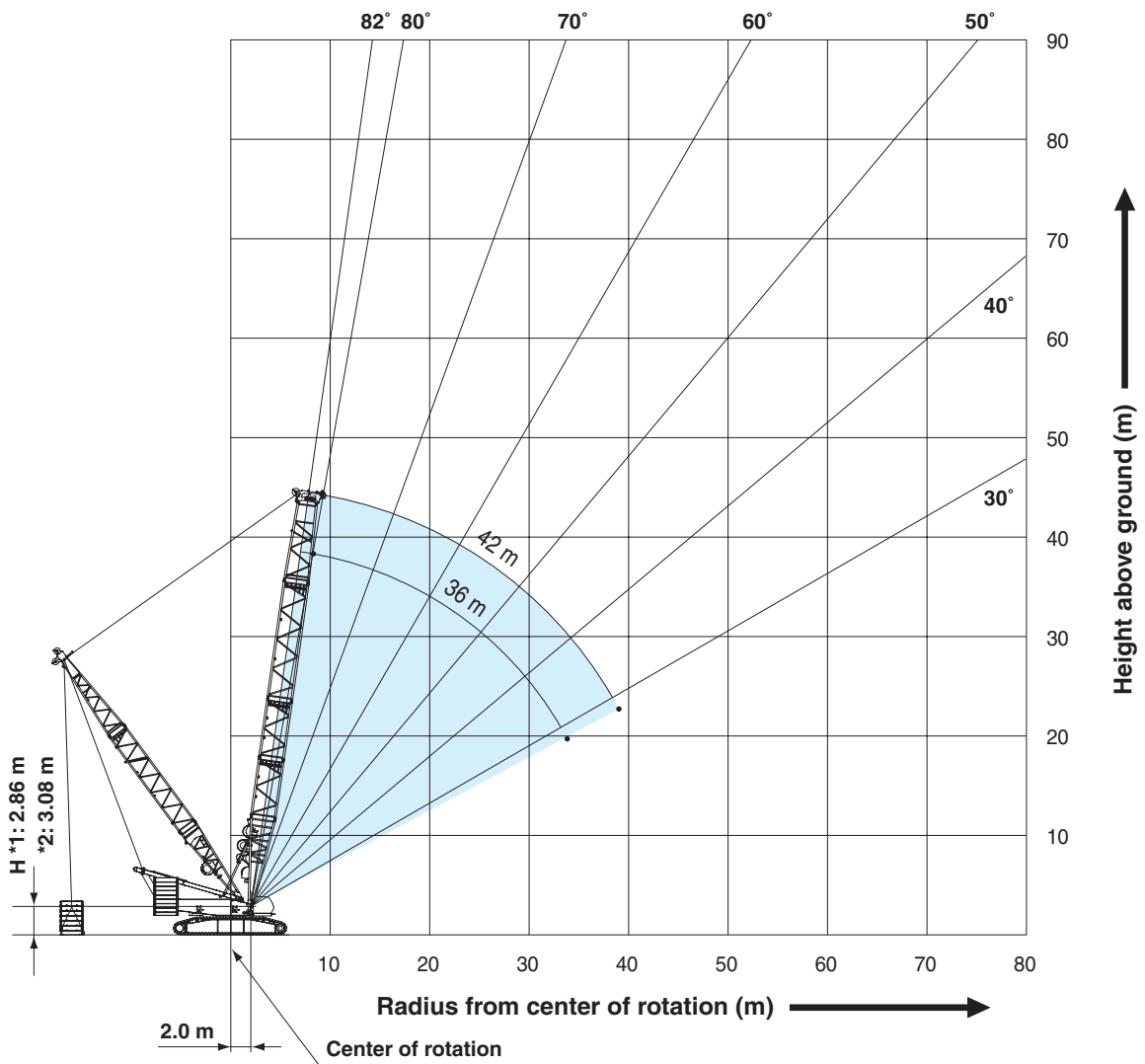

1: Without upper/lower connecting device
 2: With upper/lower connecting device

SUPER HEAVY LIFT

WORKING RANGES

Luffing Boom

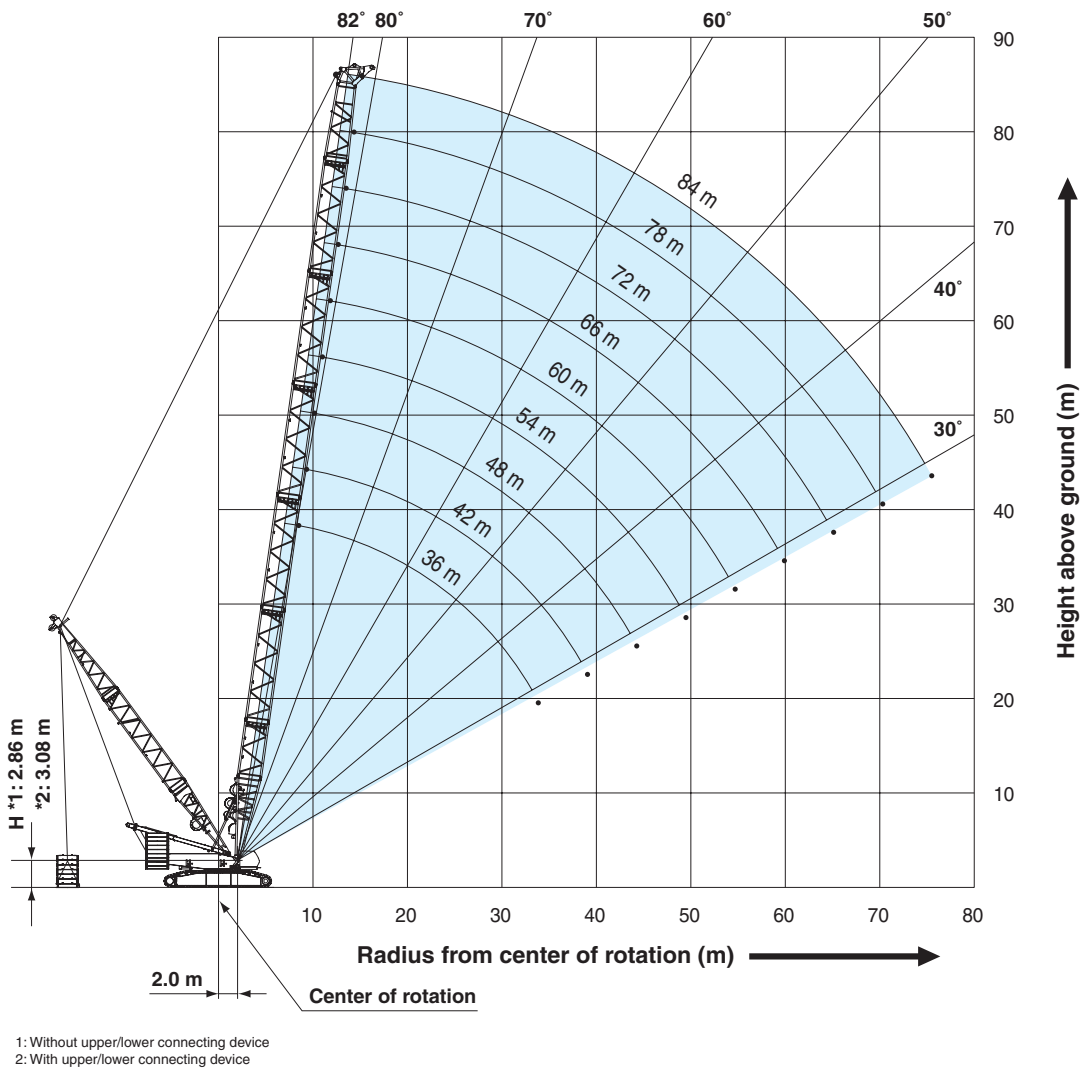

Long Boom

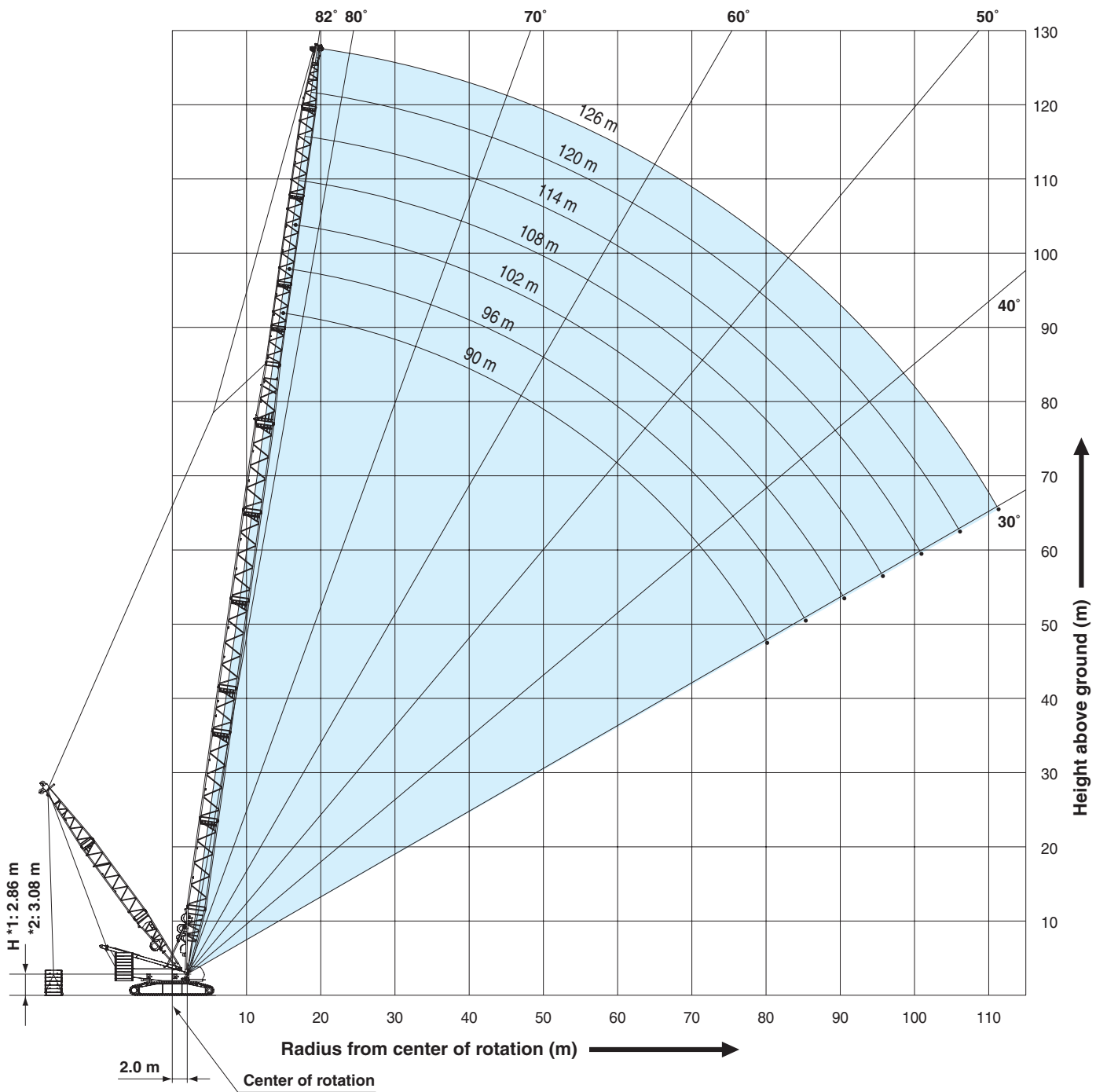

1: Without upper/lower connecting device
 2: With upper/lower connecting device

SUPER HEAVY LIFT

WORKING RANGES

Heavy Fixed Jib (Type B2)

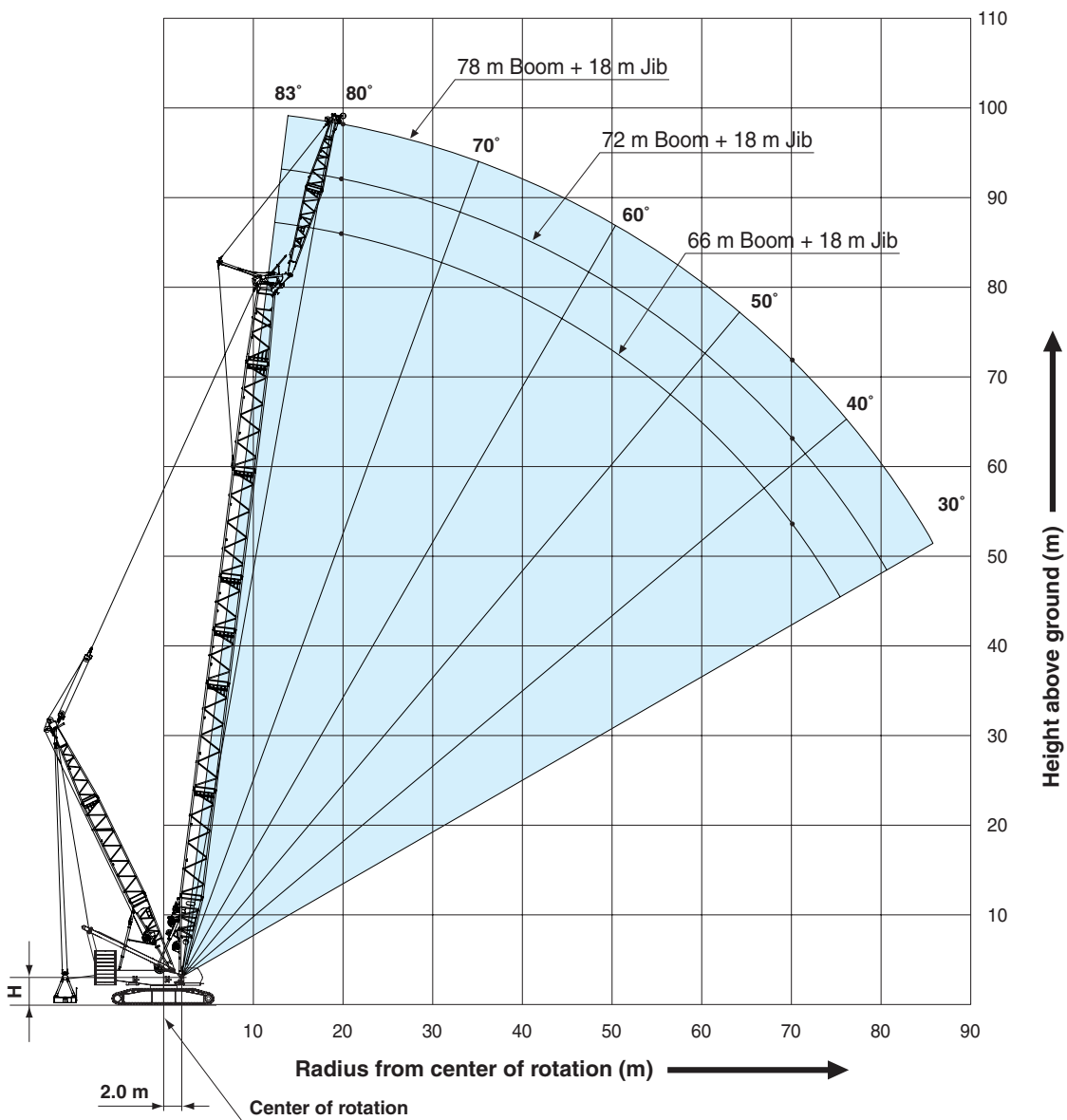

H=2.86 m Without quick connection ring
H=3.08 m With quick connection ring

Heavy Fixed Jib (Type C)

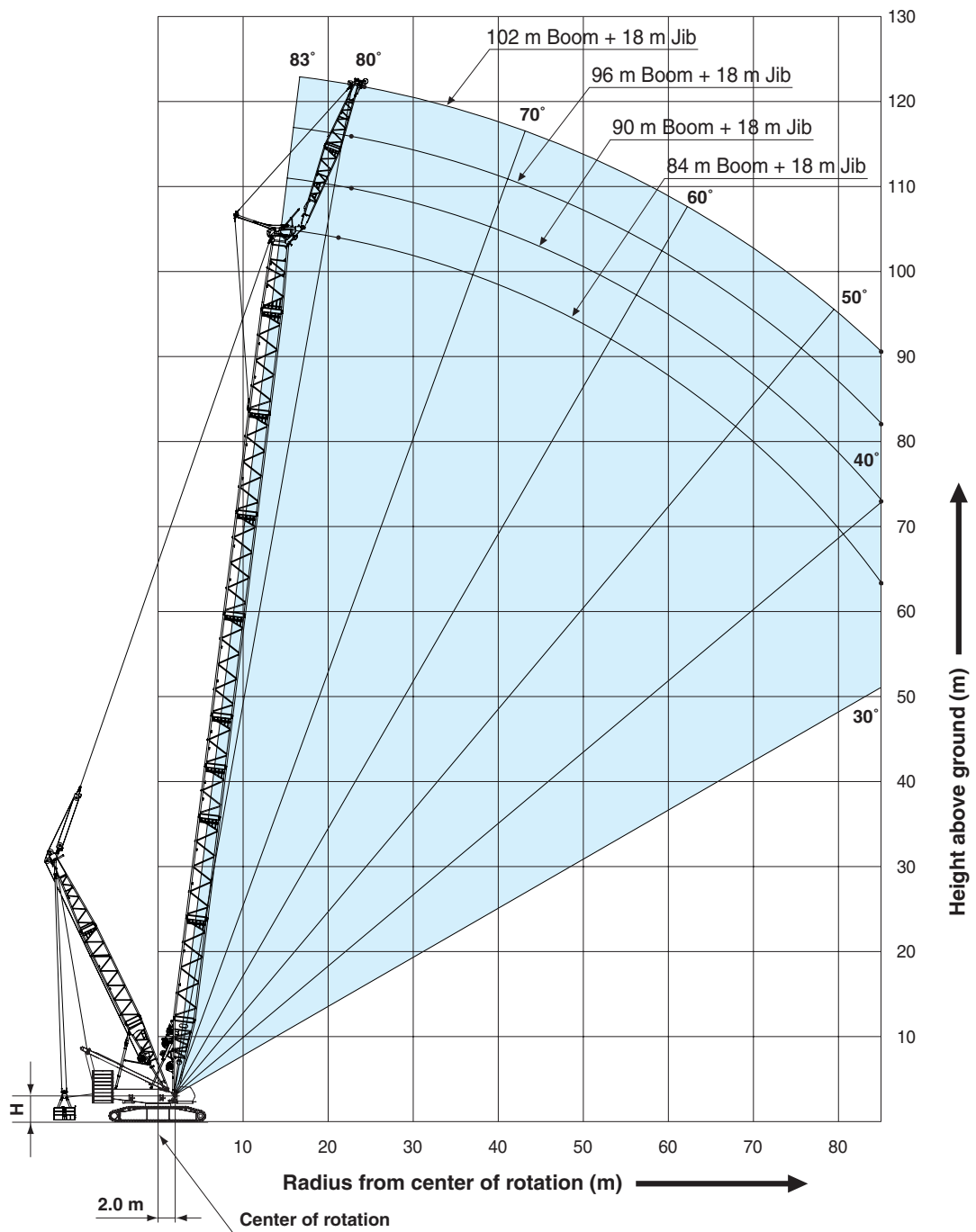

H=2.86 m Without quick connection ring
 H=3.08 m With quick connection ring

SUPER HEAVY LIFT

WORKING RANGES

Luffing Jib
Boom Angle: 86°

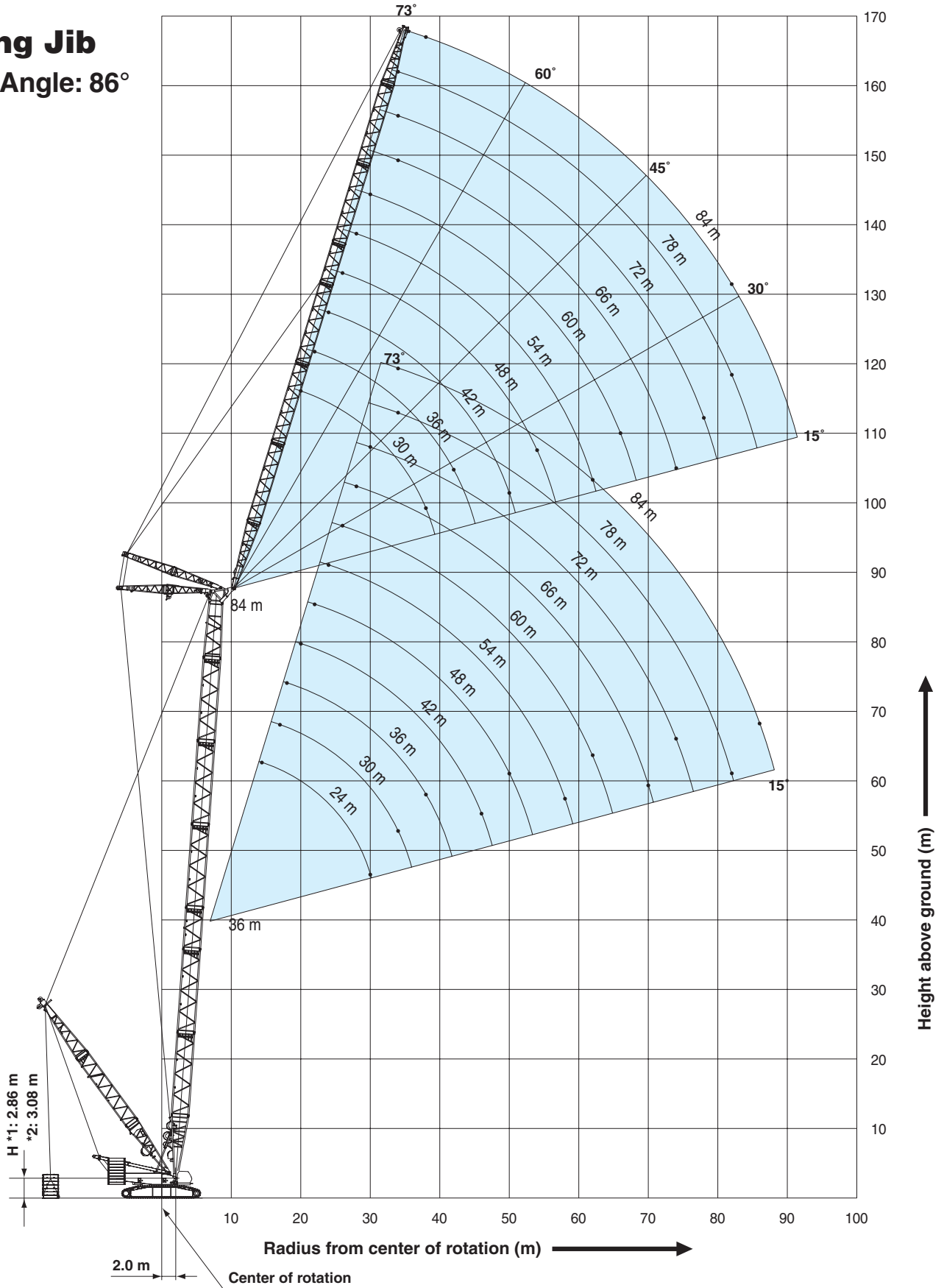

1: Without upper/lower connecting device
 2: With upper/lower connecting device

Luffing Jib

Boom Angle:
76°

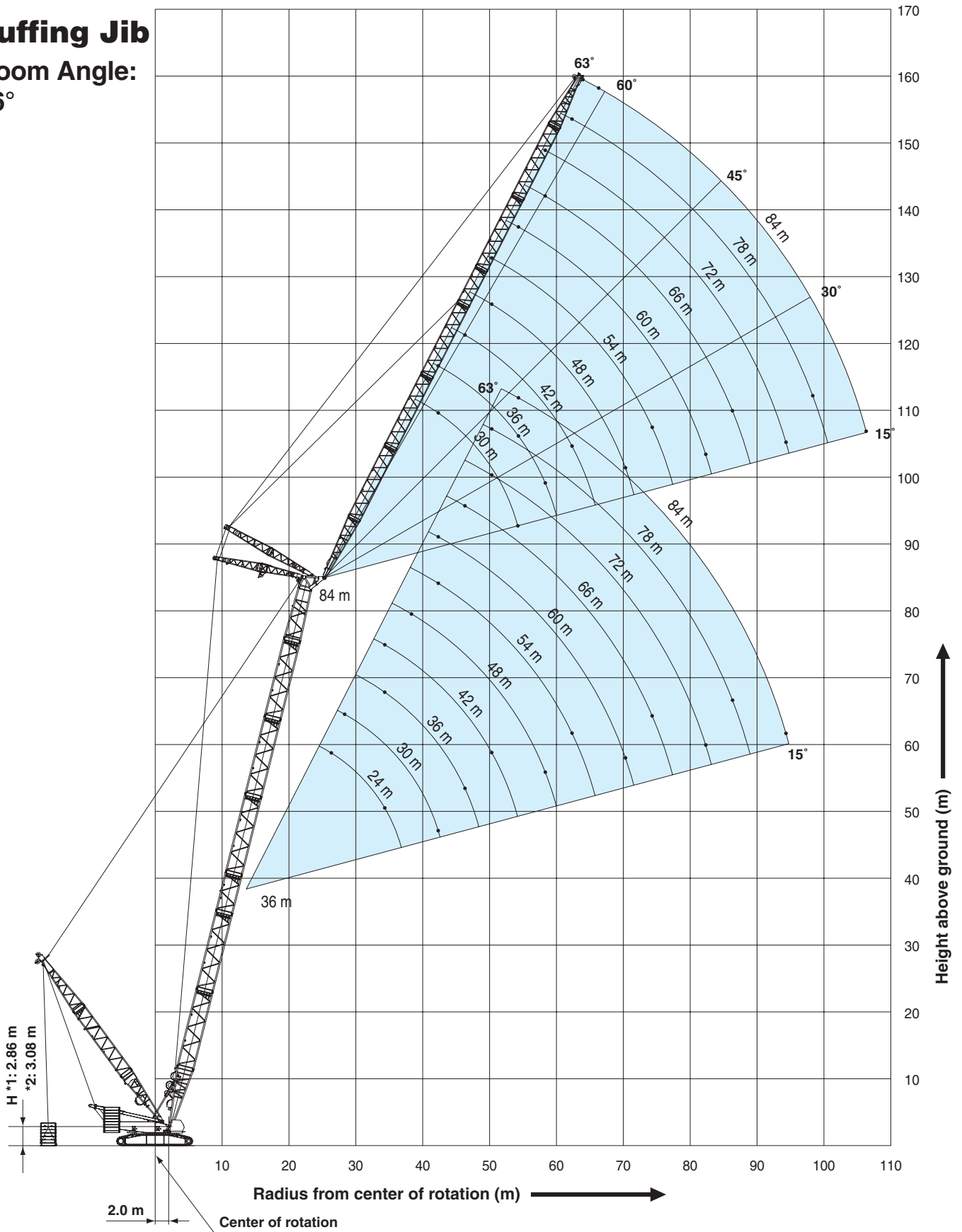

1: Without upper/lower connecting device
2: With upper/lower connecting device

SUPER HEAVY LIFT

WORKING RANGES

Luffing Jib

Boom Angle:
66°

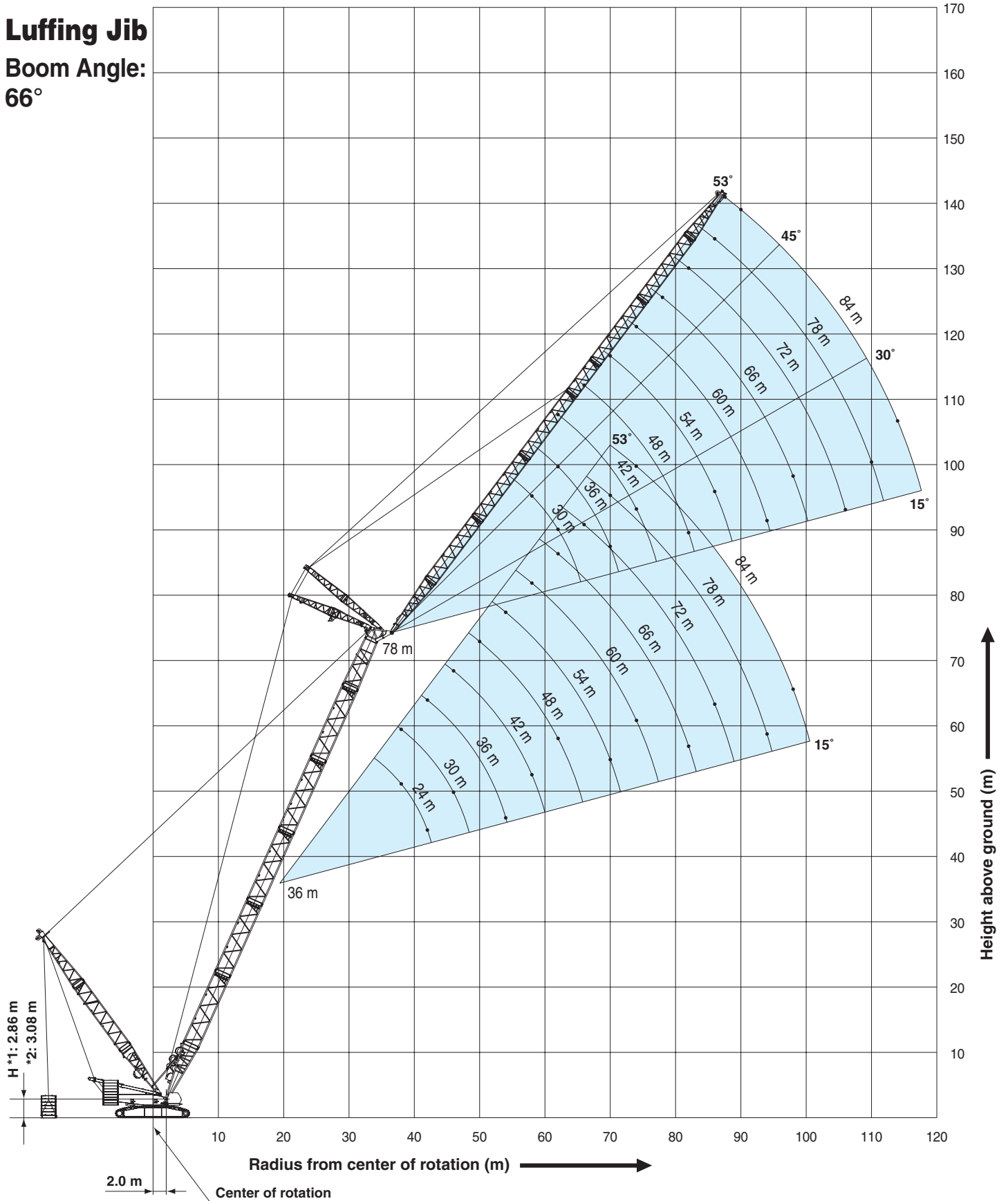

1: Without upper/lower connecting device
2: With upper/lower connecting device



Blank writing area consisting of 23 horizontal lines.



SUPER HEAVY LIFT

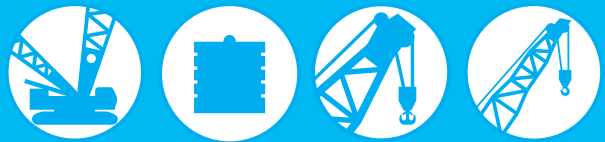

LIFTING CAPACITIES Heavy Duty Crane Boom Lifting Capacities

Unit: ton

Counterweight: 180.0 ton
Carbody weight: 50.0 ton
Pallet weight: 250.0 ton x 11 m

Working Radius (m)	Boom Length (m)		Working Radius (m)
	36.0	42.0	
8.0	8.3 m/550.0		8.0
9.0	544.9	9.2 m/523.4	9.0
10.0	511.1	510.0	10.0
12.0	428.0	427.0	12.0
14.0	367.7	366.6	14.0
16.0	321.8	320.8	16.0
18.0	285.5	284.9	18.0
20.0	255.6	255.9	20.0
22.0	228.2	228.5	22.0
24.0	205.8	206.0	24.0
26.0	187.2	187.3	26.0
28.0	170.5	171.4	28.0
30.0	154.2	157.8	30.0
32.0	139.6	146.0	32.0
34.0	33.8 m/127.4	135.7	34.0
36.0		126.3	36.0
38.0		115.7	38.0
40.0		39.0 m/110.5	40.0
Reeves	44	44	Reeves

Unit: ton

Counterweight: 180.0 ton
Carbody weight: 50.0 ton
Pallet weight: 250.0 ton x 13 m

Working Radius (m)	Boom Length (m)		Working Radius (m)
	36.0	42.0	
8.0	8.3 m/550.0		8.0
9.0	544.9	9.2 m/526.0	9.0
10.0	537.4	519.0	10.0
12.0	461.6	460.5	12.0
14.0	396.6	395.6	14.0
16.0	347.3	346.3	16.0
18.0	308.5	307.6	18.0
20.0	277.3	276.4	20.0
22.0	250.3	250.5	22.0
24.0	225.9	226.0	24.0
26.0	204.5	205.6	26.0
28.0	184.3	188.4	28.0
30.0	166.7	173.6	30.0
32.0	151.0	160.7	32.0
34.0	33.8 m/137.7	149.1	34.0
36.0		136.6	36.0
38.0		125.1	38.0
40.0		39.0 m/119.5	40.0
Reeves	44	44	Reeves

Unit: ton

Counterweight: 180.0 ton
Carbody weight: 50.0 ton
Pallet weight: 250.0 ton x 16 m

Working Radius (m)	Boom Length (m)		Working Radius (m)
	36.0	42.0	
8.0	8.3 m/550.0		8.0
9.0	544.9	9.2 m/527.3	9.0
10.0	537.4	519.9	10.0
12.0	511.5	503.7	12.0
14.0	439.6	438.8	14.0
16.0	385.3	384.2	16.0
18.0	342.4	341.4	18.0
20.0	307.9	306.9	20.0
22.0	279.5	278.5	22.0
24.0	250.7	253.5	24.0
26.0	224.9	230.9	26.0
28.0	201.5	211.7	28.0
30.0	178.8	195.2	30.0
32.0	157.9	179.2	32.0
34.0	33.8 m/139.6	164.0	34.0
36.0		148.3	36.0
38.0		132.8	38.0
40.0		39.0 m/124.8	40.0
Reeves	44	44	Reeves

Note:

Designed and rated to comply with EN13000.

Ratings shown in are determined by the strength of the boom or other structural components.

Long Boom Lifting Capacities

Unit: ton

Counterweight: 180.0 ton, Carbody weight: 50.0 ton
Pallet weight: 250.0 ton x 11 m, 13 m, 16 m

Working Radius (m)	Boom Length (m)								Working Radius (m)
	90.0	96.0	102.0	108.0	114.0	120.0	126.0		
14.0	15.0 m/98.0	15.8 m/98.0						14.0	
16.0	98.0	98.0	16.6 m/84.0	17.5 m/84.0				16.0	
18.0	98.0	98.0	84.0	84.0	18.3 m/80.0	19.2 m/70.0		18.0	
20.0	98.0	98.0	84.0	84.0	79.4	70.0	20.0 m/60.0	20.0	
22.0	98.0	98.0	84.0	84.0	78.7	70.0	59.3	22.0	
24.0	98.0	98.0	84.0	84.0	78.0	69.3	58.5	24.0	
26.0	98.0	97.7	84.0	83.9	77.3	68.7	57.8	26.0	
28.0	98.0	93.1	84.0	80.1	76.6	68.0	57.0	28.0	
30.0	98.0	89.0	84.0	76.6	75.9	67.3	53.8	30.0	
32.0	96.3	84.2	84.0	73.2	75.2	66.0	51.1	32.0	
34.0	92.7	79.8	84.0	69.9	72.2	63.0	48.4	34.0	
36.0	89.2	74.9	81.1	66.4	69.3	60.2	45.7	36.0	
38.0	86.0	69.8	77.3	62.9	66.5	57.8	43.4	38.0	
40.0	83.4	65.0	74.8	60.1	63.7	55.1	41.9	40.0	
44.0	75.9	55.7	68.2	54.8	58.8	50.3	39.4	44.0	
48.0	69.2	48.1	63.0	51.3	53.4	47.2	37.0	48.0	
52.0	64.2	43.8	58.4	47.6	50.3	44.5	34.7	52.0	
56.0	59.6	40.7	54.2	44.6	47.7	42.3	32.7	56.0	
60.0	55.4	38.1	50.1	41.8	45.1	40.2	31.0	60.0	
64.0	52.4	36.0	47.1	38.9	42.7	38.4	29.6	64.0	
68.0	50.2	34.5	45.0	36.5	40.9	36.9	28.4	68.0	
72.0	48.1	33.3	42.8	34.6	39.2	35.6	27.4	72.0	
76.0	46.3	32.2	41.0	33.0	37.6	34.3	26.5	76.0	
80.0	80.1 m/44.2	31.4	38.9	31.2	36.1	33.3	25.8	80.0	
84.0		30.8	37.9	30.3	35.1	32.4	25.1	84.0	
88.0		85.3 m/30.6	36.9	29.3	34.3	31.7	24.6	88.0	
92.0			90.5 m/36.2	28.5	33.6	31.1	23.9	92.0	
96.0				95.7 m/28.0	32.9	30.5	23.5	96.0	
100.0					30.9	30.1	22.9	100.0	
104.0					100.9 m/30.4	28.2	22.3	104.0	
108.0						106.1 m/27.2	22.0	108.0	
112.0							111.3 m/21.8	112.0	
Reeves	7	7	6	6	6	5	5	Reeves	

Note:

Designed and rated to comply with EN13000.

Ratings shown in are determined by the strength of the boom or other structural components.



Heavy Fixed Jib (Type B2) Lifting Capacities

Heavy Lift Mast Point Radius: 11 m

Unit: ton

Counterweight: 200.0 ton
Carbody weight: 50.0 ton
Pallet weight: 10.0 ton x 11 m

Jib Length (m)		18.0			Jib Length (m)	
Working Radius (m)	Boom Length (m)	66.0	72.0	78.0	Boom Length (m)	Working Radius (m)
	20.0	120.0	120.0	120.0	20.0	
22.0	116.4	114.0	108.6	22.0		
24.0	103.1	102.2	97.7	24.0		
26.0	92.0	91.1	88.3	26.0		
28.0	82.7	81.7	80.1	28.0		
30.0	74.6	73.6	72.6	30.0		
34.0	61.6	60.6	59.4	34.0		
38.0	51.5	50.4	49.2	38.0		
42.0	43.5	42.3	41.1	42.0		
46.0	36.9	35.7	34.4	46.0		
50.0	31.4	30.2	28.9	50.0		
54.0	26.8	25.6	24.2	54.0		
58.0	22.8	21.6	20.3	58.0		
62.0	19.4	18.2	16.8	62.0		
66.0	16.5	15.2	13.8	66.0		
70.0	13.9	12.6	11.2	70.0		
74.0	11.6	10.3	8.9	74.0		
Reeves	10	10	10	Reeves		

Note:

Designed and rated to comply with EN13000.

Ratings shown in are determined by the strength of the boom or other structural components.

Ratings enclosed in gray-color box in the table require double-drum specifications.

Heavy Fixed Jib (Type C) Lifting Capacities

Unit: ton

Counterweight: 200.0 ton
Carbody weight: 50.0 ton
Pallet weight: 130.0 ton x 11 m

Jib Length (m)		18.0				Jib Length (m)	
Working Radius (m)	Boom Length (m)	84.0	90.0	96.0	102.0	Boom Length (m)	Working Radius (m)
	22.0	105.0					
24.0	105.0	95.0	85.0			24.0	
26.0	105.0	95.0	85.0	80.0		26.0	
28.0	105.0	95.0	85.0	80.0		28.0	
30.0	105.0	95.0	85.0	80.0		30.0	
34.0	96.7	95.0	85.0	80.0		34.0	
38.0	82.2	81.2	80.0	78.8		38.0	
42.0	70.6	69.5	68.3	67.1		42.0	
46.0	61.2	60.0	58.8	57.6		46.0	
50.0	53.3	52.1	50.8	49.6		50.0	
54.0	46.6	45.4	44.1	42.9		54.0	
58.0	40.9	39.7	38.4	37.1		58.0	
62.0	36.0	34.8	33.4	32.1		62.0	
66.0	31.7	30.5	29.1	27.8		66.0	
70.0	27.9	26.7	25.3	24.0		70.0	
74.0	24.6	23.3	21.9	20.6		74.0	
78.0	21.6	20.3	18.9	17.6		78.0	
82.0	18.9	17.6	16.2	14.8		82.0	
86.0	84.0 m/17.7	84.0 m/16.4	84.0 m/15.0	84.0 m/13.6		86.0	
Reeves	8	8	8	8	Reeves		

Note:

Designed and rated to comply with EN13000.

Ratings shown in are determined by the strength of the boom or other structural components.

Ratings enclosed in gray-color box in the table require double-drum specifications.

SUPER HEAVY LIFT



LIFTING CAPACITIES Luffing Boom Lifting Capacities

Unit: ton

Counterweight: 180.0 ton, Carbody weight: 50.0 ton
Pallet weight: 250.0 ton x 13 m

Boom Length (m)	36.0			42.0			48.0			54.0			60.0			Boom Length (m)	Working Radius (m)
	Palette weight			Palette weight			Palette weight			Palette weight			Palette weight				
Working Radius (m)	11 m	13 m	16 m	11 m	13 m	16 m	11 m	13 m	16 m	11 m	13 m	16 m	11 m	13 m	16 m	Working Radius (m)	
8.0	8.5 m/300.0	8.5 m/300.0	8.5 m/300.0													8.0	
9.0	300.0	300.0	300.0	9.3 m/300.0	9.3 m/300.0	9.3 m/300.0										9.0	
10.0	300.0	300.0	300.0	300.0	300.0	300.0	10.2 m/300.0	10.2 m/300.0	10.2 m/300.0	11.0 m/280.0	11.0 m/280.0	11.0 m/280.0	11.8 m/280.0	11.8 m/280.0	11.8 m/280.0	10.0	
12.0	300.0	300.0	300.0	300.0	300.0	300.0	300.0	300.0	300.0	280.0	280.0	280.0	280.0	280.0	280.0	12.0	
14.0	300.0	300.0	300.0	300.0	300.0	300.0	300.0	300.0	300.0	280.0	280.0	280.0	280.0	280.0	280.0	14.0	
16.0	300.0	300.0	300.0	300.0	300.0	300.0	300.0	300.0	300.0	280.0	280.0	280.0	280.0	280.0	280.0	16.0	
18.0	283.9	300.0	300.0	282.9	300.0	300.0	281.9	300.0	300.0	280.0	280.0	280.0	279.7	280.0	280.0	18.0	
20.0	253.4	275.4	300.0	253.8	274.4	300.0	252.9	273.4	300.0	251.7	272.2	280.0	250.7	271.3	280.0	20.0	
22.0	226.0	248.1	277.5	226.3	248.3	276.6	226.3	247.7	275.6	225.8	246.5	274.4	225.6	245.6	273.5	22.0	
24.0	203.6	223.7	248.9	203.8	223.8	251.3	203.7	223.6	251.0	203.2	223.1	250.2	203.0	222.7	249.7	24.0	
26.0	185.0	202.5	223.0	185.1	203.4	228.6	184.9	203.2	228.3	184.4	202.6	227.5	184.1	202.2	227.1	26.0	
28.0	168.6	182.3	199.8	169.2	186.2	209.5	169.0	185.9	209.1	168.4	185.2	208.3	168.1	184.8	207.8	28.0	
30.0	152.2	164.7	177.0	155.6	171.4	193.0	155.4	171.1	192.6	154.8	170.4	191.9	154.4	170.0	191.3	30.0	
32.0	137.6	149.0	156.1	143.8	158.5	177.2	143.6	158.2	178.4	142.9	157.5	177.6	142.5	157.1	177.0	32.0	
34.0	33.9 m/124.8	33.9 m/135.1	33.9 m/136.8	133.5	147.1	161.9	133.2	147.0	165.9	132.6	146.3	165.1	132.1	145.8	164.5	34.0	
36.0				124.2	134.5	146.4	124.1	137.1	154.9	123.4	136.3	154.1	123.0	135.8	153.5	36.0	
38.0				113.6	123.0	130.7	116.0	128.2	145.1	115.3	127.5	144.3	114.8	127.0	143.7	38.0	
40.0				39.1 m/107.9	39.1 m/116.9	39.1 m/122.1	108.7	120.3	134.3	108.0	119.6	135.5	107.5	119.1	134.9	40.0	
42.0							102.1	112.4	123.2	101.4	112.4	127.6	101.0	112.0	127.0	42.0	
44.0							95.5	103.6	111.0	95.5	106.0	120.4	95.0	105.5	119.9	44.0	
46.0							44.3 m/94.2	44.3 m/102.2	44.3 m/109.1	90.1	100.1	113.1	89.6	99.6	113.4	46.0	
48.0										85.2	94.7	104.6	84.7	94.3	107.4	48.0	
50.0										49.5 m/81.7	49.5 m/89.7	49.5 m/97.3	80.2	89.4	102.0	50.0	
52.0													76.0	84.8	96.9	52.0	
54.0													72.1	80.6	90.0	54.0	
56.0													54.7 m/70.8	54.7 m/79.2	54.7 m/87.2	56.0	
Reeves	24	24	24	24	24	24	24	24	24	20	20	20	20	20	20	Reeves	

Boom Length (m)	66.0			72.0			78.0			84.0			Boom Length (m)	Working Radius (m)
	Palette weight			Palette weight			Palette weight			Palette weight				
Working Radius (m)	11 m	13 m	16 m	11 m	13 m	16 m	11 m	13 m	16 m	11 m	13 m	16 m	Working Radius (m)	
12.0	12.7 m/280.0	12.7 m/280.0	12.7 m/280.0	13.5 m/252.0	13.5 m/252.0	13.5 m/252.0							12.0	
14.0	280.0	280.0	280.0	252.0	252.0	252.0	14.3 m/213.5	14.3 m/213.5	14.3 m/213.5	15.2 m/182.8	15.2 m/182.8	15.2 m/182.8	14.0	
16.0	280.0	280.0	280.0	252.0	252.0	252.0	213.5	213.5	213.5	182.8	182.8	182.8	16.0	
18.0	278.4	280.0	280.0	252.0	252.0	252.0	213.5	213.5	213.5	182.8	182.8	182.8	18.0	
20.0	249.4	269.9	280.0	248.1	252.0	252.0	213.5	213.5	213.5	182.8	182.8	182.8	20.0	
22.0	224.9	244.3	272.2	224.1	243.0	252.0	213.5	213.5	213.5	182.8	182.8	182.8	22.0	
24.0	202.2	221.9	248.4	201.4	221.0	247.1	200.8	213.5	213.5	182.8	182.8	182.8	24.0	
26.0	183.3	201.3	226.1	182.4	200.4	225.1	181.7	199.7	213.5	180.8	182.8	182.8	26.0	
28.0	167.2	184.0	206.8	166.3	183.0	205.8	165.7	182.3	205.0	164.7	181.2	182.8	28.0	
30.0	153.5	169.1	190.3	152.6	168.1	189.3	151.9	167.3	188.5	150.9	166.3	182.5	30.0	
32.0	141.6	156.1	176.0	140.7	155.1	175.0	140.0	154.4	174.2	138.9	153.3	173.0	32.0	
34.0	131.2	144.9	163.5	130.2	143.8	162.5	129.5	143.1	161.6	128.5	142.0	160.5	34.0	
36.0	122.0	134.9	152.5	121.1	133.9	151.4	120.3	133.1	150.6	119.2	132.0	149.4	36.0	
38.0	113.9	126.0	142.7	112.9	125.0	141.6	112.1	124.2	140.8	111.0	123.1	139.6	38.0	
40.0	106.6	118.1	133.9	105.6	117.1	132.8	104.8	116.3	132.0	103.7	115.1	130.8	40.0	
42.0	100.0	111.0	126.0	99.0	109.9	124.9	98.2	109.1	124.0	97.1	108.0	122.9	42.0	
44.0	94.1	104.5	118.8	93.1	103.5	117.7	92.3	102.7	116.9	91.2	101.5	115.7	44.0	
46.0	88.7	98.7	112.3	87.6	97.6	111.2	86.9	96.8	110.4	85.7	95.6	109.2	46.0	
48.0	83.8	93.3	106.4	82.7	92.2	105.3	81.9	91.4	104.4	80.8	90.3	103.3	48.0	
50.0	79.2	88.4	100.9	78.2	87.3	99.8	77.4	86.5	99.0	76.3	85.3	97.8	50.0	
52.0	75.1	83.9	95.9	74.0	82.8	94.8	73.2	82.0	94.0	72.1	80.8	92.8	52.0	
54.0	71.2	79.7	91.3	70.2	78.6	90.2	69.4	77.8	89.3	68.2	76.6	88.2	54.0	
56.0	67.6	75.8	87.0	66.6	74.7	85.9	65.8	73.9	85.1	64.7	72.8	83.9	56.0	
58.0	64.3	72.2	83.0	63.3	71.1	81.9	62.5	70.3	81.1	61.4	69.2	79.9	58.0	
60.0	59.9 m/61.4	59.9 m/69.0	59.9 m/77.8	60.2	67.8	78.2	59.4	67.0	77.4	58.3	65.8	76.2	60.0	
62.0				57.3	64.7	74.7	56.5	63.9	73.9	55.4	62.7	72.7	62.0	
64.0				54.6	61.7	71.5	53.8	60.9	70.7	52.7	59.8	69.5	64.0	
66.0				65.1 m/53.2	65.1 m/60.2	65.1 m/69.4	51.3	58.2	67.6	50.2	57.0	66.4	66.0	
68.0							48.9	55.6	64.7	47.8	54.4	63.6	68.0	
70.0							46.7	53.2	62.0	45.6	52.0	60.9	70.0	
72.0							70.3 m/46.4	70.3 m/52.8	70.3 m/61.7	43.4	49.7	58.3	72.0	
74.0										41.4	47.6	55.9	74.0	
76.0										75.5 m/40.0	75.5 m/46.0	75.5 m/54.2	76.0	
Reeves	20	20	20	20	20	20	16	16	16	16	16	16	Reeves	

Note: Designed and rated to comply with EN13000.

Ratings shown in are determined by the strength of the boom or other structural components.

Ratings enclosed in gray-color box in the table require double-drum specifications.



Unit: ton

Counterweight: 180.0 ton, Carbody weight: 50.0 ton
Pallet weight: 130.0 ton x 16 m

Luffing Jib Lifting Capacity

36.0 m Boom Length		36.0																		36.0 m Boom Length	
		24.0			42.0			54.0			66.0			78.0			84.0				
		Jib length (m)			Jib length (m)			Jib length (m)			Jib length (m)			Jib length (m)			Jib length (m)				
Working Radius (m)		Reeves																		Working Radius (m)	
Working Radius (m)	Boom angle	86°	76°	66°	86°	76°	66°	86°	76°	66°	86°	76°	66°	86°	76°	66°	86°	76°	66°	Boom angle	
14.0	14.4m/200.0																			14.0	
15.0	193.2																			15.0	
16.0	181.9																			16.0	
17.0	175.5																			17.0	
18.0	169.5																			18.0	
20.0	163.4				139.6															20.0	
22.0	158.1				133.8															22.0	
24.0	155.5				126.8			101.5												24.0	
26.0	145.9	154.6			120.7			99.3												26.0	
28.0	129.4	149.5			115.5			97.1			76.0									28.0	
30.0	98.3	143.8			111.2			94.4			74.1									30.0	
34.0		125.2			104.4	105.8			88.2			72.1			54.8				48.4	34.0	
38.0			105.7	89.9	101.8			81.9			69.5			53.1					47.2	38.0	
42.0			94.6	78.0	95.6			75.6	78.9		65.6			51.2					45.8	42.0	
46.0				64.8	86.7	82.3		69.4	78.9		61.7	68.8			49.0				42.7	46.0	
50.0					78.8	74.8		63.7	76.1		58.1	68.8			46.6	52.0			39.7	50.0	
54.0						68.4	56.8	70.4	66.5	53.9	67.7			44.6	50.0		37.0	39.9		54.0	
58.0						63.0	45.3	64.7	61.1	48.0	59.8			42.2	46.8		34.5	38.3		58.0	
62.0								58.5	56.4	42.9	53.2	53.3	39.7	44.0			32.3	35.9		62.0	
66.0									52.3	38.4	47.6	50.0	37.4	41.4			30.3	33.6		66.0	
70.0									48.7	32.1	42.7	46.4	35.1	39.1	39.0		28.5	31.6		70.0	
74.0											38.3	43.2	31.6	37.0	39.0	26.8	29.7	31.9		74.0	
78.0												40.4	28.5	34.9	38.6	25.3	28.1	31.0		78.0	
82.0													37.5	23.5	31.5	36.0	22.8	26.5	29.3	82.0	
86.0															28.5	33.7	19.1	25.1	27.7	86.0	
90.0																30.8		23.8	26.3	90.0	
94.0																27.8		22.6	24.9	94.0	
98.0																		23.8		98.0	
Reeves			16			12			8			8			8			8		Reeves	

42.0 m Boom Length		42.0																		42.0 m Boom Length	
		24.0			42.0			54.0			66.0			78.0			84.0				
		Jib length (m)			Jib length (m)			Jib length (m)			Jib length (m)			Jib length (m)			Jib length (m)				
Working Radius (m)		Reeves																		Working Radius (m)	
Working Radius (m)	Boom angle	86°	76°	66°	86°	76°	66°	86°	76°	66°	86°	76°	66°	86°	76°	66°	86°	76°	66°	Boom angle	
15.0	15.4m/190.6																			15.0	
16.0	187.1																			16.0	
17.0	181.8																			17.0	
18.0	177.2																			18.0	
20.0	169.7																			20.0	
22.0	164.4				127.7															22.0	
24.0	158.2				122.6			94.1												24.0	
26.0	146.3				117.2			93.1												26.0	
28.0	132.6	153.0			111.8			90.6			74.9									28.0	
30.0	108.4	141.7			106.2			87.7			73.6									30.0	
34.0		123.3			95.3			81.5			70.4			52.0				46.2		34.0	
38.0		109.0	102.9		85.2	102.4		75.1			66.7			50.2				44.9		38.0	
42.0			92.1	76.4	94.5			68.8	84.5		62.8			48.1				43.3		42.0	
46.0				67.6	85.3			62.9	83.4		58.9	72.9		45.8				41.6		46.0	
50.0					77.5	72.6		57.5	75.7		54.9	72.9		43.1				39.7		50.0	
54.0					70.9	66.4	52.6	69.1			51.1	66.9		41.1	49.7			37.2	41.6	54.0	
58.0						61.1	47.2	63.5	59.2		47.5	61.3		38.8	47.9			34.7	39.8	58.0	
62.0						56.5		58.7	54.6	43.2	54.9	52.2	36.5	44.9				32.5	37.1	62.0	
66.0								51.6	50.6	38.7	49.0	48.2	34.3	42.3				30.4	34.7	66.0	
70.0									47.1	33.5	43.9	44.7	32.2	39.9	42.8			28.6	32.6	70.0	
74.0									44.0		39.4	41.6	30.3	37.7	39.8	26.9	30.6	33.1		74.0	
78.0											35.3	38.9	28.5	35.7	37.0	25.3	28.8	32.1		78.0	
82.0												36.4	24.7	32.6	34.6	21.5	27.2	30.3		82.0	
86.0														29.5	32.3	17.6	25.7	28.6		86.0	
90.0															26.5	30.3		24.3	27.1	90.0	
94.0																28.4		23.1	25.7	94.0	
98.0																		24.4		98.0	
102.0																			23.3		102.0
Reeves			16			12			8			8			8			8		Reeves	

Note: Designed and rated to comply with EN13000.

Ratings shown in are determined by the strength of the boom or other structural components.
Ratings enclosed in gray-color box in the table require double-drum specifications.

SUPER HEAVY LIFT



LIFTING CAPACITIES

Luffing Jib Lifting Capacity

Unit: ton

Counterweight: 180.0 ton, Carbody weight: 50.0 ton
Pallet weight: 130.0 ton x 16 m

48.0 m Boom Length	48.0																Boom length (m)									
	24.0				42.0				54.0				66.0				78.0				84.0				Jib length (m)	
	86°	76°	66°	86°	76°	66°	86°	76°	66°	86°	76°	66°	86°	76°	66°	86°	76°	66°	86°	76°	66°	86°	76°	66°	Boom angle	
Working Radius (m)	16.0	16.2m/190.8																								16.0
	17.0	186.6																								17.0
	18.0	181.8																								18.0
	20.0	174.2																								20.0
	22.0	165.1				119.4																				22.0
	24.0	152.8				114.7			90.2																	24.0
	26.0	141.6				109.7			88.0																	26.0
	28.0	131.6	150.5			104.5			85.4			67.3														28.0
	30.0	117.7	139.4			99.4			82.7			66.0														30.0
	34.0		121.3			89.4			76.9			62.9			49.7							44.1				34.0
	38.0		107.2			80.1	104.0		70.8			59.5			47.9							42.8				38.0
	42.0			89.4	71.9	92.8			64.9	88.9		55.8			45.8							41.3				42.0
	46.0			80.8	64.9	83.7			59.3	81.8		52.0			43.6							39.6				46.0
	50.0					76.1	70.2	54.3	74.2		48.4	70.5			41.3							37.6				50.0
	54.0					69.6	64.2	49.7	67.8		44.6	65.5			39.0	50.9						36.0				54.0
	58.0						59.1	45.8	62.3	57.1	41.7	60.0			36.7	49.0						34.1	39.0			58.0
	62.0						54.7		57.5	52.7	38.8	55.3			34.5	45.9						32.3	37.5			62.0
	66.0								53.4	48.8	36.1	51.1	46.3	32.4	43.1							30.5	35.1			66.0
	70.0									45.4	33.8	45.9	43.0	30.4	40.6							28.7	32.9			70.0
	74.0										42.4		41.2	40.0	28.6	38.4	38.1					27.0	31.0			74.0
	78.0											36.9	37.3	26.9	36.3	35.4	24.7	29.1	32.2							78.0
	82.0												34.9	24.6	33.7	33.0	20.1	27.5	31.3							82.0
	86.0												32.7		30.5	30.8	16.1	26.0	29.5							86.0
	90.0														27.5	28.9		24.6	27.9							90.0
	94.0															27.1		23.3	26.2							94.0
	98.0															25.4			24.6							98.0
	102.0																		23.1							102.0
Reeves			16			12			8			8			8			8			8				Reeves	

54.0 m Boom Length	54.0																Boom length (m)										
	24.0				42.0				54.0				66.0				78.0				84.0				Jib length (m)		
	86°	76°	66°	86°	76°	66°	86°	76°	66°	86°	76°	66°	86°	76°	66°	86°	76°	66°	86°	76°	66°	86°	76°	66°	86°	76°	66°
Working Radius (m)	17.0	191.0																									17.0
	18.0	179.8																									18.0
	20.0	167.2																									20.0
	22.0	155.0				110.4																					22.0
	24.0	143.6				105.9																					24.0
	26.0	133.0				101.2			80.7																		26.0
	28.0	123.6				96.3			78.2			63.1															28.0
	30.0	115.5	136.7			91.5			75.6			61.8															30.0
	34.0		118.9			82.1			69.9			58.7			46.9			42.0									34.0
	38.0		105.1			73.5	101.8		64.2			55.2			45.1			40.6									38.0
	42.0			86.4	65.9	90.9			58.7			51.6			42.9			39.0									42.0
	46.0			78.0	59.4	81.9			53.6	79.9		48.0			40.7			37.3									46.0
	50.0					74.4			48.9	72.5		44.5	67.1		38.4			35.4									50.0
	54.0					68.1	61.8	44.8	66.2		41.2	63.9		36.1	50.6			33.6									54.0
	58.0					62.7	56.8	41.2	60.9		38.2	58.5		33.9	49.9			31.7	40.0								58.0
	62.0						52.5		56.2	50.5	35.4	53.9		31.7	46.9			29.9	38.4								62.0
	66.0						48.7		52.1	46.7	32.9	49.8		29.7	44.0			28.1	35.9								66.0
	70.0									43.4	30.7	46.3	40.9	27.8	41.4			26.5	33.6								70.0
	74.0									40.5		42.3	38.1	26.1	39.1	36.1	24.9	31.6									74.0
	78.0									37.9		37.9	35.5	24.5	37.0	33.5	23.3	29.7	32.6								78.0
	82.0												33.2	23.0	34.9	31.2	18.6	28.0	30.3								82.0
	86.0													31.1		31.5	29.2	14.6	26.5	28.3							86.0
	90.0													29.1		28.5	27.3		25.0	26.4							90.0
	94.0																	25.5	23.7	24.7							94.0
	98.0																	24.0		19.2	23.1						98.0
	102.0																	22.5			21.7						102.0
	106.0																				20.3						106.0
Reeves			16			8			8			8			8			8			8				Reeves		

Note: Designed and rated to comply with EN13000.

Ratings shown in are determined by the strength of the boom or other structural components.
Ratings enclosed in gray-color box in the table require double-drum specifications.



Unit: ton

Counterweight: 180.0 ton, Carbody weight: 50.0 ton
Pallet weight: 130.0 ton x 16 m

Luffing Jib Lifting Capacity

60.0 m Boom Length		60.0															60.0 m Boom Length			
Working Radius (m)	Boom length (m)	24.0			42.0			54.0			66.0			78.0			84.0			Boom length (m)
	Jib length (m)																			Jib length (m)
	Boom angle	86°	76°	66°	86°	76°	66°	86°	76°	66°	86°	76°	66°	86°	76°	66°	86°	76°	66°	Boom angle
17.0	17.8m/162.3																			17.0
18.0	161.4																			18.0
20.0	150.8																			20.0
22.0	140.5				103.2															22.0
24.0	130.7				99.1															24.0
26.0	121.7				94.8			76.5												26.0
28.0	113.5				90.4			74.2												28.0
30.0	106.4				86.0			71.7			58.2									30.0
34.0		116.7			77.4			66.4			55.3			44.5			40.0			34.0
38.0		103.1			69.5			61.0			52.1			42.7			38.6			38.0
42.0		92.3			62.5	89.0		55.9			48.7			40.7			37.1			42.0
46.0			75.3	56.6	80.2			51.1	78.2		45.3			38.5			35.4			46.0
50.0			68.6		72.9			46.7	70.9		42.0	63.5		36.3			33.6			50.0
54.0					66.7			42.8	64.7		38.9	61.9		34.0			31.9			54.0
58.0					61.4	54.6		39.5	59.5		36.1	57.1		32.0	47.6		30.1	41.6		58.0
62.0						50.4		54.9	48.3	33.5	52.5		30.0	46.3			28.3	39.8		62.0
66.0						46.8		50.9	44.7	31.1	48.6		28.1	44.9			26.6	37.1		66.0
70.0								47.4	41.6	29.1	45.1	39.0	26.3	42.2			25.1	34.7		70.0
74.0									38.7		42.0	36.2	24.7	39.8			23.6	32.5		74.0
78.0									36.2		39.2	33.7	23.2	37.4	31.7		21.8	30.5		78.0
82.0											35.2	31.5	21.4	34.9	29.5	17.1	28.7	28.6		82.0
86.0												29.5		32.6	27.5	13.1	27.1	26.5		86.0
90.0												27.6		29.5	25.7		25.6	24.8		90.0
94.0														26.3	24.1		24.2	23.2		94.0
98.0															22.5		19.3	21.7		98.0
102.0															21.1			20.3		102.0
106.0																		19.0		106.0
110.0																		17.8		110.0
Reeves		12			8			8			8			8			8			Reeves

66.0 m Boom Length		66.0															66.0 m Boom Length				
Working Radius (m)	Boom length (m)	24.0			42.0			54.0			66.0			78.0			84.0			Boom length (m)	
	Jib length (m)																			Jib length (m)	
	Boom angle	86°	76°	66°	86°	76°	66°	86°	76°	66°	86°	76°	66°	86°	76°	66°	86°	76°	66°	Boom angle	
18.0	18.5m/144.7																			18.0	
20.0	137.9																			20.0	
22.0	128.7				95.3															22.0	
24.0	120.0				91.5															24.0	
26.0	111.9				87.5			71.3												26.0	
28.0	104.5				83.3			68.1												28.0	
30.0	98.0				79.2			66.6			55.1									30.0	
34.0		114.0			71.4			61.6			52.2			41.9						34.0	
38.0		100.7			64.1			56.6			49.0			40.1			35.9			38.0	
42.0		90.1			57.7	86.8		51.7			45.7			38.1			34.4			42.0	
46.0					52.3	78.2		47.3	76.1		42.4			36.0			32.7			46.0	
50.0					65.6			71.0			39.3			33.8			31.0			50.0	
54.0					60.2			64.9			36.4	59.1		31.7			29.3			54.0	
58.0						59.8	52.0	36.5	57.8		33.7	55.4		29.7	45.1		27.5			58.0	
62.0							48.0		53.4		31.2	51.0		27.7	44.0		25.9	39.1		62.0	
66.0							44.5		49.5	42.4	29.1	47.1		25.9	42.5		24.3	37.6		66.0	
70.0							41.4		46.0	39.3	27.1	43.7		24.2	41.7		22.8	35.1		70.0	
74.0										36.6		40.6	34.1	22.7	38.8		21.4	32.9		74.0	
78.0										34.2		37.9	31.7	21.4	36.1		20.1	30.9		78.0	
82.0										32.1		35.5	29.6	19.6	33.7	27.5	15.6	29.1		82.0	
86.0													27.6		31.5	25.6	11.6	27.5	24.7	86.0	
90.0														25.9	29.5	23.9	8.3	25.9	23.0	90.0	
94.0															24.3	26.2	22.3		24.5	21.4	94.0
98.0																	20.9		19.1	20.0	98.0
102.0																	19.5			18.7	102.0
106.0																	18.3			17.4	106.0
110.0																				16.3	110.0
Reeves		12			8			8			8			8			8			Reeves	

Note: Designed and rated to comply with EN13000.
Ratings shown in are determined by the strength of the boom or other structural components.
Ratings enclosed in gray-color box in the table require double-drum specifications.

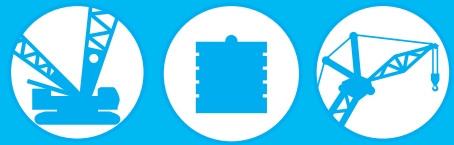

LIFTING CAPACITIES

Luffing Jib Lifting Capacity

Unit: ton

Counterweight: 180.0 ton, Carbody weight: 50.0 ton
Pallet weight: 130.0 ton x 16 m

72.0 m Boom Length	72.0																	Boom length (m)	
	24.0			42.0			54.0			66.0			78.0			84.0			Jib length (m)
	86°	76°	66°	86°	76°	66°	86°	76°	66°	86°	76°	66°	86°	76°	66°	86°	76°	66°	Boom angle
18.0	19.2m/130.3																		18.0
20.0	127.2																		20.0
22.0	119.3																		22.0
24.0	111.7			84.5															24.0
26.0	104.5			80.9			66.6												26.0
28.0	98.0			77.3			64.6												28.0
30.0	92.2			73.6			62.4			51.2									30.0
34.0		111.2		66.6			57.8			48.5			39.5						34.0
38.0		98.2		60.1			53.2			45.6			37.8			33.8			38.0
42.0		87.9		54.3	84.4		48.8			42.5			35.9			32.4			42.0
46.0				49.3	76.0		44.7			39.5			33.9			30.8			46.0
50.0				62.5	45.4	69.0	40.9	67.0		36.7			31.9			29.2			50.0
54.0				57.3		63.1	37.6	61.1	34.0	54.9			29.9			27.4			54.0
58.0					58.1		34.7	56.1	31.6	51.3			28.0	42.7		25.9			58.0
62.0					53.7	45.4		51.8	29.2	49.3			26.2	41.8		24.3	37.0		62.0
66.0						42.1		47.9		27.2	45.5			24.5	40.4		22.9	36.2	66.0
70.0						39.1		44.6	37.0	25.5	42.2			22.9	39.7		21.5	35.8	70.0
74.0						36.5		41.6	34.4		39.3			21.5	37.4		19.9	33.7	74.0
78.0									32.1		36.6	29.5	20.2	34.8		18.3	31.6		78.0
82.0									30.1		34.2	27.5	17.6	32.4	25.5	13.9	29.7		82.0
86.0									28.2			25.7		30.3	23.6	10.0	28.0	22.7	86.0
90.0												24.0		28.3	22.0		26.4	21.1	90.0
94.0												22.5		25.6	20.5		24.8	19.6	94.0
98.0																19.1	18.7	18.2	98.0
102.0																17.9	13.1	17.0	102.0
106.0																16.7		15.8	106.0
110.0																		14.7	110.0
114.0																		13.7	114.0
Reeves		12			8			8		8			8			8			Reeves

78.0 m Boom Length	78.0																	Boom length (m)	
	30.0			42.0			54.0			66.0			78.0			84.0			Jib length (m)
	86°	76°	66°	86°	76°	66°	86°	76°	66°	86°	76°	66°	86°	76°	66°	86°	76°	66°	Boom angle
20.0	20.6m/102.8																		20.0
22.0	99.2																		22.0
24.0	93.8			77.9															24.0
26.0	88.5			74.7															26.0
28.0	83.4			71.3			59.4												28.0
30.0	78.6			68.0			57.4			47.7									30.0
34.0	69.5			61.6			53.1			45.1			37.0						34.0
38.0	59.8	94.5		55.6			48.9			42.4			35.3			31.6			38.0
42.0		84.4		50.4			44.8			39.5			33.5			30.2			42.0
46.0		74.2		45.8	73.9		41.1			36.7			31.6			28.6			46.0
50.0		64.2		42.2	66.6		37.7	64.9		34.0			29.7			27.1			50.0
54.0					59.1		34.6	59.2		31.5	51.3		27.8			25.5			54.0
58.0			48.9		52.6		32.0	53.2		29.0	49.7		26.0			24.0			58.0
62.0			45.2		46.6	42.8	29.9	47.9		27.1	47.4		24.3	39.5		22.5	34.9		62.0
66.0						39.7		43.2		25.2	44.0		22.7	38.2		21.1	34.2		66.0
70.0						36.9		39.0	34.7	23.6	40.8		21.2	36.7		19.8	33.7		70.0
74.0						34.4		35.0	32.3		37.9		19.9	35.9		18.6	32.6		74.0
78.0									30.1		35.3	27.4	18.7	33.5		16.3	31.3		78.0
82.0									28.1		33.0	25.5	15.6	31.2		12.1	29.9		82.0
86.0									26.4		30.9	23.8		29.1	21.7	8.4	28.4		86.0
90.0												22.2		27.2	20.1		27.0	19.3	90.0
94.0												20.7		24.5	18.7		23.6	19.2	94.0
98.0												19.4		18.7	17.4		17.9	17.8	98.0
102.0															16.2		12.6	16.5	102.0
106.0															15.1			15.3	106.0
110.0															14.1			14.2	110.0
114.0																		13.2	114.0
Reeves		8			8			8		8			8			8			Reeves

Note: Designed and rated to comply with EN13000.
Ratings shown in are determined by the strength of the boom or other structural components.
Ratings enclosed in gray-color box in the table require double-drum specifications.



Unit: ton

Counterweight: 180.0 ton, Carbody weight: 50.0 ton
Pallet weight: 130.0 ton x 16 m

Luffing Jib Lifting Capacity

84.0 m Boom Length	84.0																	Boom length (m)																				
	Boom length (m)	30.0						42.0						54.0						66.0						72.0						78.0						Boom length (m)
	Jib length (m)	86°		76°		66°		86°		76°		66°		86°		76°		66°		86°		76°		66°		86°		76°		66°		Jib length (m)						
Working Radius (m)	Boom angle	86°	76°	66°	86°	76°	66°	86°	76°	66°	86°	76°	66°	86°	76°	66°	86°	76°	66°	86°	76°	66°	86°	76°	66°	86°	76°	66°	86°	76°	66°	Boom angle						
	20.0	21.4m/92.8																														20.0						
	22.0	90.8																														22.0						
	24.0	83.7																														24.0						
	26.0	77.4																														26.0						
	28.0	71.7																														28.0						
	30.0	66.6																														30.0						
	34.0	57.6																														34.0						
	38.0	49.6																														38.0						
	42.0		73.6																													42.0						
	46.0		63.6																													46.0						
	50.0		55.1																													50.0						
	54.0		47.2																													54.0						
	58.0																															58.0						
	62.0																															62.0						
	66.0																															66.0						
	70.0																															70.0						
	74.0																															74.0						
	78.0																															78.0						
	82.0																															82.0						
	86.0																															86.0						
	90.0																															90.0						
	94.0																															94.0						
	98.0																															98.0						
	Reeves		8				8							8																		Reeves						

Note: Designed and rated to comply with EN13000.
Ratings shown in are determined by the strength of the boom or other structural components.
Ratings enclosed in gray-color box in the table require double-drum specifications.

TRANSPORTATION PLAN

Base Machine

Base machine (1)

Base machine with mast and lower translifter without upper/lower connecting devices.

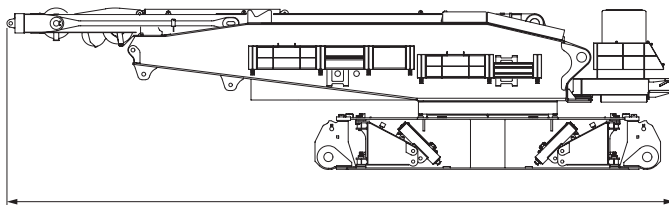

Weight	64,000 kg
Width	3.0 m
Height	3.4 m
(Machine)	
Length	14.25 m

Base machine (2)

Base machine with lower translifter without upper/lower connecting devices and mast.

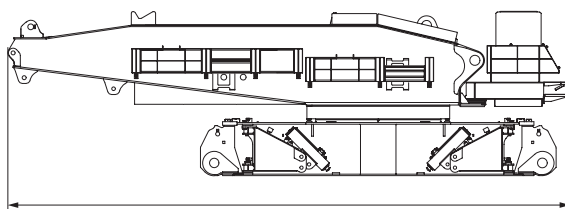

Weight	51,500 kg
Width	3.0 m
Height	3.4 m
(Machine)	
Length	11.67 m

Upper Structure

Upper Structure (1)

Upper structure with mast and upper connecting devices.

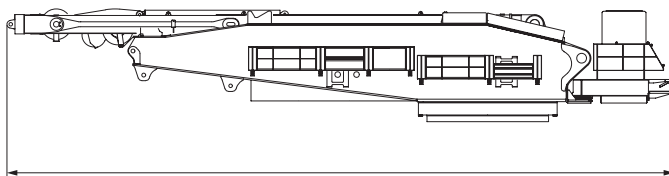

Weight	45,300 kg
Width	3.0 m
Height	2.37 m
(Machine)	
Length	14.25 m

Upper Structure (2)

Upper structure and upper connecting devices without mast.

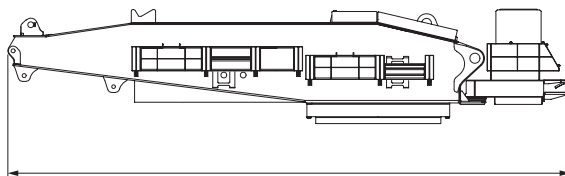

Weight	32,000 kg
Width	3.0 m
Height	2.37 m
(Machine)	
Length	11.67 m

Attachments

With
1 x 12 m insert boom
1 x 12 m insert jib
2 x counterweights

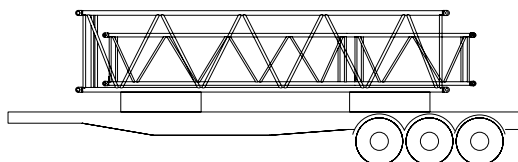

Weight	29,300 kg
Width	3.0 m
Height	2.9 m
(Boom)	

Upper translifter: 2,400 kg
Lower translifter: 2,300 kg
Upper connecting device: 900 kg
Lower connecting device: 2,500 kg

PARTS AND ATTACHMENTS

Dimensions: mm Weight: kg

Base Machine

With mast and lower transferter without upper/lower connecting devices.
Weight: 64,000 kg Width: 3,000 mm

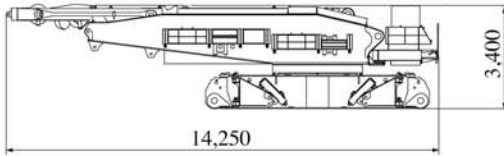

Carbody

With upper/lower connecting devices.
Weight: 22,610 kg Width: 2,990 mm

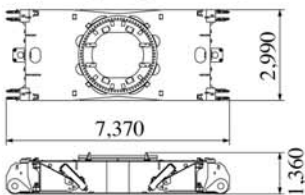

Crawler

Weight: 40,000 kg Width: 1,500 mm

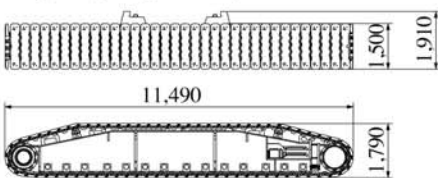

Crane Mast (Standard)

Weight: 12,460 kg

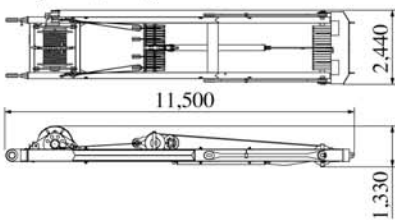

6 m Insert Boom

With 6 m guy line x 4
Weight: 3,760 kg

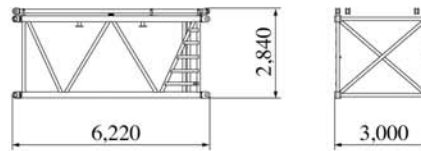

12 m Insert Boom

With 12 m guy line x 4
Weight: 6,570 kg

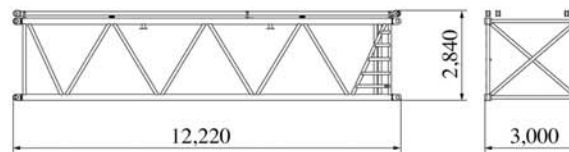

8 m Tapered Boom

With 8 m guy line x 2
Weight: 5,150 kg

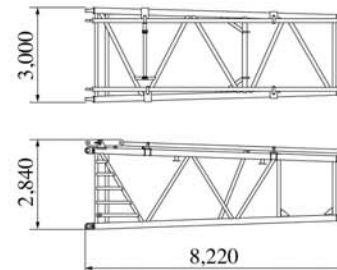

9 m Boom Base

With H1, H2 and W2 winches including ropes, guide sheave, and boom backstop
Weight: 29,280 kg

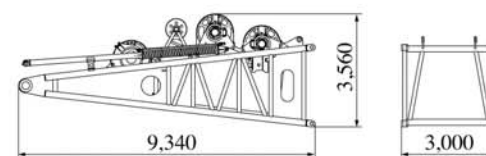

Heavy Boom Top

Weight: 4,910 kg

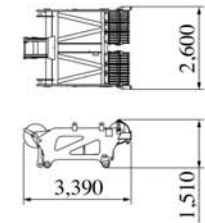

Luffing Boom Top

Weight: 5,520 kg

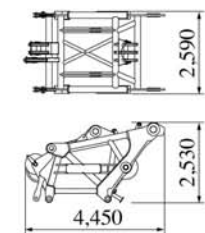

Base Counterweight

Weight: 20,000 kg

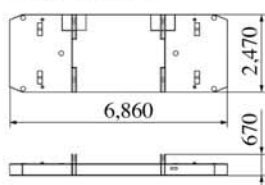

Counterweight

Weight: 10,000 kg

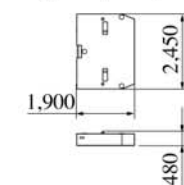

Base Carbody Weight

Weight: 5,400 kg



Base Pallet Weight

Weight: 11,000 kg

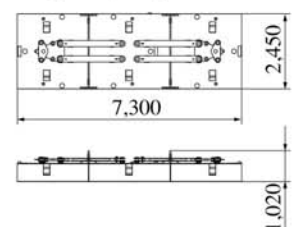

Dimensions: mm Weight: kg

10 m Jib Base

Weight: 3,780 kg

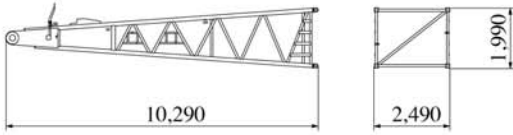

6 m Insert Jib

Weight: 1,470 kg

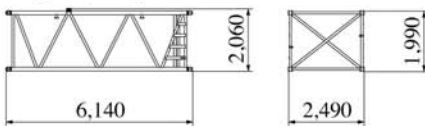

12 m Insert Jib

Weight: 2,680 kg

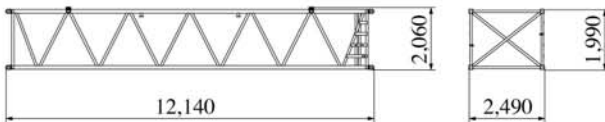

8 m Jib Top

Weight: 3,690 kg

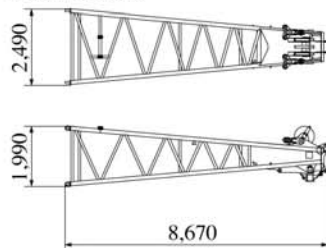

Strut (For Heavy Fixed Jib)

With guy cable
Weight: 1,510 kg

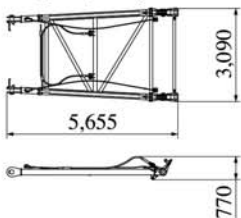

9 m Mast Base

Weight: 13,700 kg

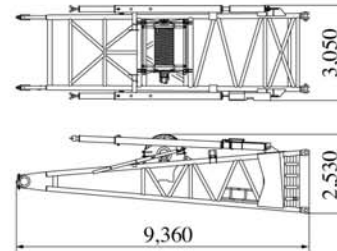

12 m Insert Mast

With guy line
Weight: 5,650 kg

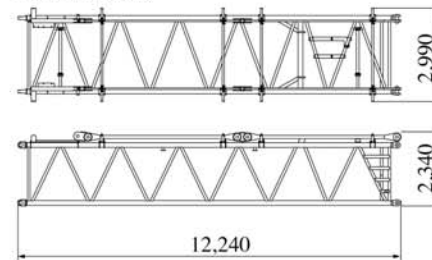

10 m mast top

With guy line
Weight: 10,080 kg

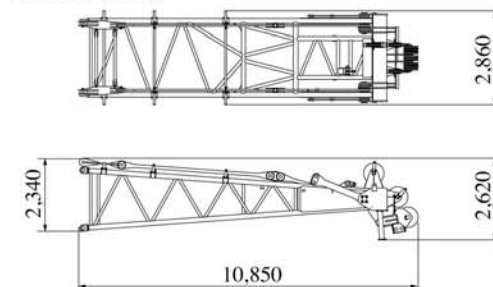

Other Attachments

Attachments	Weight	Dimensions (L x W x H)
Hanger sheave	2,010 kg	2,760 mm x 2,130 mm x 760 mm
5 m insert boom for long boom	1,790 kg	5,180 mm x 2,490 mm x 2,230 mm
Rear strut base	1,990 kg	6,820 mm x 2,590 mm x 1,620 mm
Rear strut top	2,410 kg	7,060 mm x 1,530 mm x 1,390 mm
Front strut base	1,840 kg	7,460 mm x 1,640 mm x 1,330 mm
Front strut top	3,040 kg	8,080 mm x 1,530 mm x 2,090 mm
Auxiliary sheave	650 kg	2,380 mm x 1,130 mm x 910 mm

Note: Estimated weights may vary ± 2%.

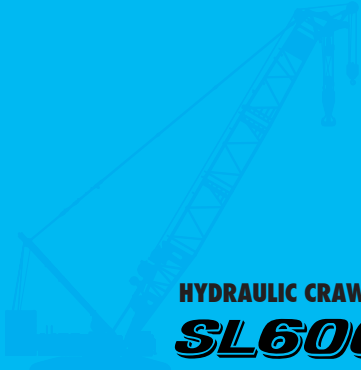

HYDRAULIC CRAWLER CRANE
SL6000

Note: Standard equipment may vary depending on your areas or countries.

Due to our policy of continual product improvements all designs and specifications are subject to change without advance notice.

Copyright by KOBELCO CRANES CO., LTD. No part of this catalog may be reproduced in any manner without notice.



KOBELCO CRANES CO., LTD.

17-1, Higashigotanda 2-chome, Shinagawa-ku, Tokyo 141-8626 JAPAN

Tel: +81-3-5789-2130 Fax: +81-3-5789-3372

URL: <http://www.kobelco-cranes.com/>

Inquiries To:

KOBELCO is the corporate mark used by Kobe Steel on a variety of products and in the names of a number of Kobe Steel Group companies.