

Manitowoc 2250

Product Guide



Features

- 1300 t (1,433 USt) capacity with RINGER® attachment
- 450 t (500 USt) capacity with MAX-ER® attachment
- 272 t (300 USt) capacity
- 91,4 m (300 ft) heavy-lift boom
- 112,8 m (370 ft) fixed jib on heavy-lift boom
- 122 m (400 ft) luffing jib on heavy-lift boom



Features

EPIC®

Manitowoc's field-proven Electronically Processed Independent Controls (EPIC) system delivers high productivity and precise load control by instantly matching an operator's commands to the crane function. EPIC's microprocessor maximizes a Manitowoc crane's function capability and simplifies servicing by pinpointing any problem in the crane's engine, power transmission and other operating systems. In addition, EPIC increases versatility by easily tailoring a Manitowoc crane's operation for specialized applications, with or without attachments. EPIC is a key reason no other crane can match the performance and reliability of Manitowoc.



FACT™ Connectors

Manitowoc's patented Fast Aligning Connection Technology (FACT) automatically aligns crane components for fast, easy assembly with increased safety.

Hydraulics

Our closed-loop system provides a separate hydraulic circuit to power each crane function and increase productivity. The result is truly independent variable-speed operation of the swing, load hoist, boom hoist and travel functions.

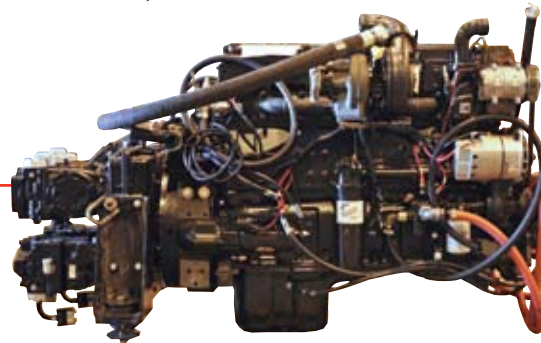

Crawler drive shafts

The crawler drive shafts prevent contaminants from entering the system. By eliminating the need to disconnect hydraulic systems, crawler removal and assembly is safer and easier.

Contents

Specifications	5
Outline dimensions	12
Transport data / assembly	18
Performance data	20
Boom combinations	28
Main boom range / load charts	31
Long-reach boom range / load charts	33
Fixed jib boom range / load charts	35
Luffing jib boom range / load charts	41
Fixed jib on luffing jib boom range / load charts	45
MAX-ER® 2000 complete information	49
M-1200 RINGER® complete information	88
Elevated cab, container handling	100
Manitowoc Crane Care	103

Notes

Specifications

Upperworks



Engine

Cummins Model QSX15-C500 diesel, 6 cylinder, 372 kW (500 BHP) @ 2100 governed RPM.

Includes engine block heater (120 V), ether starting aid, alcohol injector in air line, disconnect clutch for cold weather starting, high silencing muffler, hydraulic oil cooler, radiator and fan.

Multiple hydraulic pump drive transmission provides independent power for all machine functions.

Two 12 volt maintenance-free, Group 8D batteries, 1155 CCA at -18°C (0° F), 24 volt starting and 120 amp alternator.

One 644 l (170 gal) capacity diesel fuel tank, mounted on rear of upperworks, with level indicator in operator's cab.

➤ Optional: Cold-weather package with heater for fluids, brake pedals, batteries, and computer display.



Controls

Modulating electronic-over-hydraulic controls provide infinite speed response directly proportional to control lever movement. Controls include Manitowoc's exclusive EPIC® Electronically Processed Independent Control system providing microprocessor driven control logic, pump control, on-board diagnostics, and service information.

Block-up limit control is standard for hoist and whip lines.

Integrated Rated Capacity Limiter system (RCL) is standard for main boom and upper boom point. "Function cut-out" or "warning only" operation is selected via a keyed switch on the RCL console.



Hydraulic system

Six high-pressure piston pumps, driven by a multi-pump transmission, provide independent closed-loop hydraulic power for the hoisting drums, boom hoist, swing, left crawler and right crawler.

Hydraulic reservoir has 424 l (112 gal) capacity and is equipped with breather, clean out access, and internal diffuser.

Each function is equipped with relief valves to protect the hydraulic circuit from overload or shock.

System includes oil cooler and replaceable, spin-on, ten-micron full flow filter. All oil is filtered before entering the hydraulic pumps.

<u>System</u>	<u>kg/cm² (psi)</u>	<u>lpm (gpm)</u>
Hoisting Drums	422 (6,000)	598 (158)
Boom Hoist and Auxiliary Drum	422 (6,000)	299 (79)
Swing	422 (6,000)	299 (79)
Left Crawler	422 (6,000)	299 (79)
Right Crawler	422 (6,000)	299 (79)

➤ Optional: Independent front drum – 422 kg/cm² (6,000 psi) at 598 lpm (158 gpm) powered by travel pumps.

➤ Optional: Double-motor swing system – 422 kg/cm² (6,000 psi) at 299 lpm (79 gpm).



Drums

Basic machine is equipped with a split rear drum shaft assembly. Right drum is 1 140 mm (44-9/10") wide and 572 mm (22-1/2") diameter. Left drum is 480 mm (18-9/10") wide and 572 mm (22-1/2") diameter. Drum shaft is antifriction bearing mounted and is driven by a variable-displacement hydraulic motor through a planetary reduction. Internal-expanding drum clutches are spring set, air released. External-contracting drum brakes are air applied, spring released. Parking brakes are spring set, air released. Drum rotation indicator is standard for each drum. Operator may select free-fall or powered lowering mode using a selector switch.

➤ Optional: Two equal-split rear drums in place of standard drums. Each drum is 810 mm (31-9/10") wide and 572 mm (22-1/2") diameter.

➤ Optional: Interlock that permits split rear drums to be used as single drum with two brakes. Recommended for concrete bucket operations.

➤ Optional: Hydraulically powered auxiliary front drum 572 mm (22-1/2") diameter, 1 140 mm (44-9/10") wide rated at 133,4 kN (30,000 lb) line pull.

Specifications

For liftcrane, 963 mm (37.9") wide lagging provided. Drum shaft anti-friction bearing mounted on rotating bed. Drum anti-friction bearing mounted on shaft and equipped with internal-expanding clutch, external-contracting brake, and drum-rotation indicator. Includes third-drum control system. Bail limit is optional.

- Optional: Other drum sizes, laggings, and additional drums.
- Optional: Wire rope for various applications.



Boom hoist

Independent boom hoist with two grooved drums, each 505 mm (19-7/8") wide and 584 mm (23") diameter. Includes 297,2 m (975') of (1") diameter wire rope for reeving 12 part boom hoist line.

Drums are powered by a variable-displacement hydraulic motor coupled to an integral brake and a planetary reduction gearbox. Ratcheting pawl and rotation indicator are standard.

Boom hoist speed: raise 91,4 m (300') full main boom from 0° - 82° in 2 minutes, 40 seconds.



Swing system

High strength fabricated steel alloy rotating bed is mounted on 2,95 m (9' 8") diameter triple-row roller bearing turntable.

Rotating bed's upper and lower modules are fabricated steel and connected by four power actuated pins. Hydraulic connection of upper and lower modules is made through H-FACT® hydraulic quick coupler. Enclosures are included on both sides of upper module.

Independent swing powered by a fixed displacement hydraulic motor coupled to a planetary reduction gearbox with internal brake. 360° positive swing lock.

Swing system maximum speed: 1.8 rpm.



Boom support system

The 8,5 m (28') long retractable gantry provides the geometry to raise and support all combinations of boom and jib. The telescoping square-tube backhitch is equipped with power actuated locking pins.

Boom-hoist rope reeved through sheaves in the gantry and equalizer forms 12-part boom-hoist rigging, and high-strength steel straps connect the equalizer to the boom top.

Air cushioned boom stop and automatic boom stop are standard.

Gantry includes hydraulic raising cylinders capable of lifting the upperworks counterweight for installation and removal. Counterweight attaches to rotating bed with power actuated pins.



Counterweight

Qty.	Item	Unit Weight		Total Weight	
		kg	lb	kg	lb
1	Upperworks Tray	17 781	39,200	17 781	39,200
1	Center Box	16 783	37,000	16 783	37,000
6	Lower Side Box	7031	15,500	42 186	93,000
Series 1 total				76 750	169,200
2	Upperworks Upper Side Box	9072	20,000	18 144	40,000
2	Carbody Center Box	13 608	30,000	27 216	60,000
Optional: Add to Series 1 for Series 2 total				122 110	269,200
2	Upperworks Upper Side Box	9 072	20,000	18 144	40,000
4	Carbody Side Box	6804	15,000	27 216	60,000
Optional: Add to Series 2 for Series 3 total				167 470	369,200

Includes connecting pins, brackets, and stops.



Operator's cab

Fully enclosed and insulated steel module mounted at left front corner of rotating bed on a pivoting frame that permits cab to be repositioned for transportation. Module is equipped with sliding door, large safety glass windows on all sides and roof. Signal horn, cab space heater, front and roof windshield wipers, dome light, sun visor and shade, fire extinguisher, air circulating fan, swing and travel alarms, air conditioning for operator's cab and anemometer (wind indicator) are standard.

- Optional: Nylon protective window covers.
- Optional: 10,7 m (35') elevated cab, 1 320 mm (52") wide, with catwalks and railing.

Specifications

Attachments



No. 44 Boom with heavy-lift top

The liftcrane is equipped with a 21,3 m (70') No. 44 angle-chord boom consisting of a two-piece 12,2 m (40') butt and a 9,1 m (30') heavy-lift top with nine 762 mm (30") diameter roller bearing sheaves on one shaft. Includes rope guides, boom angle indicator, and a 594 kg (1,310 lb) hook and weight ball. The No. 44 boom utilizes steel suspension straps and Manitowoc's patented, exclusive FACT™ connection system consisting of two vertical pins, two horizontal connection pins, and alignment pads for each boom connection location. Because the 2250 uses steel-strap rigging, boom inserts from the M-250 cannot be used on the 2250.

Luffing jib preparation is standard.

- Optional: 3,0 m (10'), 6,1 m (20'), and 12,2 m (40') No. 44 boom inserts with steel boom suspension straps, and FACT™ connection system.
- Optional: Intermediate suspension, required for boom lengths of 85,3 m (280') or more.
- Optional: Detachable upper boom point with one 762 mm (30") diameter tapered roller bearing steel sheave with rope guard, for liftcrane use on heavy-lift and long-reach boom tops. (Same upper point used on Models 777, 777T, 888, and M-250.)



No. 44 Long reach boom top

➤ Optional: 21,3 m (70') long reach top consisting of 9,1 m (30') transition insert and 12,2 m (40') top with three 762 mm (30") diameter straight-roller-bearing sheaves. Includes steel rigging straps, wire rope guide, and hardware for RCL.

FACT™ connectors at lower end of transition insert enable mounting to standard No. 44 boom inserts. Transition insert can be purchased with FACT™ or pin connectors at top, permitting either No. 133A (pinned) or No. 133 (FACT™) luffing jib top to also be used as long-reach top for No. 44 boom.

- Optional: Intermediate suspension, required for boom lengths of 91,4 m (300') or more.



No. 132 Fixed jib

➤ Optional: 12,2 m (40') basic No. 132 fixed jib consists of 6,1 m (20') butt and 6,1 m (20') top, with 6,1 m (20') strut, pendants, backstay, and RCL hardware.

➤ Optional: No. 132 fixed jib 6,1 m (20') inserts with pendants for total jib lengths to 36,6 m (120').

Use on Boom No. 44 with heavy-lift or long-reach boom top.



No. 133A Luffing jib

➤ Optional: 21,3 m (70') basic No. 133A (pin connected) luffing jib with RCL hardware consists of 9,1 m (30') butt and 12,2 m (40') top with three 762 mm (30") roller bearing sheaves and basic pendants, fixed strut, jib strut, backstay pendants, boom point guide wheel, luffing jib hoist with ratcheting pawl, quick-disconnect for luffing jib hoist piping, (7/8") luffing jib hoist line, and 476 mm (18-3/4") diameter grooved luffing drum.

➤ Optional: 3,0 m (10'), 6,1 m (20'), and 12,2 m (40') No. 133A inserts with pendants for total jib lengths to 61,0 m (200').

➤ Optional: Parts for outside-assist raising (where code permits).



No. 140 Fixed jib

➤ Optional: Basic 12,2 m (40') No. 140 fixed jib consists of 6,1 m (20') butt and 6,1 m (20') top, with 6,1 m (20') strut, pendants, backstay, and RCL hardware.

➤ Optional: No. 140 fixed jib inserts 6,1 m (20') with pendants for total jib lengths to 36,6 m (120').

Use on No. 133A or 133 luffing jib.

➤ Optional: Parts to convert No. 132 fixed jib to No. 140 fixed jib.

Specifications



MAX-ER® 2000

Components to make up 36,6 m (120') No. 79 boom including one 9,1 m (30') No. 79 boom butt, one 6,1 m (20') No. 79 boom insert, one 12,2 m (40') No. 79 boom insert with equalizer platform, one 7,6 m (25') No. 79 transition insert, one 1,52 m (5') No. 79 boom top (15 sheaves), deflector sheave assembly (3 sheaves), boom equalizer (5 sheaves), steel rigging straps, and RCL hardware for No. 79 boom top.

Automatic boom stop, air-cushioned physical boom stop, and 793 m (2,600') of boom hoist wire rope (can be used as load line on 2250 crane). Components to make up 39,6 m (130') No.44 mast including one 12,2 m (40') No.44 mast butt, one 12,2 m (40') No.44 mast top (5 sheaves), physical mast stop, wire rope guide, and steel rigging straps.

Note: Requires use of 3,0 m (10') No. 44 boom insert and 12,2 m (40') No. 44 boom insert from 2250 liftcrane.

Main hoist drum assembly grooved for 29 mm or (1-1/8") wire rope mounted in No. 79 boom butt.

Integrated boom and mast adaptor frame.

Note: 2250 liftcrane requires MAX-ER 2000 preparation, Series 2 counterweights on carbody, and Series 1 counterweights on upperworks.

Note: The MAX-ER 2000 attachment cannot be used on an existing model 2250 liftcrane without modification, and cannot be used on M-250 model.

The MAX-ER 2000 attachment uses up to 209 560 kg (462,000 lb) of MAX-ER counterweight supported on a carrier behind the basic crane. The MAX-ER counterweight is attached to the top of the mast by straps and to the rear of the 2250's upperworks by an adaptor arm and trailer arm inserts.

The MAX-ER counterweight can be carried by a hanging counterweight tray or a wheeled counterweight carrier.

The wheeled counterweight carrier uses eight large off-road vehicle tires, which can be positioned for traveling, crabbing, or swinging. It also includes hydraulic support jacks and pads.

Either counterweight assembly can be positioned 9,14 m (30'); 12,2 m (40'); or 15,2 m (50') behind the 2250's centerline of rotation to meet the capacity requirements of an individual lift.

Item	Qty.	Unit Weight		Total Weight	
		kg	lb	kg	lb
Wheeled Carrier	1	34 609	76,300	34 609	76,300
Counterweight Boxes					
Lower Side*	12	5897	13,000	70 760	156,000
Lower Center**	6	6441	14,200	38 646	85,200
Upper Side - Right***	2	9072	20,000	18 144	40,000
Upper Side - Left***	2	9072	20,000	18 144	40,000
Upper Center*	4	6804	15,000	27 216	60,000
Adaptor Plate - Front	2	454	1,000	907	2,000
Adaptor Plate - Rear	2	502	1,106	1 003	2,212
Miscellaneous parts	1	131	288	131	288
				209 560	462,000

* Optional: 8 each 8845 kg (19,500 lb).

** Optional: 4 each 9639 kg (21,250 lb).

***From Model 2250 Series 3 Crane.

➤ Optional: 12,2 m (40') No. 79 boom insert with stowable steel rigging straps and wire rope guides, one required in boom rigging for all boom lengths over 36,6 m (120').

➤ Optional: 12,2 m (40') No. 79 boom insert with stowable steel rigging straps for boom lengths over 48,8 m (160') up to 109,7 m (360').

➤ Optional: 4,6 m (15') No. 79-44 transition insert with wire rope guide and stowable steel rigging straps for use of No. 44 boom insert(s) and top for long-reach boom.

➤ Optional: No. 44 luffing jib. Components to make up 21,3 m (70') basic luffing jib include a 15,2 m (50') jib strut with 7 sheaves, 14,3 m (47') main strut with 7 sheaves, jib strut stop, luffing jib stop, main luffing strut backstay straps, basic luffing jib steel rigging straps, combination upper point and luffing jib raising wheel, luffing drum assembly, 549 m (1,800') luffing drum wire rope, and wire rope guide(s) as required.

Note: Basic luffing jib utilizes 12,2 m (40'), No. 44 boom butt and 9,1 m (30') No. 44 boom top from 2250 liftcrane. Luffing jib also uses No. 44 boom inserts and straps from 2250 liftcrane for luffing jib lengths greater than 21,3 m (70').

➤ Optional: 408-mton (450-ton) load block with duplex hook.

➤ Optional: 227-mton (250-ton) load block with duplex hook.

➤ Optional: Liftcrane load line 29 mm or (1-1/8") rotation resistant.

➤ Optional: Components to allow for self-assembly of boom and other components utilizing mast, boom hoist drum, and boom equalizer.

Specifications



M-1200 RINGER®

18,3 m (60') diameter ring structure with wear plates, crawler side frame attaching beams and "RINGER-SWINGER®" gear segments.

RINGER support pedestals with manual screw style adjustments.

Hydraulic jacking system, including jacks, controls and ring leveling gauge.

Boom carrier with boom and mast hinge pins. Carrier includes mounting for Model M-1200 hoist drum.

Counterweight carrier with attachment beams to machine rear and counterweight lift indicator in operator's cab.

➤ Optional: 714 811 kg (1,577,600 lb) of counterweight for 800-mton (900-ton) rating.

➤ Optional: 914 175 kg (2,017,000 lb) of counterweight for 1 300-mton (1,433-ton) rating.

No. 75A boom attachment 800-mton (900-ton) capacity

45,7 m (150') No. 75A basic boom, including 15,2 m (50') No. 75A butt, 15,2 m (50') No. 75A insert and 15,2 m (50') No. 75 top.

45,7 m (150') No. 75A mast including 7,6 m (25') No. 75 mast butt, two 15,2 m (50') No. 75A inserts, 7,6 m (25') No. 75 mast top, b straps and backhitch straps.

Mast self-erect system, steel strap rigging, equalizer, and boom hoist wire rope for 32-part boom hoist reeving for No. 72 boom.

Air-cushioned physical boom stop, air automatic boom stop, boom angle indicator.

No. 75A 800-mton (900-ton) boom point with sixteen 1067 mm (42") diameter sheaves grooved for (1-5/8") diameter rope.

RINGER® travel assist system.

Two "RINGER-SWINGER®" assemblies.

Single-drum Model M-1200 hoist, complete with lagging grooved for (1-5/8") wire rope, hydraulic power provided by 2250 lifter, for load hoist drum.

➤ Optional: 7,6 m (25') and 15,2 m (50') No. 75 boom inserts and rigging straps for total boom lengths to 121,9 m (400').

No. 72A boom attachment

The following components must be added to the No. 75A boom attachment to achieve a No. 72A lifter attachment for the M-1200 RINGER.

Conversion to two drum M-1200 hoist [each drum includes lagging grooved for (1-5/8") wire rope], including additional Cummins N14-C450 diesel engine rated at 335 kW (450 HP), which supplements total load hoist and swing capability.

46,6 m (153') No. 72A boom, including 15,2 m (50') butt, one 15,2 m (50') insert and 15,2 m (50') transition insert with 0,9 m (3') boom top/jib adaptor. Strap rigging, equalizer and boom hoist wire rope for 36-part reeving in place of 32-part reeving.

Two additional "RINGER-SWINGER®" assemblies and interconnecting piping.

➤ Optional: 7,6 m (25') and 15,2 m (50') No. 72A boom inserts and rigging straps for total boom lengths to 122,8 m (403').

➤ Optional: (1-5/8") wire rope for load line and (1-1/8") wire rope for whip line.

➤ Optional: 1 300-mton (1,433-ton) lower point.

➤ Optional: 1 300-mton, (1,433-ton) load block with quad hook and hanger block.

➤ Optional: No. 72A to No. 75 boom picture frame insert for making No. 72A-75 combination boom.

The 914 175 kg (2,017,600 lb) of b required for 1 300-mton (1,433-ton) rating can be supplied by Manitowoc.

No. 75 Jib

➤ Optional: 30,4 m (100') No. 75 jib, backstay straps and rigging components utilizes No. 75 boom top and butt from 800-mton (900-ton) lift attachment and No. 44 boom from 2250 for jib strut.

➤ Optional: 7,6 m (25') and 15,2 m (50') No. 75 inserts and straps for total lengths up to 76,2 m (250').

MAX-RINGER™ suspended counterweight attachment

Suspended counterweight attachment consists of structural backhitch links at the No. 75A mast top, structural backhitch straps, and suspended counterweight tray. Counterweight for the suspended counterweight attachment will be quoted upon request or may be customer supplied.

Specifications

No. 182 structural fixed jib for No. 72A boom

Single piece 15,2 m (50') structural jib and jib strut pin to No. 72A boom top and utilize the 800-mton (900-ton) boom point from the No. 75 fixed jib. Rigging consists of structural straps, links and pins.

➤ Optional: Front auxiliary drum, with ratchet and pawl. Includes hydraulic piping and lifterane lagging grooved for (1-1/8") rope.

NOTE: Auxiliary drum cannot run simultaneously with M-1200 main hoist drums

➤ Optional: 80-mton (88-ton) upper boom point assembly for use with No. 75A boom, No. 72A boom, or No. 75 jib.

Consult Manitowoc Sales department for other options.

Lowerworks



Carbody

Connects rotating bed and crawler frames. Fabricated steel rotating bed lower module mounts to single-piece carbody by 2,9 m (9' 8") diameter triple-row roller bearing turntable. Each crawler frame is mounted to the carbody with FACT™ connection system power-actuated pins. Crawler drive motors are mounted on carbody. Permits crawler removal without opening travel drive hydraulic circuit.

Crawlers

Crawler assemblies are 9,40 m (30' 9") long with 1,22 m (48") wide cast steel crawler pads and sealed "low maintenance" intermediate rollers. Each crawler is powered independently by a variable displacement hydraulic motor. Carbody mounted drive motors are connected to crawler final reduction via telescoping shafts. This permits crawlers to be removed without opening their hydraulic circuits. Crawlers provide ample tractive effort for counter rotation with full rated load.

Maximum ground speed of 1,61 kph (1.0 mph).

➤ Optional: 1 220 mm (48") wide flattened treads for 1 149 mm (45-1/4") hard surface bearing width [instead of 514 mm (20-1/4") bearing width of standard treads].

➤ Optional: 1 524 mm (60") wide treads (no self-erect option allowed).

Optional equipment

➤ Optional: Self-erect system, includes two wire rope guides for crawler handling, boom butt handling cylinder, upperworks jacking cylinders with pads, alignment device, four carbody support pedestals, 41-mton (45-ton) assembly block, crawler handling chains, 48,7 m (160') of (1-1/8") diameter rigging line.

➤ Optional: Blocks and Hooks, each with 762 mm (30") roller-bearing sheaves for 29 mm or (1-1/8") wire rope, a roller-bearing swivel hook, a hook latch, and a swivel lock.

13,6-mton (15-ton) swivel hook and weight ball

41-mton (45-ton) hook block with one sheave [assembly block]

54-mton (60-ton) hook block with two sheaves

91-mton (100-ton) hook block with three sheaves

272-mton (300-ton) hook block with nine sheaves and a duplex swivel hook

➤ Optional: Wire rope for various applications.

➤ Optional: Equipment and testing for special code compliance.

➤ Optional: Preparation for MAX-ER® 2000.

➤ Optional: Preparation for M-1200 RINGER®.

➤ Optional: Hydraulic Test Kit: required to properly analyze the performance of the EPIC® control system.

➤ Optional: Service Interval Kits: for the regularly scheduled maintenance of general crane operations.

➤ Optional: Lighting Packages: consult dealer for available options.

➤ Optional: Special Paint [color(s) other than Manitowoc standard red and black].

➤ Optional: Custom vinyl decal(s) of customer name and/or logo from artwork supplied by customer.

➤ Optional: Export Packaging: basic crane, boom and jib sections. MAX-ER® and RINGER® export packaging available.

Optional applications



No. 136 Container handling jib

Conversion from Liftcrane to No. 136 Container handling jib

Equal-split rear drum assembly, with two drums, each 810 mm (31-9/10") wide, in place of standard unequal-split rear drum. Liftcrane laggings for both drums, 810 mm (31-9/10") wide, 622 mm (24-1/2") in diameter and grooved for 29 mm or (1-1/8") rope. Tapered pins for rotating bed connection. Block up limit for No. 44 boom and No. 136 luffing jib. 24,4 m (80') No. 44 boom in place of 21,3 m (70') basic boom. 21,3 m (70') basic No. 136 luffing jib for layout assembly consisting of pin connected 6,1 m (20') jib butt, 15,2 m (50') top with two 762 mm (30") diameter sheaves spread 1 520 mm (60") apart to provide horizontal stability of the container, basic pendants, fixed strut, jib strut, backstay pendants, boom point guide wheel, luffing jib hoist with ratchet and pawl, and (7/8") luffing jib line. Hydraulic container tagline system. Slack-rope detection with visual and audible alarm in operator's cab. Two 27-mton (30-ton) single sheave hook blocks. Delete H-FACT® and power pins in rotating module. Delete Integrated Rated Capacity Limiter (RCL). Delete 594 kg (1,310 lb) hook and weight ball. Delete powered pins in crawlers.

Outline dimensions

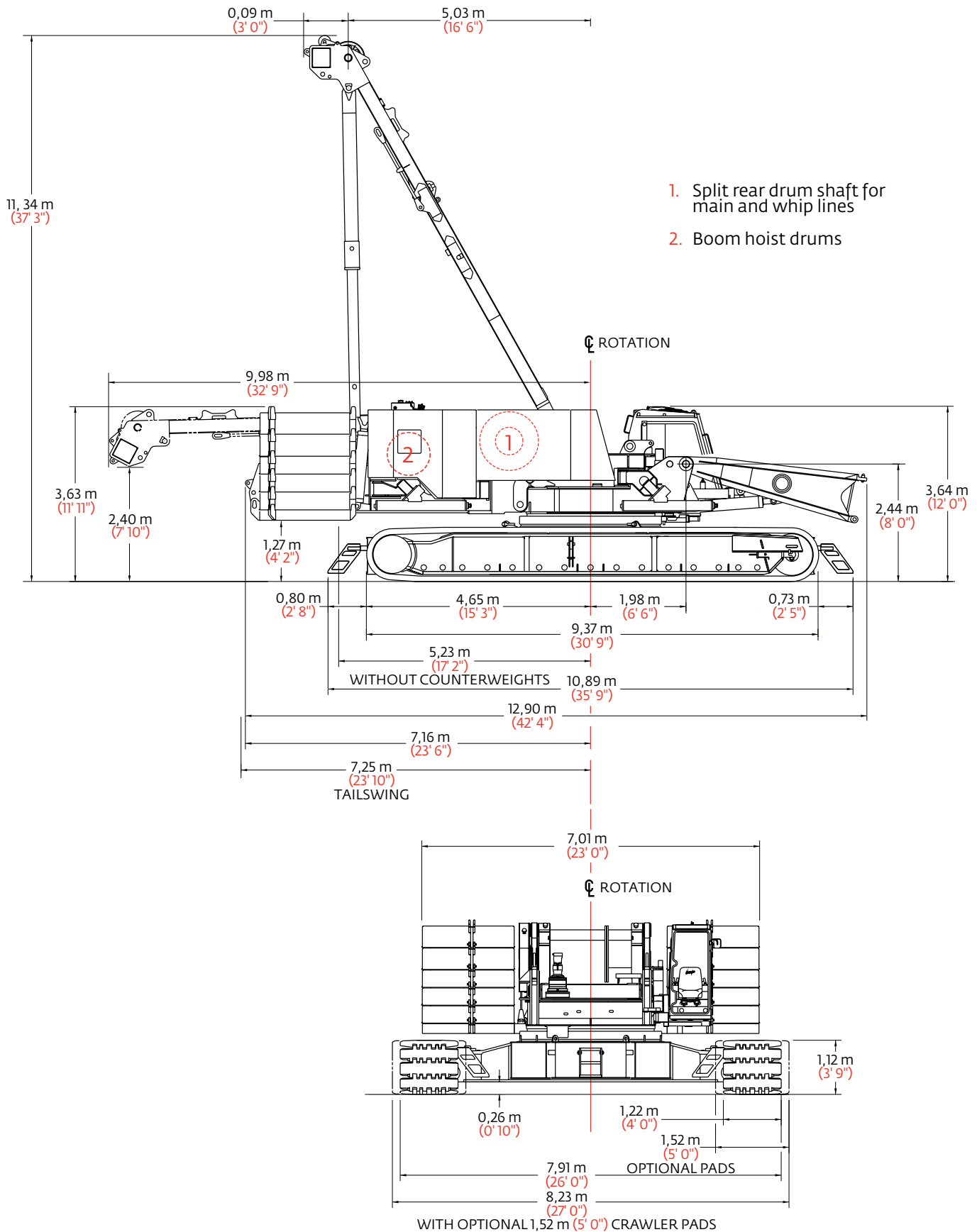

Outline dimensions

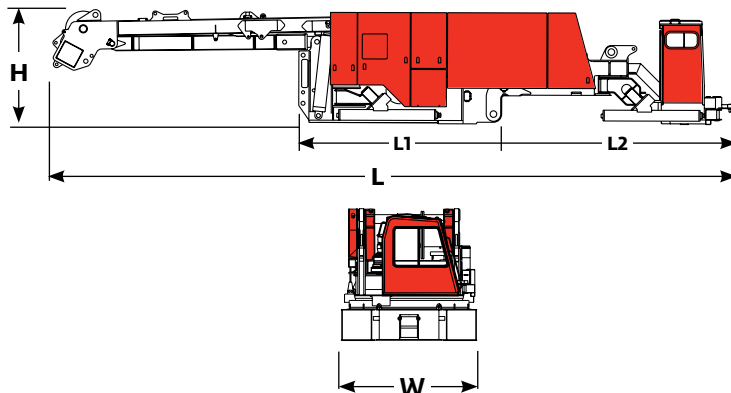

Upperworks module		x 1
Length	13,16 m	43' 2"
Width	3,00 m	9' 10"
Height	2,18 m	7' 2"
Weight	38 563 kg	85,020 lb

Note: Weight includes rotating bed rear section, diesel power plant, operator's cab, gantry, gantry lifting cylinders, boom hoist with wire rope, equalizer, split rear drum shaft with hoist and whip lines, optional self assembly jacks, full hydraulic fluid reservoir, and half tank of fuel. Length of L1 is 3,30 m (12' 10") and L2 is 4,51 m (14' 9,5").

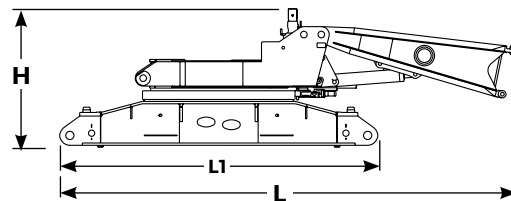

Carbody, rotating module and lower boom butt 3,7 m (12')		x 1
Length	8,81 m	28' 11"
Width	2,95 m	9' 8"
Height	2,63 m	8' 8"
Weight	29 187 kg	64,350 lb

Note: Weight includes turntable bearing, one swing drive, rotating union, 3,7 m (12' 0") lower boom butt, optional boom-butt handling cylinder, and four carbody support pedestals. Length of L1 is 6,14 m (20' 2").

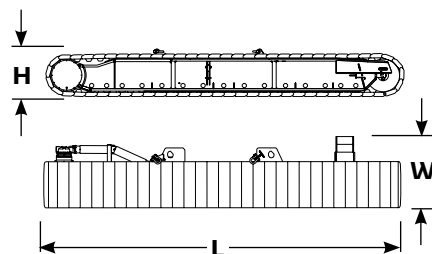

Crawlers		x 2
Length	9,37 m	30' 9"
Width	2,21 m	7' 3"
Height	1,26 m	4' 2"
Weight	24 412 kg	53,820 lb

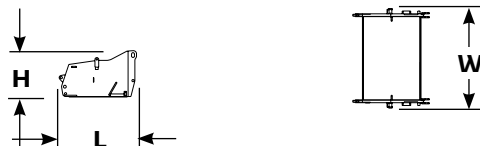

Upper center counterweight		x 1
Length	2,08 m	6' 10"
Width	2,72 m	8' 11"
Height	1,27 m	4' 2"
Weight	16 782 kg	37,000 lb

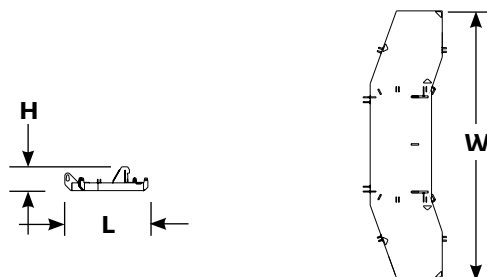

Counterweight tray		x 1
Length	2,19 m	7' 2"
Width	6,99 m	22' 11"
Height	0,64 m	2' 1"
Weight	17 742 kg	39,115 lb

Note: Weight includes lifting frames.



Side counterweight		x 6
Length	2,01 m	6' 7"
Width	1,93 m	6' 4"
Height	0,48 m	1' 7"
Weight	7 030 kg	15,500 lb

Note: Three each of left- and right-side configurations required.

Option

Outline dimensions



Side counterweight		
Series 2, 3		x 2, 4
Length	2,01 m	6' 7"
Width	1,93 m	6' 4"
Height	0,58 m	1' 11"
Weight	9 071 kg	20,000 lb
<i>Note: Left- and right-side configurations are required.</i>		

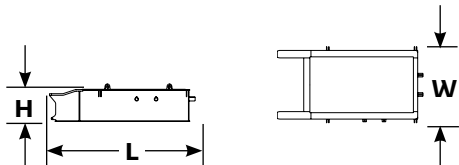

Carbody center counterweight		
Series 2, 3		x 2
Length	3,45 m	11' 4"
Width	1,80 m	5' 11"
Height	0,89 m	2' 11"
Weight	13 607 kg	30,000 lb



Carbody side counterweight		
Series 3		x 4
Length	2,18 m	7' 2"
Width	0,86 m	2' 10"
Height	0,89 m	2' 11"
Weight	6 803 kg	15,000 lb

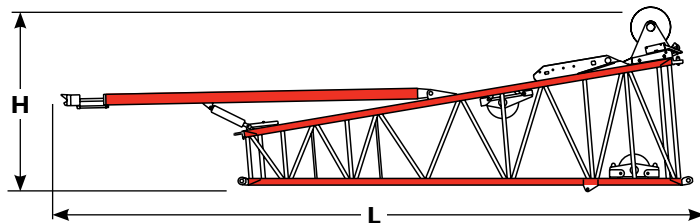

No. 44 Upper boom butt 8,5 m (28') and wire rope guide, boom stop		x 1
Length	11,94 m	39' 2"
Width	2,59 m	8' 6"
Height	3,45 m	11' 4"
Weight	5 194 kg	11,450 lb

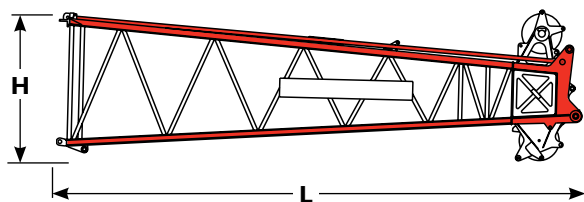

No. 44 Boom top 9,1 m (30') and wire rope guide, straps, lower point		x 1
Length	10,06 m	33' 0"
Width	2,59 m	8' 6"
Height	2,90 m	9' 6"
Weight	5 657 kg	12,475 lb

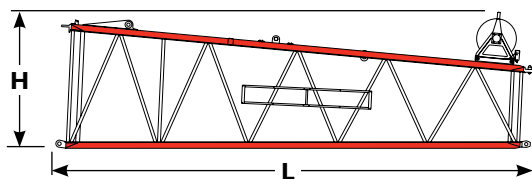

No. 44 Long reach transition insert 9,1 m (30') and wire rope guide, straps		x 1
Length	9,63 m	31' 7"
Width	2,59 m	8' 6"
Height	2,64 m	8' 8"
Weight	2 179 kg	4,805 lb

Note: Must specify if to be used with pin or FACT™ connections for long reach boom top.

Option

Outline dimensions

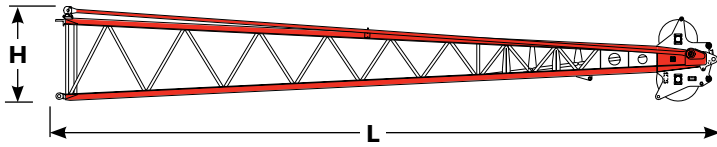

No. 44 Long reach boom top 12,2 m (40') and wire rope guide, lower point, straps			x 1
Length	13,06 m	42' 10"	
Width	2,08 m	6' 10"	
Height	1,83 m	6' 0"	
Weight	3 529 kg	7,785 lb	

Note: Can be used as No. 133A or No. 133 luffing jib top.

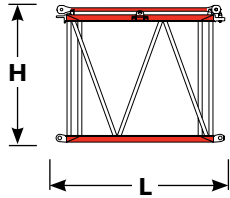

No. 44 Boom insert 3,0 m (10') and straps			x 1, 2
Length	3,23 m	10' 7"	
Width	2,59 m	8' 6"	
Height	2,59 m	8' 6"	
Weight	1 015 kg	2,240 lb	

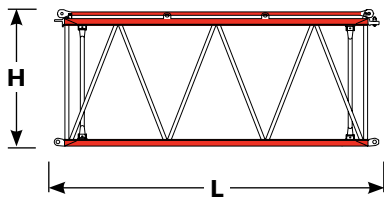

No. 44 Boom insert 6,1 m (20') and straps			x 1, 2
Length	6,28 m	20' 7"	
Width	2,59 m	8' 6"	
Height	2,59 m	8' 6"	
Weight	1 724 kg	3,805 lb	

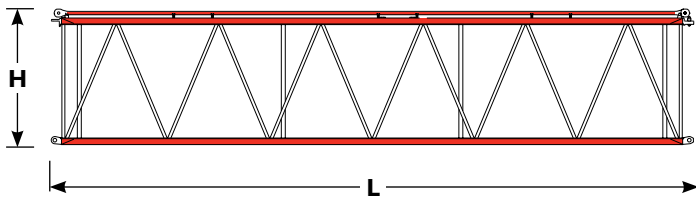

No. 44 Boom insert 12,2 m (40') and straps			x 1, 2, 3, 4, 5
Length	12,38 m	40' 7"	
Width	2,59 m	8' 6"	
Height	2,59 m	8' 6"	
Weight	2 946 kg	6,500 lb	
Light Weight	2 415 kg	5,330 lb	

Note: One light weight insert required for lengths above 82,3 m (270') with heavy-lift top or for lengths above 88,4 m (290') with long-reach top.

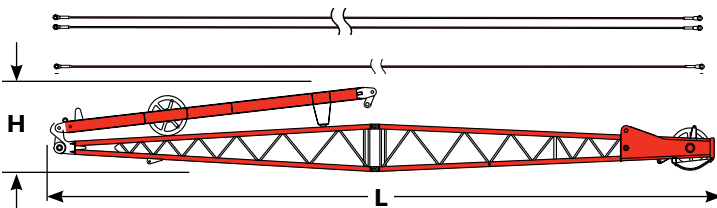

No. 132 Fixed jib 12,2 m (40') and strut, pendants			x 1
Length	12,78 m	41' 11"	
Width	1,22 m	4' 0"	
Height	1,60 m	5' 3"	
Weight	2 604 kg	5,740 lb	

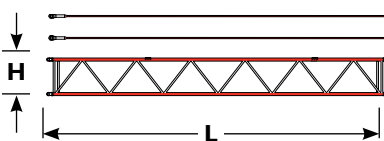

No. 132 Jib insert 6,1 m (20') and pendants			x 1, 2, 3, 4
Length	6,25 m	20' 6"	
Width	1,22 m	4' 0"	
Height	0,91 m	3' 0"	
Weight	466 kg	1,030 lb	

Option

Outline dimensions

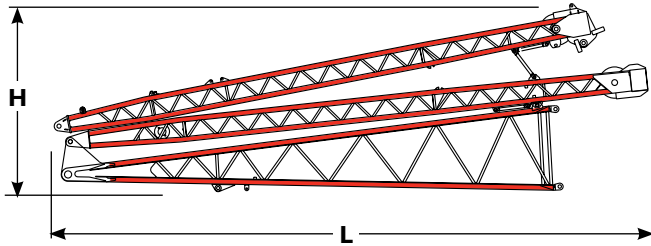

No. 133A or 133 Luffing jib butt 9,1 m (30') and struts			x 1
Length	11,21 m	36' 10"	
Width	2,07 m	6' 10"	
Height	3,46 m	11' 4"	
Weight	7793 kg	17,180 lb	

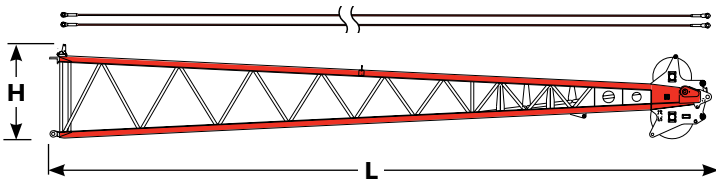

No. 133A or 133 Luffing jib top 12,2 m (40') and wire rope guide, lower point, pendants			x 1
Length	13,06 m	42' 10"	
Width	2,08 m	6' 10"	
Height	1,65 m	5' 5"	
Weight	3 649 kg	8,045 lb	

Note: Can be used as long-reach top for No. 44 boom when combined with No. 44 long-reach transition insert 9,1 m (30').

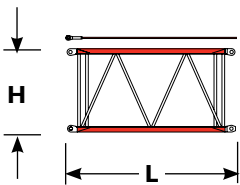

No. 133A or 133 luffing jib insert 3,0 m (10') and pendants			x 1
Length	3,18 m	10' 5"	
Width	2,07 m	6' 10"	
Height	1,65 m	5' 5"	
Weight	559 kg	1,235 lb	

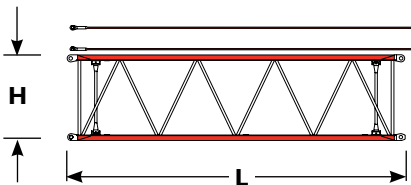

No. 133A or 133 Luffing jib insert 6,1 m (20') and pendants			x 1
Length	6,22 m	20' 5"	
Width	2,07 m	6' 10"	
Height	1,65 m	5' 5"	
Weight	960 kg	2,120 lb	

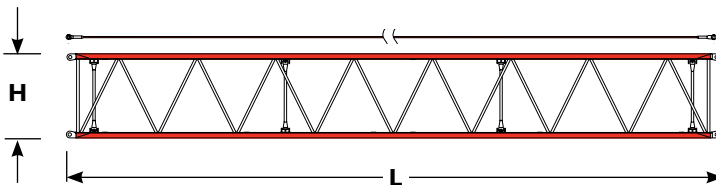

No. 133A or 133 Luffing jib insert 12,2 m (40') and pendants			x 1
Length	12,32 m	40' 5"	
Width	2,07 m	6' 10"	
Height	1,65 m	5' 5"	
Weight	1712 kg	3,780 lb	

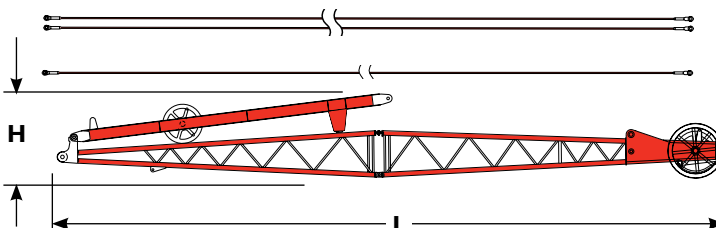

No. 140 Fixed jib 12,2 m (40') and strut, pendants			x 1
Length	12,78 m	41' 11"	
Width	1,22 m	4' 0"	
Height	1,63 m	5' 4"	
Weight	2 975 kg	6,558 lb	

Option

Outline dimensions

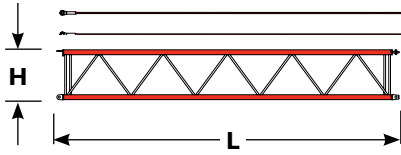

No. 140 Jib insert 6,1 m (20')			
and pendants			x 1, 2, 3, 4
Length	6,20 m	20' 4"	
Width	1,22 m	4' 0"	
Height	0,91 m	3' 0"	
Weight	467 kg	1 030 lb	

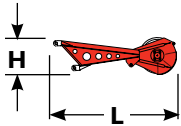

Upper boom point			x 1
Length	2,64 m	8' 8"	
Width	0,41 m	1' 4"	
Height	0,81 m	2' 8"	
Weight	421 kg	930 lb	

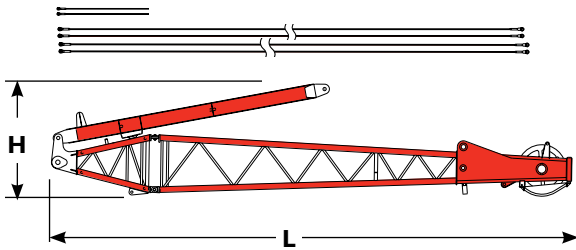

Extended upper boom point			x 1
6,1 m (25') and strut, pendants			
Length	8,28 m	27' 2"	
Width	1,22 m	4' 0"	
Height	1,80 m	5' 11"	
Weight	2 381 kg	5,250 lb	

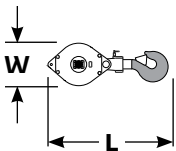

Hook block for 28 mm (1-1/8") wire rope					
Capacity	272 mt	300 t	Length	2,41 m	7' 11"
Weight	4 268 kg	9,410 lb	Width	1,14 m	3' 9"
Capacity	91 mt	100 t	Length	1,98 m	6' 6"
Weight	1 770 kg	3,900 lb	Width	0,89 m	2' 11"
Capacity	54 mt	60 t	Length	1,80 m	5' 11"
Weight	921 kg	2,030 lb	Width	0,89 m	2' 11"
Capacity	41 mt*	45 t*	Length	1,83 m	6' 0"
Weight	1 179 kg	2,600 lb	Width	0,91 m	3' 0"

*Assembly block

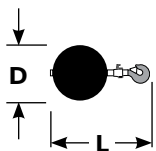

Weight ball					
Capacity/Swivel	13,5 mt	15 t	Diameter	0,46 m	1' 6"
Weight	594 kg	1,310 lb	Length	1,22 m	4' 0"

Option

Transport Data

Trailer load out summary																
Item	Weight each item Kg (lb)	Model 2250 Series 3 No. 132 Fixed jib 36,6 m (120') and No. 44 Boom 91,4 m (300')														
		Quantity on trailer load #														
		1	2	3	4	5	6	7	8	9	10	11	12	13	14	15
Upperworks module	38 563 (85,020)	1														
Carbody, rotating module and lower boom butt	29 187 (64,350)		1													
Crawler assembly	24 412 (53,820)			1	1											
Upper center counterweight	16 782 (37,000)										1					
Counterweight tray and lifting frames	17 742 (39,115)												1			
Side counterweight series 1, 2, 3	7 030 (15,500)									2	2	2				
Side counterweight series 2,3	9 071 (20,000)					1	1	1	1							
Carbody center counterweight series 2,3	13 607 (30,000)													1	1	
Carbody side counterweight series 3	6 803 (15,000)							1	1					1	1	
8,5 m (28') No. 44 Upper boom butt	5 194 (11,450)					1										
9,1 m (30') No. 44 Boom top and straps	5 657 (12,475)						1									
3,0 m (10') No. 44 Boom insert and straps	1 015 (2,240)												1			
6,1 m (20') No. 44 Boom insert and straps	1 724 (3,805)											1				
12,2 m (40') No. 44 Boom insert and straps	2 946 (6,500)							1	1	1*	1	1				
12,2 m (40') No. 132 Basic jib, strut & pendants	2 604 (5,740)										1**					
6,1 m (20') No. 132 Jib insert	466 (1,030)											2**	1	1		
272 mton (300 ton) Hook block	3 628 (8,000)						1									
41 mton (45 ton) Assembly hook block	1 179 (2,600)					1										
13,6 mton (15 ton) Weight ball	594 (1,310)					1										
No. 44 Upper boom point	421 (930)					1										
Miscellaneous	907 (2,000)					1				1						
Approximate total shipping weight kg (lb)		38 563 (85,020)	29 187 (64,350)	24 412 (53,820)	24 412 (53,820)	17 366 (38,290)	18 356 (40,475)	18 820 (41,500)	18 820 (41,500)	17 382 (38,330)	19 610 (43,240)	17 938 (39,560)	18 972 (41,835)	19 223 (41,385)	20 410 (45,000)	20 410 (45,000)

*12,2 m (40') No. 44 Light weight insert 2 417 kg (5,330 lb).

**Jib inside of 12,2 m (40') No. 44 insert.

Trailer configurations - (#1) 3 axle flat; (#2) 3 axle double drop 0,61 m (24") or lower; (#3-4) 3 axle step or flat; (#5) double drop; (#6-11) step deck; (#12-15) flat.

Crane assembly

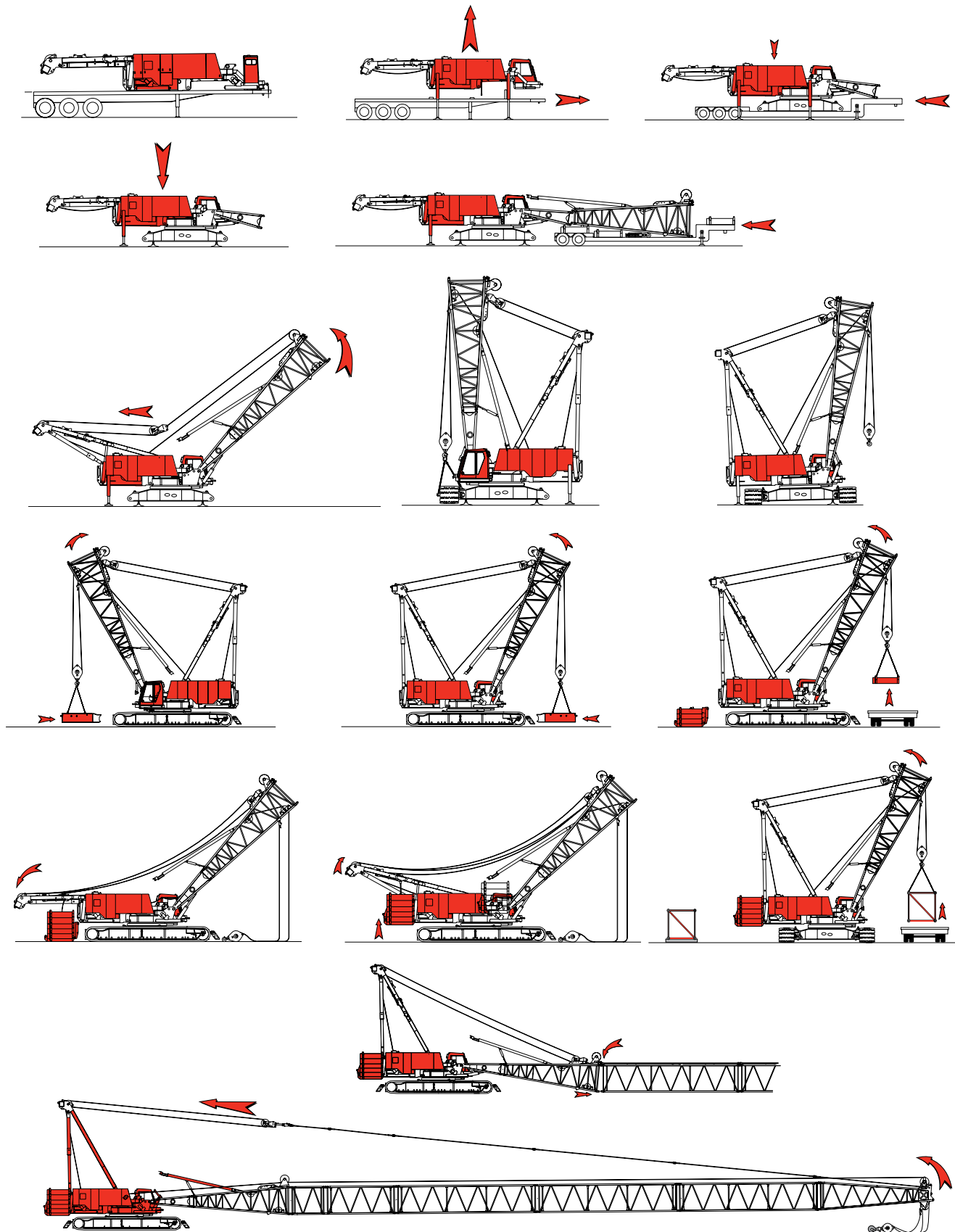

Note: Read the assembly folio in the operator's manual for a complete description of approved crane assembly procedures.

Performance data

Wire rope lengths
 Boom No. 44 with heavy-lift top
 - or -
 Fixed Jib No. 132 on
 Boom No. 44 with heavy-lift top

Boom or boom and fixed jib length m (ft)	Whip line Left rear or front drum								Hoist line Right rear drum		Maximum required parts of line
	(1 Part of line)		(2 Parts of line)		(3 Parts of line)		(4 Parts of line)		m	(ft)	
	m	(ft)	m	(ft)	m	(ft)	m	(ft)			
21,3 (70)	58	(190)	84	(275)	—	—	—	—	442	(1,450)	18
24,4 (80)	64	(210)	91	(300)	—	—	—	—	495	(1,625)	18
27,4 (90)	70	(230)	99	(325)	—	—	—	—	526	(1,725)	17
30,5 (100)	76	(250)	107	(350)	—	—	—	—	549	(1,800)	16
33,5 (110)	82	(270)	114	(375)	—	—	—	—	549	(1,800)	13
36,6 (120)	88	(290)	130	(425)	—	—	—	—	549	(1,800)	13
39,6 (130)	94	(310)	137	(450)	—	—	—	—	549	(1,800)	12
42,7 (140)	101	(330)	145	(475)	—	—	—	—	610	(2,000)	12
45,7 (150)	107	(350)	152	(500)	—	—	—	—	610	(2,000)	11
48,8 (160)	113	(370)	160	(525)	—	—	—	—	610	(2,000)	10
51,8 (170)	119	(390)	175	(575)	221	(725)	282	(925)	610	(2,000)	10
54,9 (180)	125	(410)	183	(600)	236	(775)	297	(975)	625	(2,050)	10
57,9 (190)	131	(430)	191	(625)	251	(825)	312	(1,025)	625	(2,050)	9
61,0 (200)	137	(450)	198	(650)	259	(850)	328	(1,075)	625	(2,050)	8
64,0 (210)	143	(470)	206	(675)	274	(900)	343	(1,125)	625	(2,050)	8
67,1 (220)	149	(490)	221	(725)	282	(925)	358	(1,175)	625	(2,050)	8
70,1 (230)	155	(510)	229	(750)	297	(975)	373	(1,225)	625	(2,000)	7
73,2 (240)	162	(530)	236	(775)	312	(1,025)	387	(1,270)	625	(2,050)	7
76,2 (250)	168	(550)	244	(800)	320	(1,050)	—	—	625	(2,050)	6
79,2 (260)	174	(570)	251	(825)	335	(1,100)	—	—	625	(2,050)	6
82,3 (270)	180	(580)	259	(850)	343	(1,125)	—	—	625	(2,050)	6
85,3 (280)	186	(610)	274	(900)	358	(1,175)	—	—	625	(2,050)	5
88,4 (290)	192	(630)	282	(925)	373	(1,225)	—	—	625	(2,050)	5
91,4 (300)	198	(650)	290	(950)	381	(1,250)	—	—	625	(2,050)	5
94,5 (310)	201	(660)	297	(975)	—	—	—	—	—	—	—
97,5 (320)	207	(680)	305	(1,000)	—	—	—	—	—	—	—
100,6 (330)	213	(700)	312	(1,025)	—	—	—	—	—	—	—
103,6 (340)	219	(720)	328	(1,075)	—	—	—	—	—	—	—
106,7 (350)	226	(740)	335	(1,100)	—	—	—	—	—	—	—
109,7 (360)	232	(760)	343	(1,125)	—	—	—	—	—	—	—
112,8 (370)	238	(780)	351	(1,150)	—	—	—	—	—	—	—

Note: Line lengths given in table will allow hook to touch ground. When block travel below ground is required, add additional rope equal to parts of line times added travel distance. Hoisting distance or line pull may be limited when block travel below ground is required. Maximum hook travel for upper boom point application may be restricted when whip line length exceeds 357 m (1,170') using 622 mm (24-1/2") diameter lagging on left rear drum.

Drums each provide 133 kN (30,000 lb) maximum single line pull.

Performance data

Wire rope lengths Luffing jib No. 133A or No. 133 on Boom No. 44 with heavy-lift top

Boom or boom and fixed jib length	Luffing jib Whip line		Luffing jib Hoist line											
	Left rear drum		Right rear drum when equipped with split rear drums Front drum when equipped with tandem drums											
	(1 Part of line)		(7 Parts of line)		(6 Parts of line)		(5 Parts of line)		(4 Parts of line)		(3 Parts of line)		(2 Parts of line)	
m (ft)	m	(ft)	m	(ft)	m	(ft)	m	(ft)	m	(ft)	m	(ft)	m	(ft)
45,7 (150)	104	(340)	389	(1,275)	—	—	—	—	—	—	—	—	—	—
48,8 (160)	110	(360)	419	(1,375)	—	—	—	—	—	—	—	—	—	—
51,8 (170)	116	(380)	434	(1,425)	—	—	—	—	—	—	—	—	—	—
54,9 (180)	122	(400)	465	(1,525)	404	(1,325)	—	—	—	—	—	—	—	—
57,9 (190)	128	(420)	488	(1,600)	427	(1,400)	366	(1,200)	—	—	—	—	—	—
61,0 (200)	134	(440)	511	(1,675)	450	(1,475)	389	(1,275)	—	—	—	—	—	—
64,0 (210)	140	(460)	541	(1,775)	472	(1,550)	404	(1,325)	—	—	—	—	—	—
67,1 (220)	146	(480)	—	—	488	(1,600)	419	(1,375)	358	(1,175)	—	—	—	—
70,1 (230)	152	(500)	—	—	511	(1,675)	442	(1,450)	373	(1,225)	—	—	—	—
73,2 (240)	158	(520)	—	—	—	—	457	(1,500)	389	(1,275)	—	—	—	—
76,2 (250)	165	(540)	—	—	—	—	472	(1,550)	396	(1,300)	320	(1,050)	—	—
79,3 (260)	171	(560)	—	—	—	—	495	(1,625)	411	(1,350)	335	(1,100)	—	—
82,3 (270)	177	(580)	—	—	—	—	511	(1,675)	427	(1,400)	343	(1,125)	—	—
85,3 (280)	183	(600)	—	—	—	—	533	(1,750)	442	(1,450)	358	(1,175)	—	—
88,4 (290)	189	(620)	—	—	—	—	—	—	457	(1,500)	373	(1,225)	—	—
91,4 (300)	195	(640)	—	—	—	—	—	—	472	(1,550)	381	(1,250)	—	—
94,5 (310)	201	(660)	—	—	—	—	—	—	488	(1,600)	396	(1,300)	—	—
97,5 (320)	207	(680)	—	—	—	—	—	—	—	—	404	(1,325)	—	—
100,6 (330)	213	(700)	—	—	—	—	—	—	—	—	419	(1,375)	—	—
103,6 (340)	219	(720)	—	—	—	—	—	—	—	—	427	(1,400)	—	—
106,7 (350)	226	(740)	—	—	—	—	—	—	—	—	442	(1,450)	335	(1,100)
109,7 (360)	232	(760)	—	—	—	—	—	—	—	—	450	(1,475)	343	(1,125)
112,8 (370)	238	(780)	—	—	—	—	—	—	—	—	—	—	351	(1,150)
115,8 (380)	244	(800)	—	—	—	—	—	—	—	—	—	—	358	(1,175)
118,9 (390)	250	(820)	—	—	—	—	—	—	—	—	—	—	366	(1,200)
121,9 (400)	256	(840)	—	—	—	—	—	—	—	—	—	—	373	(1,225)

Note: Line lengths given in table will allow hook to touch ground. When block travel below ground is required, add additional rope equal to parts of line times added travel distance. Hoisting distance or line pull may be limited when block travel below ground is required. Maximum hook travel for luffing jib application may be restricted when wire rope length exceeds 411 m (1,350') using left rear drum without lagging or when wire rope length exceeds 381 m (1,250') using 622mm (24-1/2") diameter lagging on left rear drum.

Drums each provide 133 kN (30,000 lb) maximum single line pull.

Performance data

**Wire rope lengths -
Fixed jib No. 140 on
Luffing jib No. 133A or 133 on
Boom No. 44 with heavy-lift top**

Boom, luffing jib, and fixed jib length	Fixed jib whip line Left rear drum			
	(1 Part of line)		(2 Parts of line)	
	m	(ft)	m	(ft)
115,8 (380)	244	(800)	358	(1,175)
118,9 (390)	250	(820)	366	(1,200)
121,9 (400)	256	(840)	381	(1,250)
125,0 (410)	262	(860)	396	(1,300)
128,0 (420)	268	(880)	404	(1,325)
131,1 (430)	274	(900)	411	(1,350)
134,1 (440)	280	(920)	419	(1,375)
137,2 (450)	287	(940)	427	(1,400)
140,2 (460)	293	(960)	—	—
143,3 (470)	299	(980)	—	—
146,3 (480)	305	(1,000)	—	—
149,4 (490)	311	(1,020)	—	—
152,4 (500)	317	(1,040)	—	—
155,4 (510)	323	(1,060)	—	—
158,5 (520)	329	(1,080)	—	—

Note: Line lengths given in table will allow hook to touch ground. When block travel below ground is required, add additional rope equal to parts of line times added travel distance. Hoisting distance or line pull may be limited when block travel below ground is required.

Drums each provide 133 kN (30,000 lb) maximum single line pull.

Performance data

Wire rope lengths
Boom No. 44 with long-reach top
 - or -
Fixed jib No. 132 on
Boom No. 44 with long-reach top

Boom or boom and fixed jib length m (ft)	Whip line Left rear or front drum								Hoist line Right rear drum		Maximum required parts of line
	(1 Part of line)		(2 Parts of line)		(3 Parts of line)		(4 Parts of line)		m	(ft)	
	m	(ft)	m	(ft)	m	(ft)	m	(ft)			
57,9 (190)	131	(430)	191	(625)	—	—	—	—	488	(1,600)	7
61,0 (200)	137	(450)	198	(650)	—	—	—	—	511	(1,675)	7
64,0 (210)	143	(470)	206	(675)	—	—	—	—	533	(1,750)	7
67,1 (220)	149	(490)	221	(725)	—	—	—	—	564	(1,850)	7
70,1 (230)	155	(510)	229	(750)	297	(975)	373	(1,225)	587	(1,925)	7
73,2 (240)	162	(530)	236	(775)	312	(1,025)	389	(1,275)	625	(2,050)	7
76,2 (250)	168	(550)	244	(800)	320	(1,050)	404	(1,325)	625	(2,050)	6
79,2 (260)	174	(570)	251	(825)	335	(1,100)	—	—	625	(2,050)	6
82,3 (270)	180	(590)	259	(850)	343	(1,125)	—	—	625	(2,050)	6
85,3 (280)	186	(610)	274	(900)	358	(1,175)	—	—	625	(2,050)	5
88,4 (290)	192	(630)	282	(925)	373	(1,225)	—	—	625	(2,050)	5
91,4 (300)	198	(650)	290	(950)	381	(1,250)	—	—	625	(2,050)	4
94,5 (310)	201	(660)	297	(975)	396	(1,300)	—	—	625	(2,050)	4
97,5 (320)	207	(680)	303	(1,000)	404	(1,325)	—	—	625	(2,050)	4
100,6 (330)	213	(700)	312	(1,025)	—	—	—	—	625	(2,050)	4
103,6 (340)	219	(720)	328	(1,075)	—	—	—	—	—	—	—
106,7 (350)	226	(740)	335	(1,100)	—	—	—	—	—	—	—
109,7 (360)	232	(760)	343	(1,125)	—	—	—	—	—	—	—
112,8 (370)	238	(780)	351	(1,150)	—	—	—	—	—	—	—
115,8 (380)	244	(800)	358	(1,175)	—	—	—	—	—	—	—
118,9 (390)	250	(820)	366	(1,200)	—	—	—	—	—	—	—

Note: Line lengths given in table will allow hook to touch ground. When block travel below ground is required, add additional rope equal to parts of line times added travel distance. Hoisting distance or line pull may be limited when block travel below ground is required. Maximum hook travel for upper boom point application may be restricted when whip line length exceeds 387 m (1,270') using 622 mm (24-1/2") diameter lagging on left rear drum.

Drums each provide 133 kN (30,000 lb) maximum single line pull.

Performance data

Wire rope specifications 5:1 Safety factor
 Boom No. 44 with heavy-lift or long-reach top
 - or -
 Fixed jib No. 132 on
 Boom No. 44 with heavy-lift or long-reach top
 - or -
 Luffing jib No. 133A or 133 on
 Boom No. 44 with heavy-lift top
 - or -
 Fixed jib No. 140 on
 Luffing jib No. 133A or 133 on
 Boom No. 44 with heavy-lift top

	5:1 Safety factor Rotation resistant 1 960 N/mm ²	5:1 Safety factor Rotation resistant 1 770 N/mm ²	Only for helping reeve load lines: Regular lay 6 x 19 Filler wire IPS, IWRC
Function	Hoist or whip line	Hoist or whip line	Rigging winch line
Part number	No. 719375	No. 719374	No. 719019
Size wire rope	— (1-1/8")	29 mm —	— (3/8")
Minimum breaking strength	70 260 kg (154,900 lb)	70 170 kg (154,700 lb)	5 940 kg (13,100 lb)
Maximum load per line	13 610 kg (30,000 lb)	13 610 kg (30,000 lb)	— —
Approximate weight	4,02 kg/m (2.70 lb/ft)	4,25 kg/m (2.85 lb/ft)	— —

Drums and laggings - liftcrane

		Unequal split rear drums with front drum optional						
Application	Drum location	Drum part number	Drum type	Drum diameter	Drum width	Grooved lugging* (optional) part number	Wire rope size	
Basic liftcrane	Hoist	Right rear	171304	Bare	572 mm (22-1/2")	1141 mm (44-29/32")	502411 with Spacer 197045 502402	29 mm (1-1/8")
	Whip	Left rear	171305	Bare	572 mm (22-1/2")	480 mm (18-29/32")	502412 with Spacer 197044 502401 with Spacer 192568 Pending	29 mm (1-1/8")
	Whip (optional)	Front	171304 with Spacer 176959	Bare	572 mm (22-1/2")	961 mm (37-53/64")	Pending	29 mm (1-1/8")

Note: Grooved laggings for 29 mm or (1-1/8") wire rope are optional for liftcrane application.

*622 mm (24-1/2") diameter.

Performance data

Drums and laggings - liftcrane								
Application	Tandem drums - 1 854 mm (73") wide (optional)							
	Drum location	Drum part number	Drum type	Drum diameter	Drum width	Grooved lagging* (optional) part number	Wire rope size	
Basic liftcrane	Hoist	Rear	173521 with Spacer 176961	Bare	572 mm (22-1/2")	1 141 mm (44-29/32")	Pending 502402	29 mm (1-1/8")
	Whip	Front	173520 with Spacer 175153 or 176960	Bare	572 mm (22-1/2")	961 mm (37-53/64")	Pending Pending	29 mm (1-1/8")

Note: Grooved laggings for 29 mm or (1-1/8") wire rope are optional for liftcrane application.
*622 mm (24-1/2") diameter.

Drums and laggings - Container handling / clamshell								
Application	Equal split rear drums with front drum optional							
	Drum location	Drum part number	Lagging type	Lagging diameter	Lagging width	Lagging part number	Wire rope size	
Container handling	Hoist	Right rear	172919	Grooved	622 mm (24-1/2")	810 mm (31-29/32")	Pending 502364	29 mm (1-1/8")
	Hoist	Left rear	172920	Grooved	622 mm (24-1/2")	810 mm (31-29/32")	Pending 502364	29 mm (1-1/8")
	Auxiliary (optional)	Front	171304 with Spacer 176959	Bare	—	—	—	29 mm (1-1/8")
Clamshell	Closing	Right rear	172919	Grooved	622 mm (24-1/2")	810 mm (31-29/32")	Pending 502365	29 mm (1-1/8")
	Holding	Left rear	172920	Grooved	622 mm (24-1/2")	810 mm (31-29/32")	Pending 502365	29 mm (1-1/8")

Performance data

Drum capacities, standard drums - wire rope		
	Maximum length	
	No lagging	With lagging**
Right rear drum (hoist) 29 mm Wire Rope*	730 m 8 Layers	776 m 8 Layers
(1-1/8") Wire rope*	(2,411 ft) 8 Layers	(2,566 ft) 8 Layers
Left rear drum (whip) 29 mm wire rope*	355 m 9 Layers	323 m 8 Layers
(1-1/8") Wire rope*	(1,173 ft) 9 Layers	(1,068 ft) 8 Layers
Front drum (ship) 29 mm wire rope*	614 m 8 Layers	653 m 8 Layers
(1-1/8") Wire rope*	(2,028 ft) 8 Layers	(2,158 ft) 8 Layers

*6 m (20') is deducted from maximum spooling capacities for 3 dead wraps per drum or lagging.

**Lagging diameter 622 mm (24-1/2").

Drums - 133,4 kN (30,000 lb)								
Line pull kN (lb)	Single line pull/single line speed*							
	m/min (ft/min)							
Layer	1	2	3	4	5	6	7	8
0 (0)	102 (335)	111 (365)	120 (394)	129 (424)	138 (453)	147 (483)	156 (512)	165 (542)
22,2 (5,000)	102 (335)	111 (365)	120 (394)	129 (424)	138 (453)	147 (481)	155 (509)	164 (537)
44,5 (10,000)	100 (328)	108 (355)	116 (381)	124 (408)	132 (433)	140 (459)	148 (484)	155 (509)
66,7 (15,000)	97 (317)	104 (342)	112 (366)	119 (390)	126 (413)	133 (436)	140 (458)	146 (480)
89,0 (20,000)	94 (307)	100 (329)	107 (351)	113 (370)	115 (378)	118 (386)	120 (394)	123 (402)
111,2 (25,000)	90 (295)	92 (303)	95 (311)	97 (319)	100 (327)	102 (336)	105 (344)	107 (352)
133,4 (30,000)	80 (261)	82 (269)	84 (277)	87 (286)	90 (294)	92 (302)	95 (310)	97 (318)

NOTE: Line pull is infinitely variable.

*Based on lagging diameter of 622 mm (24-1/2").

Working weight			
Configuration	kg (lb)		
	Series 1	Series 2	Series 3
21,3 m (70') No. 44 Boom	203 069 (447,690)	248 485 (547,815)	293 844 (647,815)
76,2 m (250') No. 44 Main boom with 36,6 m (120') No. 132 Fixed jib	219 804* (484,585)*	265 776 (585,935)	311 135 (685,935)
61,0 m (200') No. 44 Main boom with 61,0 m (200') No. 133A Luffing jib	231 373** (510,090)**	277 803 (612,450)	323 162 (712,450)

Typical working weight includes: optional self-assembly carbody jacks, hydraulic reservoirs full, fuel half-full, drums loaded with standard lengths of wire rope, upper boom point, 272 mt (300 t) hook block, and 13,6 mt (15 t) weight ball.

Note: Upper boom point not used with fixed jib or luffing jib.

*70,1 m (230') No. 44 main boom and 36,6 m (120') fixed jib maximum allowed for Series 1.

**57,9 m (190') No. 44 main boom and 61,0 m (200') luffing jib maximum allowed for Series 1.

Performance data

Maximum length — unassisted raising

Method	Fixed jib No. 132 on Boom No. 44 with heavy-lift top Series 3	
	Main boom	Fixed jib
Over end of blocked crawlers m (ft)	91,4 (300)	— —
	88,4 (290)	— —
	85,3 (280)	— —
	82,3 (270)	— —
	79,2 (260)	24,4 (80)
	76,2 (250)	36,6 (120)

NOTE: Load block(s), hook(s) and weight ball(s) on ground at start. Upper boom point cannot be used when jib is attached.

Boom lengths of 76,2 m (250') through 91,4 m (300') require only three middle sheaves in lower boom point, all others must be removed from lower boom point.

Maximum length — unassisted raising

Method	Fixed jib No. 132 on Boom No. 44 with long-reach top Series 3	
	Main boom	Fixed jib
Over end of blocked crawlers m (ft)	100,6 (330)	— —
	97,5 (320)	— —
	94,5 (310)	— —
	91,4 (300)	— —
	88,4 (290)	— —
	85,3 (280)	18,3 (60)
	82,3 (270)	36,6 (120)

NOTE: Load block(s), hook(s) and weight ball(s) on ground at start. Upper boom point cannot be used when jib is attached.

Maximum length — unassisted raising

Method	Luffing jib No. 133A or 133 on Boom No. 44 with heavy-lift top Series 3			
	In-line procedure		Layout Jack-knife procedure	
	Main boom	Luffing jib	Main boom	Luffing jib
Over end of blocked crawlers m (ft)	24,4 (80)	21,3 - 61,0 (70 - 200)	33,5 (110)	61,0 (200)
	27,4 (90)	21,3 - 61,0 (70 - 200)	36,6 (120)	57,9 - 61,0 (190 - 200)
	30,5 (100)	21,3 - 61,0 (70 - 200)	39,6 (130)	51,8 - 61,0 (170 - 200)
	33,5 (110)	21,3 - 57,9 (70 - 190)	42,7 (140)	48,8 - 61,0 (160 - 200)
	36,6 (120)	21,3 - 54,9 (70 - 180)	45,7 (150)	42,7 - 61,0 (140 - 200)
	39,6 (130)	21,3 - 48,8 (70 - 160)	48,8 (160)	36,6 - 61,0 (120 - 200)
	42,7 (140)	21,3 - 45,7 (70 - 150)	51,8 (170)	30,5 - 61,0 (100 - 200)
	45,7 (150)	21,3 - 39,6 (70 - 130)	54,9 (180)	24,4 - 61,0 (80 - 200)
	48,8 (160)	21,3 - 33,5 (70 - 110)	57,9 (190)	21,3 - 61,0 (70 - 200)
	51,8 (170)	21,3 - 27,4 (70 - 90)	61,0* (200)*	21,3 - 61,0 (70 - 200)
	54,9 (180)	21,3 (70)	64,0* (210)*	33,5 - 45,7 (110 - 150)

NOTE: Load block(s), hook(s) and weight ball(s) on ground until boom and luffing jib are erected.

*Requires only middle three sheaves to be used in lower boom point, all others must be removed from lower boom point.

Combinations of boom and luffing jib to 76,2 m (250') and 61,0 m (200') can be raised over front of blocked crawlers with outside assist.

Maximum length — unassisted raising

Method	Fixed jib No. 140 set at 5° angle on Luffing jib No. 133 or 133A on Boom No. 44 with heavy-lift top Series 3 Layout jack-knife procedure		
	Main boom	Luffing jib	Fixed jib
Over end of blocked crawlers m (ft)	54,9 (180)	48,8 - 61,0 (160 - 200)	12,2 - 36,6 (40 - 120)
	57,9 (190)	48,8 - 61,0 (160 - 200)	12,2 - 36,6 (40 - 120)
	61,0* (200)*	48,8 - 61,0 (160 - 200)	12,2 - 36,6 (40 - 120)

NOTE: Load block(s), hook(s) and weight ball(s) on ground until boom and luffing jib are erected.

*Requires only middle three sheaves to be used in lower boom point, all others must be removed from lower boom point.

Boom combinations

No. 44 Main boom with heavy-lift top combinations				
Boom length m (ft)	Boom inserts			
	3,0 m (10 ft)	6,1 m (20 ft)	12,2 m (40 ft)	12,2 m* (40 ft)*
24,4 (80)	1	—	—	—
27,4 (90)	—	1	—	—
30,5 (100)	1	1	—	—
33,5 (110)	—	—	1	—
36,6 (120)	1	—	1	—
39,6 (130)	—	1	1	—
42,7 (140)	1	1	1	—
45,7 (150)	—	—	2	—
48,8 (160)	1	—	2	—
51,8 (170)	—	1	2	—
54,9 (180)	1	1	2	—
57,9 (190)	—	—	3	—
61,0 (200)	1	—	3	—
64,0 (210)	—	1	3	—
67,1 (220)	1	1	3	—
70,1 (230)	—	—	4	—
73,2 (240)	1	—	4	—
76,2 (250)	—	1	4	—
79,2 (260)	1	1	4	—
82,3 (270)	—	—	5	—
85,3 (280)	1	—	4	1
88,3 (290)	—	1	4	1
91,4 (300)	1	1	4	1

*Light weight inserts.
Note: Intermediate suspension required for 85,3 m (280') and longer boom lengths.

No. 132 Fixed jib combinations	
Jib length m (ft)	Fixed jib inserts
12,2 (40)	—
18,3 (60)	1
24,4 (80)	2
30,5 (100)	3
36,6 (120)	4

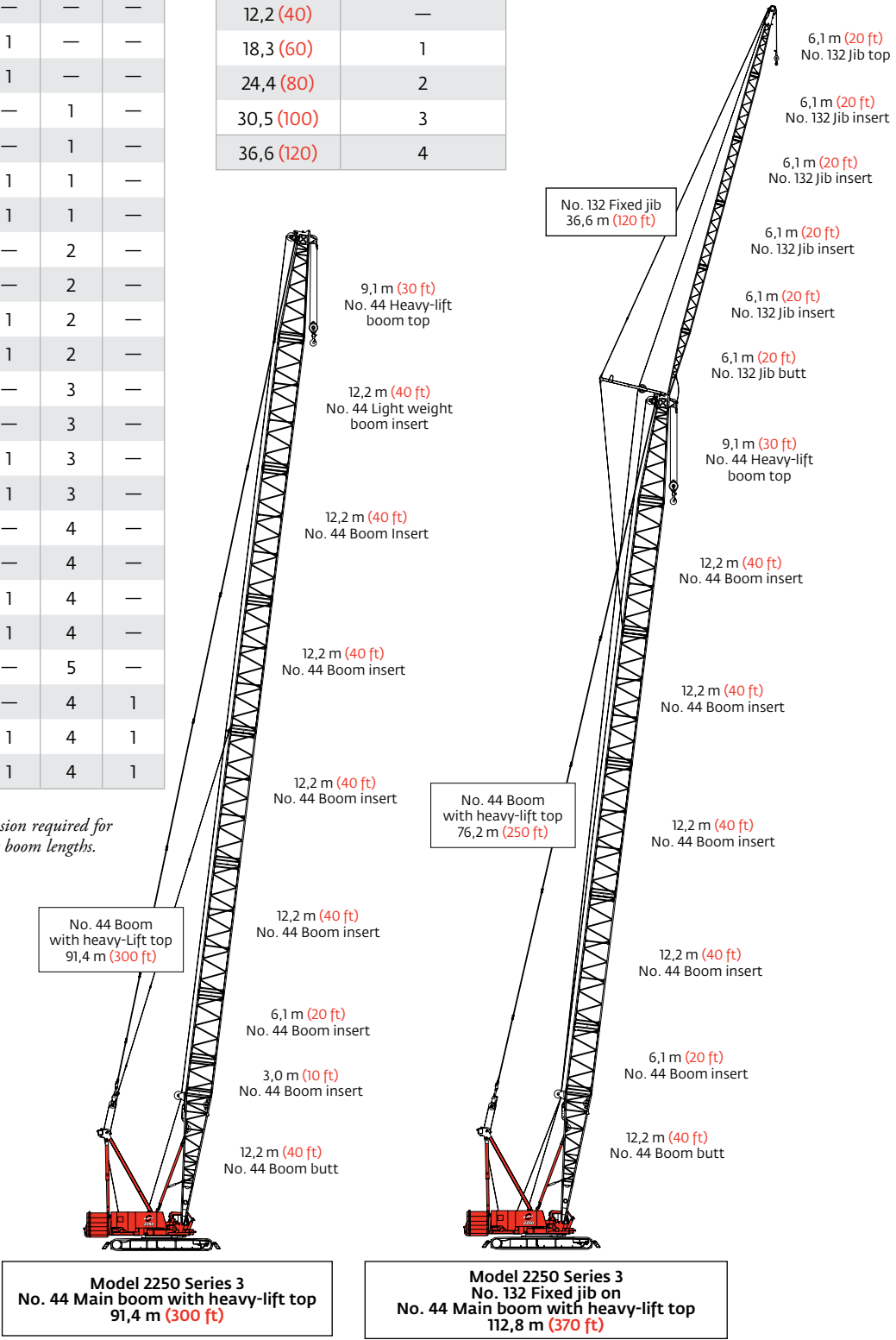

Model 2250 Series 3
No. 44 Main boom with heavy-lift top
91,4 m (300 ft)

Model 2250 Series 3
No. 132 Fixed jib on
No. 44 Main boom with heavy-lift top
112,8 m (370 ft)

Boom combinations

No. 44 Long-reach main boom combinations

Boom length m (ft)	Boom inserts			
	3,0 m (10 ft)	6,1 m (20 ft)	12,2 m (40 ft)	12,2 m* (40 ft)*
57,9 (190)	—	—	2	—
61,0 (200)	1	—	2	—
64,0 (210)	—	1	2	—
67,1 (220)	1	1	2	—
70,1 (230)	—	—	3	—
73,2 (240)	1	—	3	—
76,2 (250)	—	1	3	—
79,2 (260)	1	1	3	—
82,3 (270)	—	—	4	—
85,3 (280)	1	—	4	—
88,4 (290)	—	1	4	—
91,4 (300)	1	1	3	1
94,4 (310)	—	—	4	1
97,5 (320)	1	—	4	1
100,6 (330)	—	1	4	1

No. 132 Fixed jib combinations

Jib length m (ft)	Fixed jib inserts
	6,1 m (20 ft)
12,2 (40)	—
18,3 (60)	1
24,4 (80)	2
30,5 (100)	3
36,6 (120)	4

*Light weight inserts.

Note: Intermediate suspension required for 91,4 m (300') and longer boom lengths.

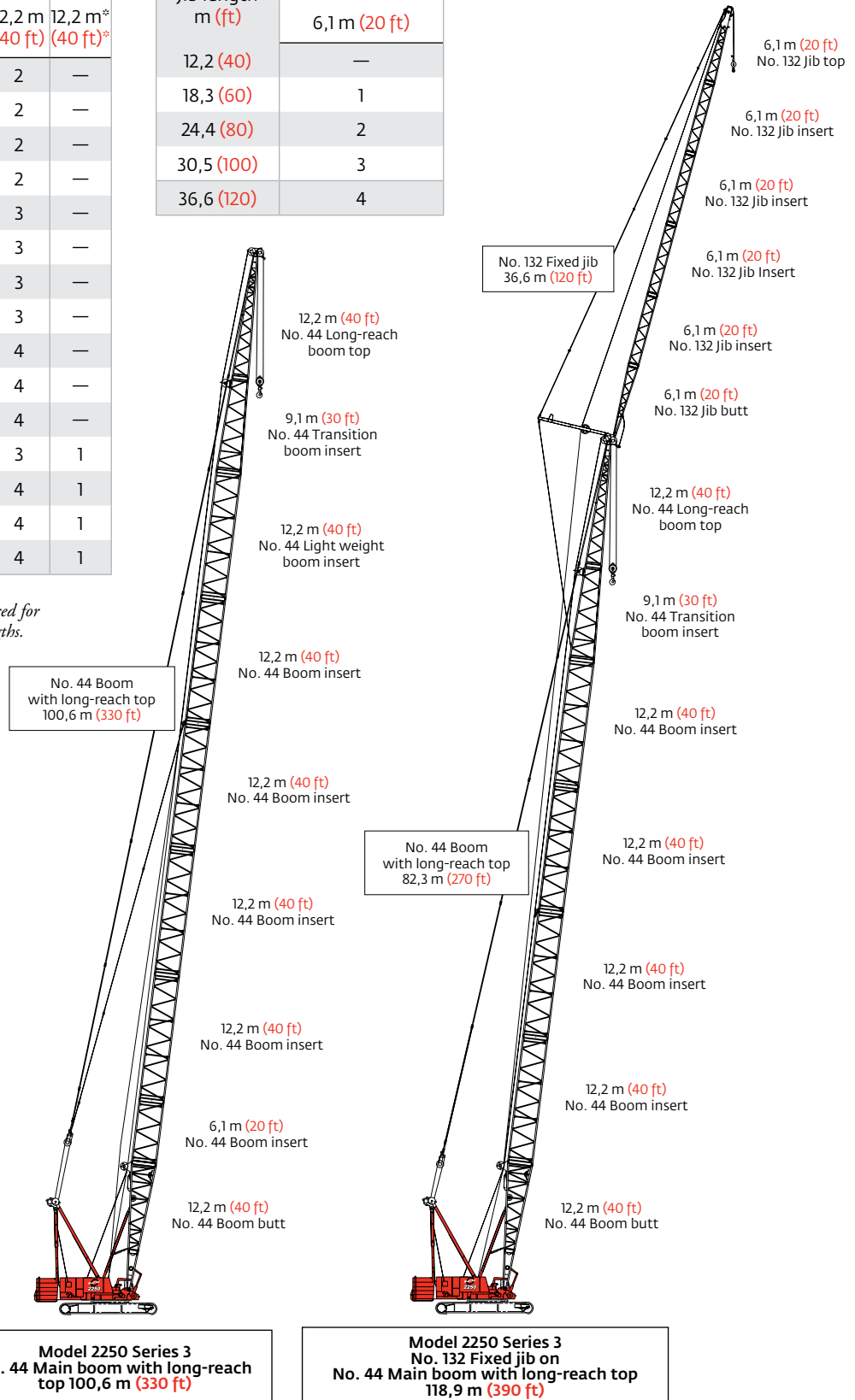

Boom combinations

No. 133A or 133 Luffing jib combinations

Luffing jib length m (ft)	Luffing jib inserts		
	3,0 m (10 ft)	6,1 m (20 ft)	12,2 m (40 ft)
21,3 (70)	—	—	—
24,4 (80)	1	—	—
27,4 (90)	—	1	—
30,5 (100)	1	1	—
33,5 (110)	—	—	1
36,6 (120)	1	—	1
39,6 (130)	—	1	1
42,7 (140)	1	1	1
45,7 (150)	—	—	2
48,8 (160)	1	—	2
51,8 (170)	—	1	2
54,9 (180)	1	1	2
57,9 (190)	—	—	3
61,0 (200)	1	—	3

No. 140 Fixed jib combinations

Jib length m (ft)	Fixed jib inserts
	6,1 m (20 ft)
12,2 (40)	—
18,3 (60)	1
24,4 (80)	2
30,5 (100)	3
36,6 (120)	4

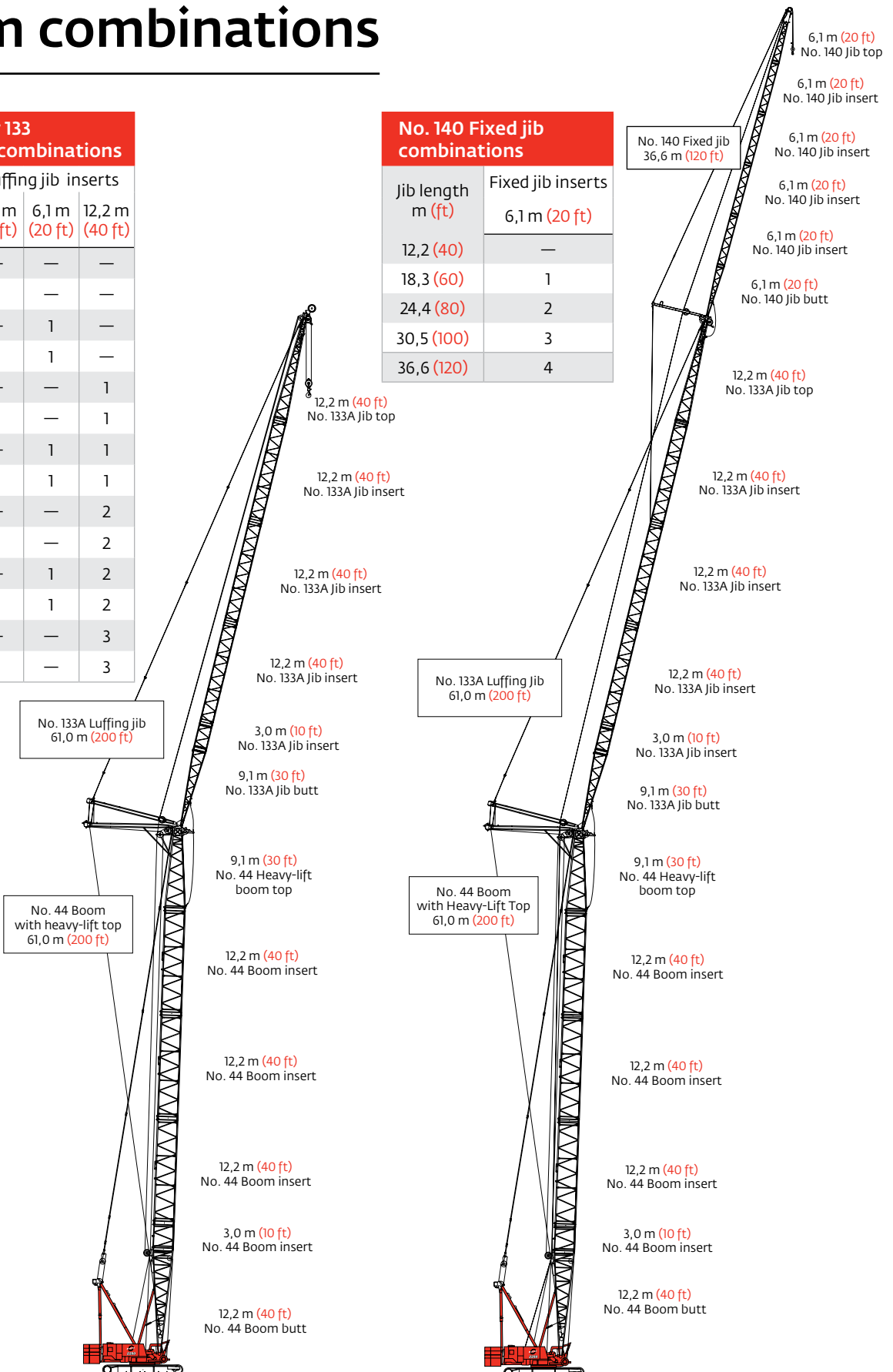

Model 2250 Series 3
 No. 133A or No. 133 Luffing jib on
 No. 44 Main boom with heavy-lift top
 121,9 m (400 ft)

Model 2250 Series 3
 No. 140 Fixed jib on No. 133A or No. 133 Luffing jib on
 No. 44 Main boom with heavy-lift top
 158,5 m (520 ft)

Heavy-lift boom range diagram

No. 44 Heavy-lift boom

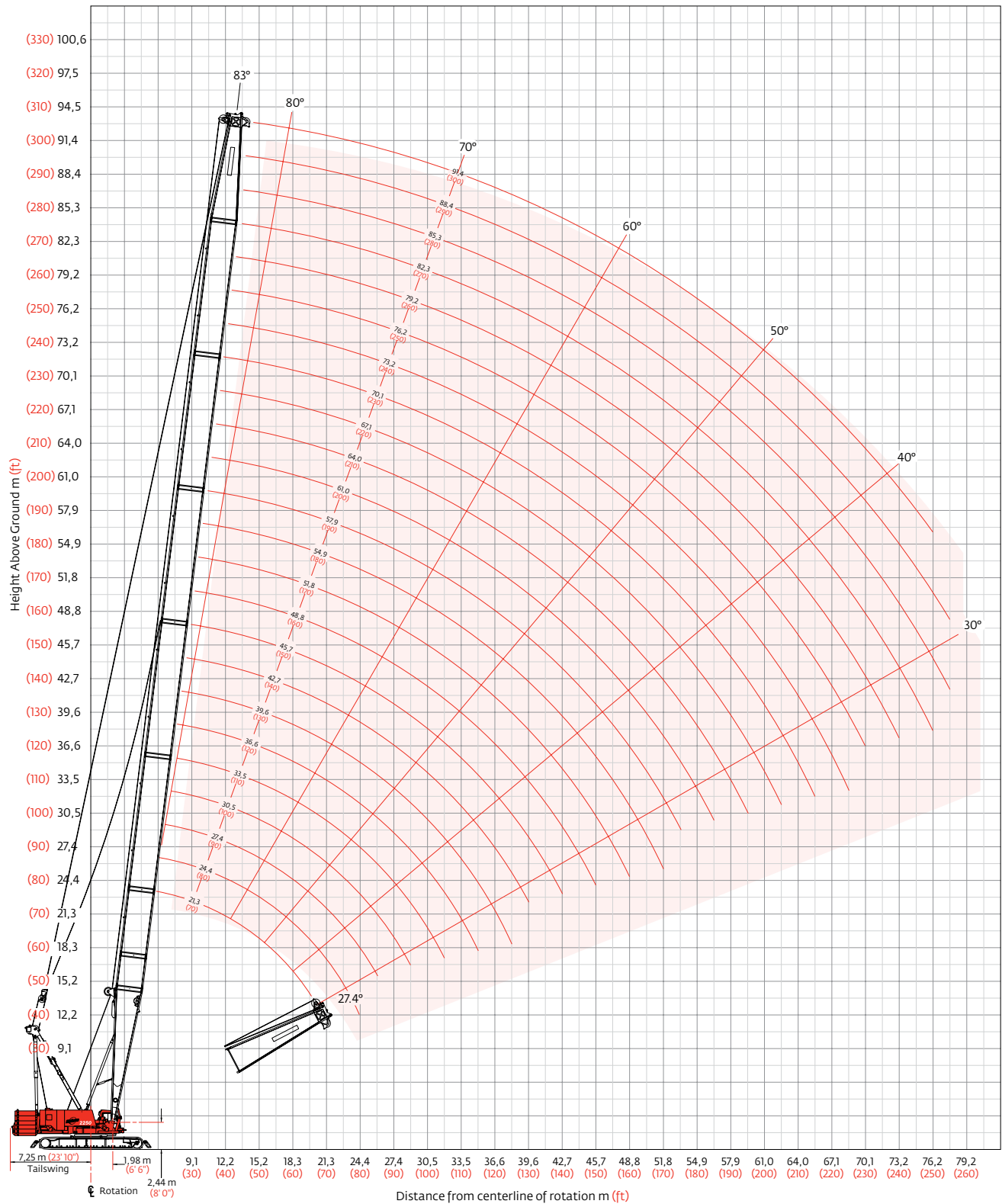

Heavy-lift boom load charts

Liftcrane boom capacities - 2250 Series 3 Boom No. 44 with heavy lift top

Boom m (ft) Radius	113 040 kg (249,200 lb) Crane counterweight 54 430 kg (120,000 lb) Carbody counterweight 360° Rating kg (lb) x1 000											
	21,3 (70)	27,4 (90)	33,5 (110)	39,6 (130)	45,7 (150)	51,8 (170)	57,9 (190)	67,1 (220)	73,2 (240)	79,2 (260)	85,3 (280)	91,4 (300)
5,5 (18)	272,1 (600.0)											
7,0 (22)	239,3 (541.5)	223,4 (495.6)	169,8 —									
8,0 (26)	210,8 (469.1)	210,4 (468.1)	166,2 (367.0)	158,8 (350.7)								
9,0 (30)	188,2 (408.7)	187,8 (407.7)	162,9 (358.2)	155,9 (343.0)	135,8 (298.6)	— (284.1)						
11,0 (36)	154,1 (340.9)	154,2 (340.9)	153,8 (339.8)	150,9 (333.2)	130,7 (288.3)	124,9 (275.6)	108,2 (238.8)					
12,0 (40)	135,9 (293.0)	140,7 (304.2)	140,4 (303.9)	138,0 (298.3)	128,4 (282.3)	123,1 (270.7)	106,5 (234.2)	97,7 (214.8)	— (185.8)			
14,0 (46)	109,0 (239.8)	113,0 (248.7)	112,8 (248.3)	112,6 (247.9)	110,9 (244.2)	107,4 (236.4)	103,1 (227.2)	90,8 (200.2)	80,9 (178.4)	73,8 (162.8)	64,4 (142.0)	55,9 (123.3)
15,0 (50)	98,6 (212.6)	102,5 (221.2)	102,3 (220.8)	102,2 (220.4)	101,9 (219.6)	99,1 (214.7)	96,1 (207.8)	87,5 (191.2)	78,3 (171.3)	71,5 (156.5)	63,4 (138.6)	55,6 (122.6)
18,0 (60)	74,7 (160.4)	79,8 (172.4)	79,5 (171.8)	79,4 (171.4)	78,9 (170.5)	78,8 (169.8)	77,7 (168.3)	74,4 (160.5)	70,5 (153.9)	64,4 (140.7)	58,5 (129.1)	53,0 (116.0)
22,0 (70)	— (110.2)	59,4 (137.4)	60,7 (139.5)	60,4 (139.0)	60,0 (138.1)	59,7 (137.4)	59,2 (136.4)	58,4 (133.8)	56,5 (129.5)	55,4 (125.9)	55,0 (125.0)	48,4 (108.3)
24,0 (80)		51,6 (110.7)	54,0 (116.6)	53,8 (116.1)	53,3 (115.1)	53,0 (114.5)	52,5 (113.4)	51,9 (112.0)	50,9 (110.2)	50,1 (108.3)	48,9 (105.8)	46,4 (101.7)
28,0 (90)			42,8 (97.6)	43,6 (99.0)	43,2 (98.0)	42,8 (97.3)	42,3 (96.2)	41,7 (94.8)	41,2 (93.7)	41,3 (93.6)	40,2 (91.1)	38,8 (88.0)
30,0 (100)			37,8 (80.9)	39,6 (85.6)	39,2 (84.7)	38,9 (84.0)	38,4 (82.9)	37,8 (81.5)	37,2 (80.3)	37,3 (80.5)	36,7 (79.5)	35,4 (76.6)
34,0 (110)				32,1 (72.7)	32,9 (74.1)	32,6 (73.4)	32,1 (72.3)	31,4 (70.8)	30,9 (69.6)	30,9 (69.8)	30,7 (69.2)	29,8 (67.2)
36,0 (120)				28,7 (61.1)	29,9 (64.1)	30,0 (64.7)	29,5 (63.6)	28,8 (62.1)	28,3 (60.9)	28,4 (61.1)	28,1 (60.5)	27,5 (59.4)
42,0 (140)					21,9 (46.3)	22,9 (49.1)	23,2 (49.5)	22,6 (48.8)	22,1 (47.6)	22,2 (47.8)	21,9 (47.1)	21,3 (45.4)
50,0 (160)						— (35.5)	15,8 (37.1)	16,0 (37.4)	15,8 (37.0)	16,3 (38.0)	15,2 (35.8)	13,9 (32.8)
56,0 (180)								11,8 (27.8)	11,7 (27.4)	12,2 (28.6)	11,2 (26.4)	9,8 (23.3)
62,0 (200)								8,5 (20.0)	8,4 (19.7)	8,9 (21.0)	8,1 (19.0)	6,8 (16.1)
68,0 (220)									5,6 (13.3)	6,2 (14.7)	5,5 (13.0)	4,3 (10.4)
72,0 (235)										4,7 (10.8)	4,0 (9.2)	3,0 (7.0)
74,0 (245)											3,3 (6.9)	2,4 (5.0)
76,0 (255)											2,6 (4.7)	1,9 —

Fixed jib No. 132 on Boom No. 44

Jib length m (ft)	Deduct from capacity when fixed jib is attached kg (lb)
12,2 (40)	2 900 (6,400)
18,3 (60)	3 720 (8,200)
24,4 (80)	4 670 (10,300)
30,5 (100)	5 810 (12,800)
36,6 (120)	6 940 (15,300)

Meets ANSI B30.5 Requirements - Capacities do not exceed 75% of static tipping load.

NOTICE: This capacity chart is for reference only and must not be used for lifting purposes.

Long-reach boom range diagram

No. 44 Long-reach boom

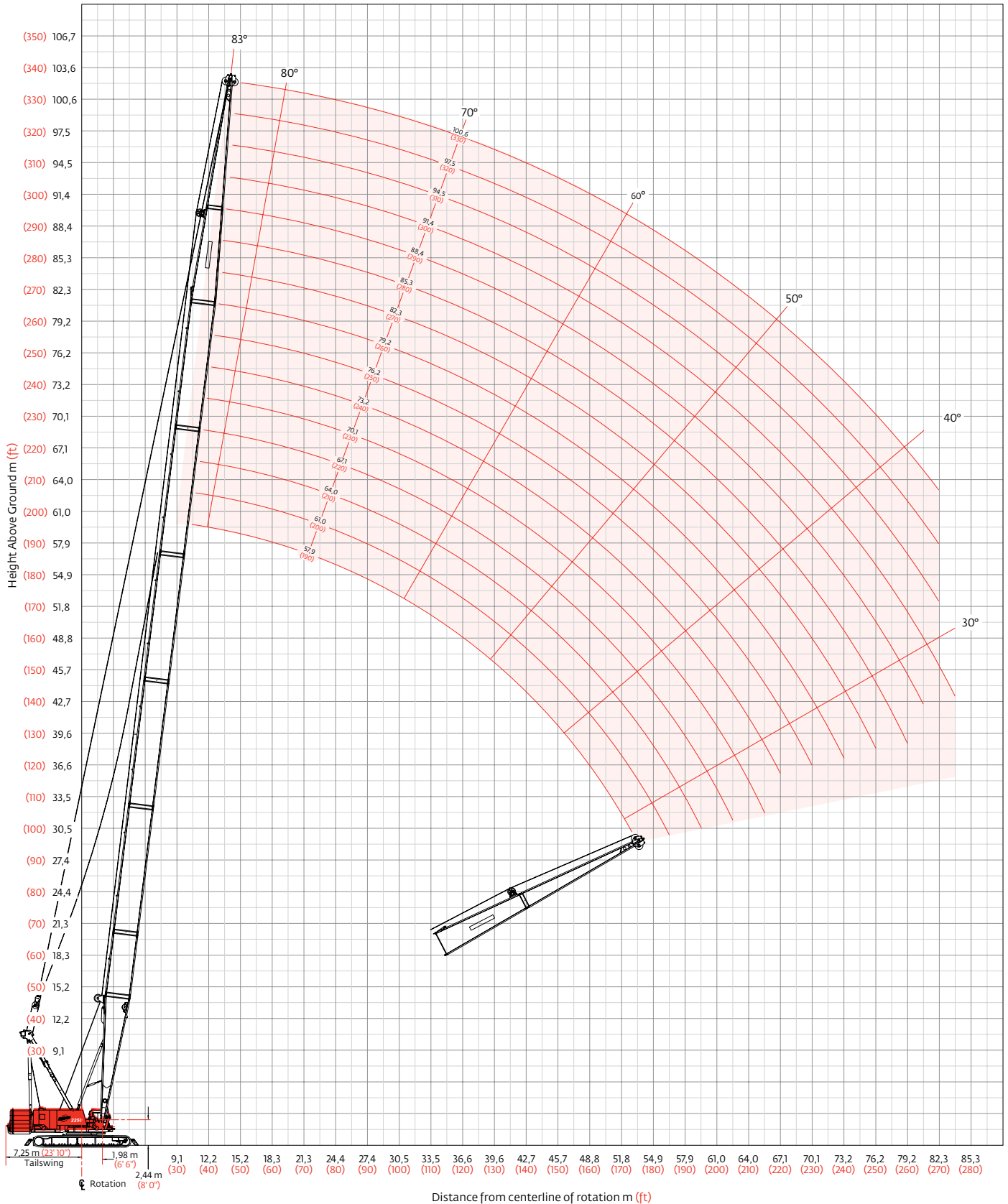

Long-reach top load chart

Liftcrane boom capacities - 2250 Series 3 Boom No. 44 with long reach top												
Boom m (ft) Radius	113 040 kg (249,200 lb) Crane counterweight 54 430 kg (120,000 lb) Carbody counterweight 360° Rating kg (lb) x 1 000											
	57,9 (190)	61,0 (200)	64,0 (210)	70,1 (230)	73,2 (240)	76,2 (250)	82,3 (270)	85,3 (280)	88,4 (290)	94,5 (310)	97,5 (320)	100,6 (330)
9,8 (32)	95,2 (210.0)	95,2 (210.0)										
11,0 (36)	95,2 (210.0)	95,2 (210.0)	95,2 (210.0)	89,0 (196.3)								
12,0 (40)	95,2 (210.0)	95,2 (210.0)	95,2 (210.0)	87,5 (192.4)	84,7 (186.3)	— (178.8)						
14,0 (46)	95,2 (210.0)	95,2 (210.0)	95,2 (210.0)	84,8 (187.0)	82,3 (181.4)	79,0 (174.3)	69,3 (152.9)	64,2 (141.6)	59,8 (131.9)	48,9 (108.0)		
15,0 (50)	95,2 (210.0)	95,2 (210.0)	94,0 (205.7)	83,6 (183.8)	81,1 (178.0)	77,7 (170.1)	68,5 (150.6)	63,7 (140.2)	59,3 (130.6)	48,3 (105.9)	44,7 (98.1)	41,2 (90.2)
18,0 (60)	80,6 (173.2)	80,1 (172.9)	79,5 (171.9)	76,8 (166.3)	74,8 (163.6)	71,5 (156.4)	63,5 (139.0)	60,3 (131.7)	57,1 (125.0)	44,6 (97.8)	41,4 (90.5)	37,6 (82.4)
22,0 (70)	61,3 (140.9)	61,0 (140.3)	60,9 (140.1)	60,5 (139.0)	59,9 (137.0)	59,3 (135.7)	56,6 (127.6)	53,6 (120.7)	50,9 (114.5)	40,7 (91.2)	37,3 (83.6)	33,9 (76.1)
24,0 (80)	54,6 (118.0)	54,3 (117.4)	54,2 (117.1)	53,7 (116.1)	53,5 (115.5)	53,3 (115.1)	51,9 (112.1)	50,5 (110.2)	47,9 (104.5)	39,1 (85.6)	35,6 (77.9)	32,3 (70.8)
30,0 (100)	40,6 (87.6)	40,3 (87.0)	40,2 (86.8)	39,7 (85.7)	39,4 (85.0)	39,2 (84.7)	38,7 (83.5)	38,4 (82.9)	38,2 (82.5)	34,9 (76.5)	31,4 (68.6)	28,4 (62.2)
36,0 (120)	31,7 (68.4)	31,4 (67.8)	31,3 (67.6)	30,7 (66.4)	30,5 (65.8)	30,3 (65.5)	29,8 (64.3)	29,5 (63.6)	29,3 (63.3)	28,3 (61.2)	27,7 (59.9)	25,4 (55.5)
40,0 (130)	27,4 (61.3)	27,1 (60.6)	27,0 (60.4)	26,4 (59.2)	26,2 (58.6)	26,0 (58.3)	25,5 (57.1)	25,2 (56.4)	25,0 (56.0)	24,5 (54.8)	23,9 (53.5)	23,4 (52.1)
42,0 (140)	25,6 (55.2)	25,3 (54.6)	25,1 (54.3)	24,6 (53.2)	24,3 (52.5)	24,2 (52.2)	23,6 (51.0)	23,4 (50.3)	23,2 (49.9)	22,7 (48.9)	22,3 (48.0)	22,2 (48.1)
50,0 (160)	18,8 (43.7)	18,8 (43.7)	19,0 (44.2)	18,9 (43.4)	18,6 (42.8)	18,5 (42.5)	17,9 (41.2)	17,6 (40.6)	17,4 (40.2)	16,6 (38.8)	16,1 (37.8)	16,4 (38.4)
52,0 (170)	17,3 (38.6)	17,3 (38.6)	17,6 (39.1)	17,4 (38.8)	17,3 (38.5)	17,3 (38.5)	16,8 (37.3)	16,4 (36.6)	16,3 (36.3)	15,1 (33.7)	14,7 (32.7)	15,0 (33.4)
56,0 (185)		14,6 (31.8)	14,9 (32.5)	14,8 (32.3)	14,7 (32.0)	14,8 (32.1)	14,4 (31.4)	14,3 (31.0)	14,2 (30.8)	12,6 (27.3)	12,1 (26.3)	12,4 (26.9)
60,0 (195)			— (28.4)	12,6 (28.5)	12,4 (28.2)	12,5 (28.3)	12,2 (27.6)	12,0 (27.2)	11,9 (27.0)	10,4 (23.6)	9,9 (22.6)	10,2 (23.2)
62,0 (205)				11,5 (25.0)	11,4 (24.7)	11,5 (24.9)	11,1 (24.2)	10,9 (23.7)	10,9 (23.6)	9,4 (20.3)	8,9 (19.3)	9,2 (19.9)
66,0 (215)				— (21.4)	9,5 (21.6)	9,6 (21.8)	9,3 (21.1)	9,1 (20.6)	9,0 (20.5)	7,6 (17.3)	7,1 (16.3)	7,4 (16.9)
72,0 (240)							6,9 (14.4)	6,7 (14.0)	6,6 (13.7)	5,3 (10.9)	4,9 (10.0)	5,2 (10.6)
76,0 (250)							5,5 (12.0)	5,2 (11.4)	4,9 (10.7)	4,0 (8.7)	3,6 (7.8)	3,8 (8.4)
78,0 (265)								4,3 (—)	4,0 (6.3)	3,3 (5.7)	3,0 (4.9)	3,2 (5.5)
80,0 (270)									3,2 (—)	2,7 (4.7)	2,4 (4.0)	2,7 (4.6)
82,0 (275)										2,2 (—)	1,8 (—)	2,1 (—)

Fixed jib No. 132 on Boom No. 44	
Jib length m (ft)	Deduct from capacity when fixed jib is attached kg (lb)
12,2 (40)	2 900 (6,400)
18,3 (60)	3 720 (8,200)
24,4 (80)	4 670 (10,300)
30,5 (100)	5 810 (12,800)
36,6 (120)	6 940 (15,300)

Meets ANSI B30.5 Requirements - Capacities do not exceed 75% of static tipping load.

NOTICE: This capacity chart is for reference only and must not be used for lifting purposes.

Fixed jib range diagram

No. 132 Fixed jib on No. 44 Heavy-lift boom

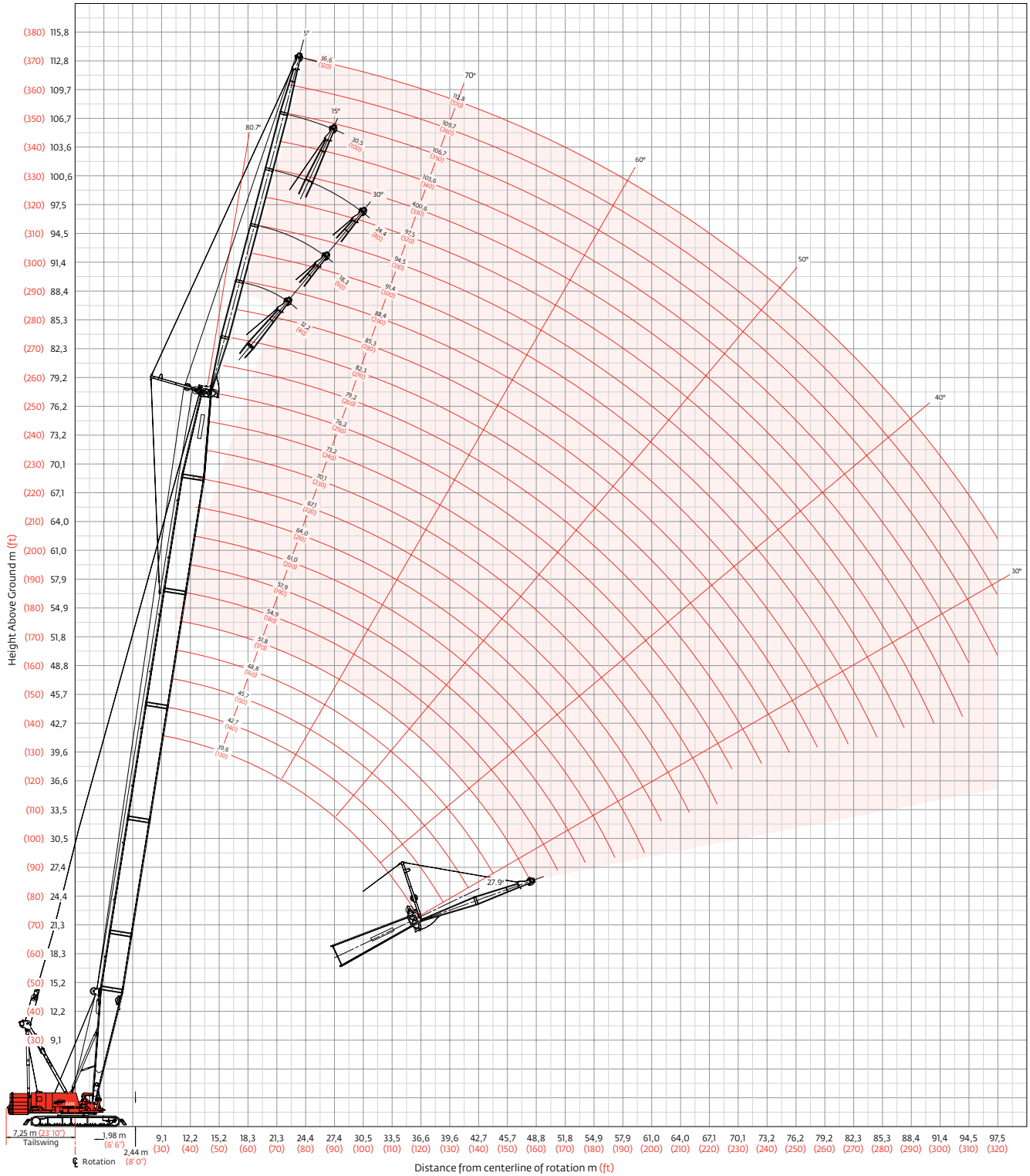

Fixed jib load charts

Liftcrane jib capacities - 2250 Series 3

Jib No. 132 with 6 096 mm (20 ft) strut on Boom No. 44 with heavy-lift top

113 040 kg (249,200 lb) Crane counterweight 54 430 kg (120,000 lb) Carbody counterweight
360° Rating kg (lb) x 1 000

Boom m (ft) Radius	5° Offset					30° Offset				
	39,6 (130)	48,8 (160)	57,9 (190)	70,1 (230)	79,2 (260)	39,6 (130)	48,8 (160)	57,9 (190)	70,1 (230)	79,2 (260)
12,2 (40)	45,3 (100.0)									
14,0 (45)	42,3 (94.2)	44,5 (99.0)								
18,0 (60)	37,6 (82.3)	40,0 (87.6)	41,9 (92.0)	40,8 (90.0)	— (90.0)	25,3 (55.5)	— (57.4)			
24,0 (80)	32,4 (71.0)	34,8 (76.2)	36,9 (80.8)	39,3 (86.1)	40,6 (89.5)	22,3 (48.8)	23,4 (51.3)	24,3 (53.3)	25,3 (55.5)	
30,0 (110)	28,7 (59.6)	31,0 (64.5)	33,1 (68.9)	35,5 (71.4)	36,9 (70.6)	20,0 (41.9)	21,2 (44.5)	22,2 (46.2)	23,3 (49.2)	25,8 (56.8)
40,0 (140)	24,5 (52.4)	26,4 (53.2)	25,8 (51.5)	24,7 (49.2)	24,3 (48.4)	17,5 (37.7)	18,6 (39.9)	19,6 (42.1)	20,7 (44.6)	24,0 (50.8)
52,0 (170)		16,5 (36.7)	16,4 (36.6)	15,8 (35.3)	15,5 (34.5)			17,4 (38.7)	16,5 (36.7)	21,5 (46.3)
60,0 (200)			11,5 (24.3)	10,9 (23.2)	11,0 (23.2)				11,9 (25.2)	16,2 (36.1)
68,0 (230)				7,2 (14.1)	7,2 (14.2)					12,1 (25.5)
76,0 (250)				4,1 (9.1)	4,2 (9.3)					8,0 (15.7)
80,0 (270)					3,0 (5.2)					

Boom m (ft) Radius	5° Offset					30° Offset				
	39,6 (130)	48,8 (160)	57,9 (190)	70,1 (230)	79,2 (260)	39,6 (130)	48,8 (160)	57,9 (190)	70,1 (230)	79,2 (260)
15,2 (50)	32,8 (72.4)									
16,0 (55)	32,5 (70.9)	— (72.5)								
20,0 (70)	30,8 (66.8)	31,6 (68.7)	32,3 (70.3)	33,0 (71.9)	— (60.0)	— (41.8)				
28,0 (90)	28,0 (62.2)	29,0 (64.4)	29,8 (66.2)	30,7 (68.2)	27,2 (60.0)	16,5 (36.8)	17,2 (38.5)	17,9 (39.9)	18,6 (41.4)	19,0 (42.4)
36,0 (120)	25,9 (56.9)	26,9 (59.2)	27,8 (61.2)	28,9 (63.4)	27,2 (60.0)	14,4 (31.6)	15,2 (33.4)	15,9 (35.0)	16,7 (36.8)	17,2 (37.9)
44,0 (150)	22,7 (48.4)	23,6 (49.2)	22,9 (47.6)	21,8 (45.3)	21,4 (44.5)	13,0 (28.1)	13,7 (29.8)	14,5 (31.4)	15,3 (33.2)	15,8 (34.4)
56,0 (180)	— (33.8)	15,3 (35.4)	15,1 (35.0)	14,4 (33.1)	14,0 (32.2)			12,9 (28.8)	13,6 (30.5)	14,2 (31.7)
64,0 (210)			10,7 (23.7)	10,1 (22.3)	10,0 (22.2)				11,2 (24.9)	11,3 (25.1)
72,0 (240)				6,7 (13.9)	6,6 (13.8)					7,6 (15.8)
80,0 (260)				3,9 (9.3)	3,9 (9.2)					
84,0 (280)					2,7 (5.3)					

Meets ANSI B30.5 Requirements - Capacities do not exceed 75% of static tipping load.

NOTICE: This capacity chart is for reference only and must not be used for lifting purposes.

Fixed jib load charts

Liftcrane jib capacities - 2250 Series 3

Jib No. 132 with 6 096 mm (20 ft) strut on Boom No. 44 with heavy-lift top

113 040 kg (249,200 lb) Crane counterweight 54 430 kg (120,000 lb) Carbody counterweight
360° Rating kg (lb) x 1 000

Boom m (ft) Radius	5° Offset					30° Offset				
	39,6 (130)	48,8 (160)	57,9 (190)	70,1 (220)	76,2 (250)	39,6 (130)	48,8 (160)	57,9 (190)	70,1 (220)	76,2 (250)
Jib length 30,5 m (100 ft)	18,3 (60)	18,3 (40.5)								
20,0 (70)	17,9 (38.8)	18,3 (39.7)	— (40.5)							
24,0 (80)	16,9 (37.3)	17,4 (38.3)	17,8 (39.2)	18,1 (39.9)	— (40.6)					
30,0 (100)	15,7 (34.4)	16,2 (35.7)	16,7 (36.8)	17,1 (37.6)	17,4 (38.4)	11,9 (26.1)	— (26.8)			
40,0 (130)	13,6 (30.3)	14,4 (32.0)	15,0 (33.4)	15,6 (34.6)	16,0 (35.5)	9,9 (22.1)	10,4 (23.2)	10,8 (24.1)	11,2 (24.9)	11,5 (25.6)
52,0 (160)	11,6 (26.8)	12,4 (28.6)	13,2 (30.2)	13,8 (31.6)	14,4 (32.8)	8,3 (19.3)	8,8 (20.4)	9,3 (21.4)	9,7 (22.2)	10,0 (23.0)
60,0 (190)	10,6 (24.0)	11,4 (25.8)	12,1 (27.4)	12,8 (28.8)	13,2 (30.1)	— (17.2)	8,1 (18.3)	8,5 (19.3)	8,9 (20.2)	9,2 (20.9)
68,0 (220)		10,5 (23.5)	10,7 (24.5)	10,1 (23.2)	9,9 (22.8)		— (16.8)	7,9 (17.7)	8,3 (18.5)	8,6 (19.3)
76,0 (250)			7,6 (16.7)	7,0 (15.4)	6,8 (15.0)				7,8 (17.2)	8,1 (18.0)
84,0 (280)				4,5 (9.2)	4,3 (8.9)					5,6 (11.6)
92,0 (300)					2,3 (5.4)					

Boom m (ft) Radius	5° Offset					30° Offset				
	39,6 (130)	48,8 (160)	57,9 (190)	70,1 (220)	76,2 (250)	39,6 (130)	48,8 (160)	57,9 (190)	70,1 (220)	76,2 (250)
Jib length 36,6 m (120 ft)	18,3 (60)	14,8 (32.8)								
20,0 (70)	14,5 (31.2)	14,8 (32.1)	— (32.8)							
24,0 (80)	13,5 (29.6)	14,0 (30.7)	14,3 (31.5)	14,7 (32.3)	— (32.8)					
30,0 (100)	12,1 (26.6)	12,7 (27.9)	13,2 (28.9)	13,6 (29.9)	13,9 (30.6)					
40,0 (130)	10,1 (22.5)	10,8 (24.0)	11,4 (25.3)	11,9 (26.4)	12,3 (27.4)	7,4 (16.6)	7,7 (17.2)	7,9 (17.6)	8,1 (18.0)	8,3 (18.4)
52,0 (160)	8,1 (19.0)	8,9 (20.7)	9,5 (22.1)	10,1 (23.4)	10,6 (24.5)	6,3 (14.5)	6,6 (15.2)	6,9 (15.8)	7,1 (16.3)	7,3 (16.8)
60,0 (190)	7,1 (16.3)	7,8 (17.9)	8,5 (19.4)	9,1 (20.7)	9,6 (21.9)	5,7 (13.0)	6,0 (13.7)	6,3 (14.3)	6,6 (14.9)	6,8 (15.4)
68,0 (220)	6,2 (14.1)	6,9 (15.6)	7,6 (17.1)	8,2 (18.4)	8,8 (19.6)	— (12.0)	5,6 (12.5)	5,9 (13.1)	6,1 (13.7)	6,3 (14.2)
76,0 (250)		6,2 (13.8)	6,8 (15.1)	7,4 (16.4)	7,2 (15.9)			5,5 (12.2)	5,7 (12.7)	6,0 (13.2)
84,0 (280)			5,7 (11.9)	5,0 (10.4)	4,8 (9.8)				5,4 (12.1)	5,7 (12.5)
92,0 (310)				2,9 (5.3)	2,7 (4.9)					4,1 —

Meets ANSI B30.5 Requirements - Capacities do not exceed 75% of static tipping load.

NOTICE: This capacity chart is for reference only and must not be used for lifting purposes.

Fixed jib range diagram

No. 132 Fixed jib on No. 44 Long-reach boom

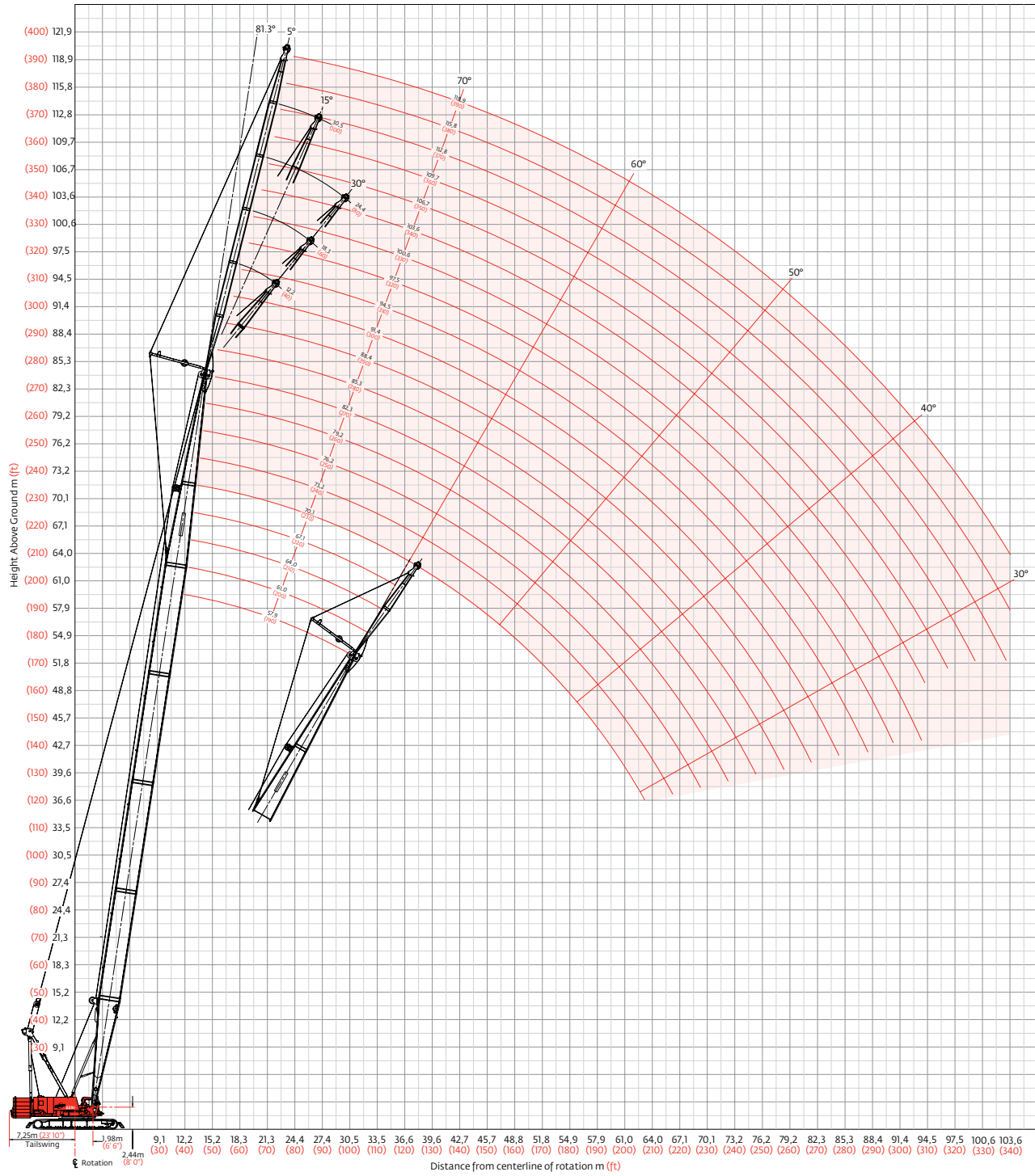

Fixed jib load charts

Liftcrane jib capacities - 2250 Series 3

Jib No. 132 with 6 096 mm (20 ft) strut on boom No. 44 with long-reach top

113 040 kg (249,200 lb) Crane counterweight 360° Rating 54 430 kg (120,000 lb) Carbody counterweight
kg (lb) x1 000

Boom m (ft) Radius	5° Offset					30° Offset				
	57,9 (190)	64,0 (210)	70,1 (230)	79,2 (260)	85,3 (280)	57,9 (190)	64,0 (210)	70,1 (230)	79,2 (260)	85,3 (280)
13,7 (45)	45,3 (100.0)									
16,0 (55)	43,7 (94.5)	44,6 (96.9)	— (90.0)							
22,0 (70)	38,1 (85.3)	39,3 (87.9)	40,3 (90.0)	40,8 (90.0)	37,1 (82.3)	25,2 (56.1)	25,5 (56.7)	25,8 (57.2)		
30,0 (100)	32,8 (71.9)	34,1 (74.6)	35,2 (77.1)	36,7 (80.5)	35,3 (77.8)	22,1 (48.5)	22,7 (49.9)	23,3 (51.1)	24,1 (52.9)	24,6 (53.9)
40,0 (130)	27,4 (61.3)	26,9 (60.3)	26,4 (59.1)	25,6 (57.4)	25,1 (56.2)	19,3 (42.9)	20,0 (44.3)	20,6 (45.7)	21,4 (47.5)	21,9 (48.6)
48,0 (160)	21,0 (45.4)	20,6 (44.4)	20,0 (43.2)	19,3 (41.5)	18,7 (40.2)	17,7 (38.9)	18,4 (40.3)	18,9 (41.5)	19,7 (43.0)	19,5 (41.9)
56,0 (190)	16,2 (33.3)	16,1 (33.1)	15,6 (32.4)	14,8 (30.9)	14,2 (29.6)	16,6 (—)	16,5 (34.5)	16,0 (33.4)	15,3 (31.9)	14,8 (30.8)
68,0 (220)		10,1 (23.2)	9,8 (22.5)	9,3 (21.4)	8,8 (20.3)				10,0 (23.0)	9,5 (22.1)
76,0 (250)			6,7 (14.8)	6,3 (13.9)	5,8 (12.8)					6,4 (14.1)
84,0 (270)				3,9 (9.7)	3,4 (8.8)					
88,0 (290)					2,4 (5.1)					

Boom m (ft) Radius	5° Offset					30° Offset				
	57,9 (190)	64,0 (210)	70,1 (230)	79,2 (260)	85,3 (280)	57,9 (190)	64,0 (210)	70,1 (230)	79,2 (260)	85,3 (280)
16,8 (55)	33,3 (73.5)									
20,0 (65)	32,1 (71.1)	32,5 (72.0)	32,9 (72.7)							
24,0 (80)	30,9 (67.9)	31,3 (68.9)	31,7 (69.9)	32,2 (70.8)	27,2 (60.0)	— (39.9)	— (40.6)			
34,0 (110)	28,2 (62.5)	28,7 (63.7)	28,0 (62.4)	27,4 (61.0)	26,7 (59.4)	15,6 (34.7)	16,0 (35.6)	16,3 (36.3)	16,8 (37.4)	17,1 (38.0)
44,0 (140)	24,3 (55.7)	23,9 (55.1)	23,4 (54.0)	22,6 (52.4)	22,1 (51.2)	13,8 (30.9)	14,2 (31.8)	14,6 (32.7)	15,1 (33.8)	15,4 (34.5)
52,0 (170)	19,0 (42.3)	18,6 (41.3)	18,0 (40.1)	17,3 (38.5)	16,8 (37.3)	12,7 (28.2)	13,1 (29.0)	13,5 (29.9)	14,0 (31.0)	14,3 (31.7)
60,0 (200)	15,0 (32.0)	14,7 (31.6)	14,2 (30.6)	13,5 (28.9)	12,9 (27.7)		12,3 (27.0)	12,6 (27.7)	13,1 (28.8)	13,4 (29.4)
72,0 (230)	— (22.7)	9,4 (22.5)	9,1 (21.7)	8,5 (20.5)	8,0 (19.4)				9,4 (22.5)	9,0 (21.7)
80,0 (260)			6,3 (14.6)	5,8 (13.5)	5,3 (12.4)					— (14.0)
88,0 (290)				3,6 (7.8)	3,1 (6.8)					
92,0 (300)					2,1 (5.1)					

Meets ANSI B30.5 Requirements - Capacities do not exceed 75% of static tipping load.

NOTICE: This capacity chart is for reference only and must not be used for lifting purposes.

Fixed jib load charts

Liftcrane jib capacities - 2250 Series 3

Jib No. 132 with 6 096 mm (20 ft) strut on Boom No. 44 with long-reach top

113 040 kg (249,200 lb) Crane counterweight 54 430 kg (120,000 lb) Carbody counterweight
360° Rating kg (lb) x1 000

Boom m (ft) Radius	5° Offset					30° Offset				
	57,9 (190)	64,0 (210)	70,1 (230)	76,2 (250)	82,3 (270)	57,9 (190)	64,0 (210)	70,1 (230)	76,2 (250)	82,3 (270)
19,8 (65)	18,6 (41.1)									
22,0 (75)	18,2 (39.8)	18,4 (40.3)	— (40.7)	— (41.1)						
30,0 (100)	16,7 (36.7)	16,9 (37.3)	17,2 (37.8)	17,4 (38.3)	17,6 (38.8)					
38,0 (125)	15,3 (33.9)	15,7 (34.6)	16,0 (35.3)	16,2 (35.9)	16,5 (36.4)	10,5 (23.2)	10,7 (23.7)	10,9 (24.2)	11,1 (24.6)	11,3 (25.0)
44,0 (150)	14,4 (31.1)	14,7 (32.0)	15,1 (32.8)	15,4 (33.6)	15,7 (34.2)	9,7 (20.9)	9,9 (21.5)	10,1 (22.0)	10,3 (22.4)	10,5 (22.9)
52,0 (180)	13,1 (28.2)	13,6 (29.1)	14,0 (30.0)	14,3 (30.9)	14,7 (31.6)	8,7 (18.8)	9,0 (19.4)	9,2 (19.9)	9,5 (20.4)	9,6 (20.8)
64,0 (210)	11,6 (25.7)	12,1 (26.7)	12,5 (27.6)	12,7 (28.0)	12,1 (26.8)	7,7 (17.7)	8,0 (17.7)	8,2 (18.2)	8,4 (18.7)	8,6 (19.1)
72,0 (240)	10,8 (23.3)	10,7 (22.7)	10,2 (21.8)	9,9 (21.0)	9,4 (19.8)		7,5 (16.4)	7,7 (16.9)	7,9 (17.3)	8,1 (17.8)
84,0 (270)	— (16.6)	6,8 (16.1)	6,4 (15.2)	6,0 (14.4)	5,5 (13.3)				7,2 (16.3)	6,9 (16.5)
88,0 (290)			5,3 (11.6)	5,0 (10.8)	4,4 (9.7)					5,6 (12.2)
96,0 (320)				3,0 (6.1)	2,6 (5.1)					

Boom m (ft) Radius	5° Offset					30° Offset				
	57,9 (190)	64,0 (210)	70,1 (230)	76,2 (250)	82,3 (270)	57,9 (190)	64,0 (210)	70,1 (230)	76,2 (250)	82,3 (270)
21,3 (70)	14,8 (32.8)									
28,0 (90)	13,5 (30.1)	13,8 (30.7)	14,0 (31.2)	14,2 (31.7)	14,4 (32.1)					
36,0 (120)	12,0 (26.4)	12,3 (27.1)	12,6 (27.8)	12,9 (28.4)	13,1 (28.9)	8,3 (18.2)	8,3 (18.4)	— (18.6)		
44,0 (140)	10,7 (24.1)	11,0 (24.9)	11,4 (25.7)	11,7 (26.3)	12,0 (26.9)	7,5 (16.9)	7,6 (17.2)	7,7 (17.4)	7,9 (17.7)	8,0 (17.9)
52,0 (170)	9,5 (21.1)	9,9 (22.0)	10,3 (22.8)	10,6 (23.5)	10,9 (24.2)	6,8 (15.2)	7,0 (15.5)	7,1 (15.8)	7,2 (16.1)	7,4 (16.4)
60,0 (200)	8,5 (18.5)	8,9 (19.4)	9,2 (20.2)	9,6 (21.0)	10,0 (21.8)	6,3 (13.8)	6,4 (14.2)	6,6 (14.5)	6,7 (14.8)	6,9 (15.1)
72,0 (230)	7,2 (16.3)	7,6 (17.2)	7,9 (18.0)	8,3 (18.8)	8,7 (19.6)	5,6 (12.9)	5,8 (13.1)	6,0 (13.4)	6,1 (13.8)	6,2 (14.1)
80,0 (260)	6,5 (14.5)	6,8 (15.3)	7,2 (16.2)	7,5 (17.0)	7,0 (16.0)	— (12.0)	5,5 (12.3)	5,6 (12.6)	5,8 (12.9)	5,9 (13.2)
88,0 (290)	5,9 (13.1)	6,1 (13.4)	5,7 (12.4)	5,3 (11.5)	4,8 (10.4)			5,4 (12.0)	5,5 (12.2)	5,6 (12.5)
96,0 (320)			3,8 (7.8)	3,4 (7.0)	2,9 (5.8)					4,1 (8.2)
100,0 (340)				2,6 (4.3)	2,1 (—)					

Meets ANSI B30.5 Requirements - Capacities do not exceed 75% of static tipping load.

NOTICE: This capacity chart is for reference only and must not be used for lifting purposes.

Luffing jib range diagram

No. 133A or 133 Luffing jib on No.44 Heavy-lift boom

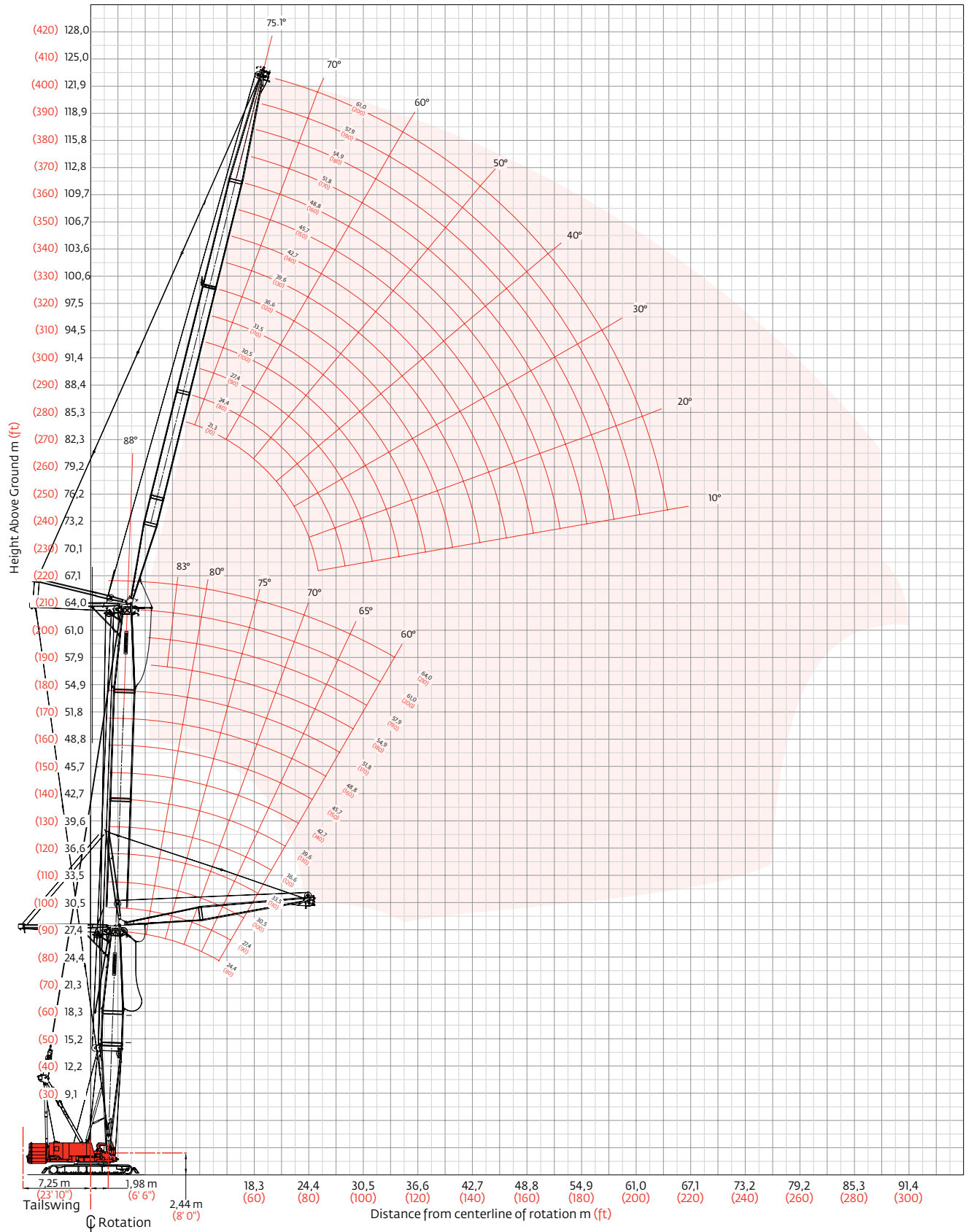

Luffing jib load charts

Liftcrane luffing jib capacities - 2250 Series 3 Luffing jib No. 133 or No. 133A on Boom No. 44 with heavy-lift top

113 040 kg (249,200 lb) Counterweight 54 430 kg (120,000 lb) Carbody counterweight
360° Rating kg (lb) x 1 000

88° Boom angle

Luffing jib length	Boom m (ft) Radius	24,4 (80)	33,5 (110)	42,7 (140)	51,8 (170)	61,0 (200)
	21,3 m (70 ft)	9,8 (32)	95,2 (210.0)			
11,0 (36)		86,9 (192.0)	83,1 (183.3)	82,5 (182.0)		
12,0 (40)		80,6 (175.3)	78,8 (172.2)	78,7 (172.0)	— (148.7)	— (131.6)
14,0 (45)		69,0 (156.1)	70,9 (159.8)	71,6 (160.7)	62,6 (139.7)	55,7 (124.3)
16,0 (55)		56,9 (117.7)	58,6 (120.9)	60,6 (124.2)	57,9 (124.1)	51,8 (111.4)
22,0 (70)		37,0 (85.0)	37,7 (86.7)	38,4 (88.5)	39,4 (90.8)	40,5 (93.0)
26,0 (85)						
30,0 (100)						
34,0 (110)						
36,0 (120)						

Luffing jib length	Boom m (ft) Radius	24,4 (80)	33,5 (110)	42,7 (140)	51,8 (170)	61,0 (200)
	33,5 m (110 ft)	9,8 (32)				
11,0 (36)						
12,0 (40)		— (159.8)	— (151.4)			
14,0 (45)		65,5 (146.8)	63,7 (142.2)	62,4 (139.0)	55,1 (122.7)	47,1 (104.7)
16,0 (55)		58,1 (122.4)	58,8 (125.8)	58,1 (124.8)	51,5 (110.9)	44,4 (95.6)
22,0 (70)		38,1 (87.8)	38,9 (89.6)	39,7 (91.5)	41,1 (94.2)	35,6 (80.7)
26,0 (85)		30,4 (67.4)	30,9 (68.6)	31,5 (69.8)	32,2 (71.4)	30,0 (66.6)
30,0 (100)		25,0 (54.1)	25,4 (54.8)	25,8 (55.7)	26,3 (56.8)	25,3 (54.7)
34,0 (110)		21,0 (47.4)	21,3 (48.0)	21,6 (48.7)	22,0 (49.6)	21,5 (48.3)
36,0 (120)		18,0 (35.8)	19,0 (39.7)	19,7 (42.0)	20,1 (43.2)	19,9 (43.2)

Luffing jib length	Boom m (ft) Radius	24,4 (80)	33,5 (110)	42,7 (140)	51,8 (170)	61,0 (200)
	48,8 m (160 ft)	16,0 (55)	— (102.6)	— (99.5)	— (96.3)	— (82.1)
20,0 (65)		42,8 (95.2)	42,0 (93.1)	41,0 (90.8)	34,9 (77.3)	29,4 (65.1)
24,0 (80)		33,8 (72.9)	34,4 (74.3)	35,7 (76.6)	31,5 (68.7)	26,6 (58.2)
30,0 (100)		24,6 (53.2)	25,0 (54.0)	25,6 (55.3)	25,9 (56.2)	22,2 (48.4)
36,0 (120)		18,8 (40.7)	19,1 (41.3)	19,6 (42.2)	19,8 (42.7)	18,2 (39.4)
42,0 (140)		14,8 (32.0)	15,2 (32.7)	15,4 (33.3)	15,6 (33.7)	14,9 (32.1)
50,0 (160)		10,8 (25.6)	11,1 (26.4)	11,6 (26.8)	11,7 (27.1)	11,6 (26.5)
56,0 (180)						
60,0 (200)						
64,0 (210)						

Luffing jib length	Boom m (ft) Radius	24,4 (80)	33,5 (110)	42,7 (140)	51,8 (170)	61,0 (200)
	61,0 m (200 ft)	16,0 (55)				
20,0 (65)		32,7 (72.5)	32,0 (70.9)	29,7 (65.8)	26,0 (57.6)	22,3 (49.5)
24,0 (80)		28,9 (63.0)	28,6 (62.5)	28,1 (61.6)	24,5 (53.9)	21,1 (46.3)
30,0 (100)		23,4 (50.9)	23,5 (51.1)	23,6 (51.3)	21,8 (47.7)	18,8 (41.0)
36,0 (120)		18,2 (39.2)	18,4 (39.7)	18,7 (40.3)	18,8 (40.9)	16,2 (35.4)
42,0 (140)		14,2 (30.5)	14,4 (31.0)	14,6 (31.4)	14,9 (32.1)	13,8 (30.0)
50,0 (160)		10,4 (24.2)	10,6 (24.6)	10,8 (24.9)	11,0 (25.4)	11,0 (25.3)
56,0 (180)		8,4 (19.3)	8,6 (19.8)	8,7 (20.0)	8,8 (20.4)	8,9 (20.6)
60,0 (200)		7,2 (15.4)	7,4 (15.8)	7,5 (16.2)	7,7 (16.5)	7,8 (16.6)
64,0 (210)		4,6 (10.3)	5,4 (12.1)	5,9 (13.1)	6,0 (13.4)	6,3 (14.1)

Meets ANSI B30.5 Requirements - Capacities do not exceed 75% of static tipping load.

NOTICE: This capacity chart is for reference only and must not be used for lifting purposes.

Luffing jib load charts

Liftcrane luffing jib capacities - 2250 Series 3 Luffing jib No. 133 or No. 133A on Boom No. 44 with heavy-lift top

113 040 kg (249,200 lb) Counterweight 54 430 kg (120,000 lb) Carbody counterweight
360° Rating kg (lb) x 1 000

75° Boom angle

Luffing jib length (70 ft)	Boom m (ft) Radius	24,4 (80)	33,5 (110)	42,7 (140)	51,8 (170)	61,0 (200)
	20,0 (65)	66,2 (148.5)				
22,0 (70)	55,0 (128.6)	61,5 (140.9)				
24,0 (80)	47,0 (100.9)	55,1 (119.3)	— (115.8)			
28,0 (90)	36,1 (82.5)	41,9 (96.2)	44,2 (100.1)	42,7 (96.7)		
30,0 (100)		36,9 (79.2)	40,6 (87.9)	39,2 (84.9)	36,4 (78.8)	
36,0 (120)				31,2 (67.6)	28,9 (62.5)	
42,0 (140)						
46,0 (150)						
48,0 (160)						
50,0 (170)						

Luffing jib length (110 ft)	Boom m (ft) Radius	24,4 (80)	33,5 (110)	42,7 (140)	51,8 (170)	61,0 (200)
	20,0 (65)					
22,0 (70)						
24,0 (80)						
28,0 (90)	37,3 (85.2)	43,5 (99.6)				
30,0 (100)	33,2 (71.3)	38,1 (81.7)	— (85.9)			
36,0 (120)	24,6 (52.9)	27,5 (59.0)	31,1 (66.4)	30,1 (65.1)	27,7 (59.9)	
42,0 (140)		21,0 (45.2)	23,2 (49.9)	24,6 (53.2)	22,5 (48.8)	
46,0 (150)			— (44.0)	21,7 (48.5)	19,9 (44.4)	
48,0 (160)				20,1 (43.0)	18,7 (40.5)	
50,0 (170)					17,7 (36.8)	

Luffing jib length (160 ft)	Boom m (ft) Radius	24,4 (80)	33,5 (110)	42,7 (140)	51,8 (170)	61,0 (200)
	30,0 (100)					
34,0 (110)	26,7 (60.3)					
36,0 (120)	24,2 (52.0)	27,2 (58.3)	— (66.0)			
42,0 (140)	18,6 (39.9)	20,5 (44.1)	23,0 (49.3)	23,4 (50.6)	21,1 (45.6)	
48,0 (160)	14,6 (31.5)	16,1 (34.7)	17,8 (38.2)	19,4 (41.8)	17,4 (37.5)	
54,0 (180)	11,7 (25.2)	13,0 (27.9)	14,2 (30.4)	15,5 (33.2)	14,5 (31.3)	
60,0 (200)			11,5 (24.7)	12,5 (26.7)	12,2 (26.4)	
68,0 (220)					— (22.1)	
72,0 (240)						
76,0 (260)						

Luffing jib length (200 ft)	Boom m (ft) Radius	24,4 (80)	33,5 (110)	42,7 (140)	51,8 (170)	61,0 (200)
	30,0 (100)					
34,0 (110)						
36,0 (120)						
42,0 (140)	17,9 (38.4)	19,9 (42.6)	— (46.8)			
48,0 (160)	13,9 (29.9)	15,4 (33.0)	17,0 (36.3)	18,2 (39.2)	16,4 (35.3)	
54,0 (180)	11,1 (23.7)	12,2 (26.1)	13,3 (28.5)	14,8 (31.6)	13,5 (29.1)	
60,0 (200)	8,9 (19.0)	9,8 (20.9)	10,7 (22.8)	11,7 (25.1)	11,3 (24.2)	
68,0 (220)	6,6 (15.1)	7,4 (16.9)	8,0 (18.4)	8,8 (20.1)	8,9 (20.3)	
72,0 (240)			7,0 (14.8)	7,6 (16.3)	7,9 (16.9)	
76,0 (260)				6,6 (—)	7,0 (13.7)	

Meets ANSI B30.5 Requirements - Capacities do not exceed 75% of static tipping load.

NOTICE: This capacity chart is for reference only and must not be used for lifting purposes.

Luffing jib load charts

Liftcrane luffing jib capacities - 2250 Series 3 Luffing jib No. 133 or No. 133A on Boom No. 44 with heavy-lift top

113 040 kg (249,200 lb) Counterweight 54 430 kg (120,000 lb) Carbody counterweight
360° Rating kg (lb) x 1 000

60° Boom angle

Luffing jib length	Boom m (ft) Radius	24,4 (80)	33,5 (110)	42,7 (140)	51,8 (170)	61,0 (200)
	21,3 m (70 ft)	30,0 (100)	— (87.1)			
34,0 (110)		34,4 (77.4)				
36,0 (120)			30,3 (65.6)			
38,0 (130)			28,3 (59.2)	— (55.3)		
42,0 (140)				23,2 (50.3)		
48,0 (160)					17,9 (38.9)	— (34.0)
54,0 (180)						
56,0 (190)						
60,0 (200)						
64,0 (210)						

Luffing jib length	Boom m (ft) Radius	24,4 (80)	33,5 (110)	42,7 (140)	51,8 (170)	61,0 (200)
	33,5 m (110 ft)	30,0 (100)				
34,0 (110)						
36,0 (120)						
38,0 (130)		— (60.8)				
42,0 (140)		24,6 (52.8)	— (52.0)			
48,0 (160)			20,2 (43.7)	18,6 (40.2)		
54,0 (180)				15,9 (34.2)	14,0 (30.3)	
56,0 (190)				15,0 —	13,3 (27.9)	
60,0 (200)					11,9 (25.6)	9,9 (21.3)
64,0 (210)						8,8 (19.6)

Luffing jib length	Boom m (ft) Radius	24,4 (80)	33,5 (110)	42,7 (140)	51,8 (170)	61,0 (200)
	48,8 m (160 ft)	50,0 (160)	17,1 (39.7)			
54,0 (170)		14,6 (35.1)	16,0 —			
56,0 (180)		13,6 (31.3)	15,1 (34.5)			
58,0 (200)		12,6 (25.1)	14,3 (29.3)	12,8 (26.1)		
68,0 (220)			— (24.4)	9,7 (22.1)	8,2 (18.7)	6,3 (14.4)
72,0 (230)				— (20.4)	7,3 (17.2)	5,5 (13.1)
76,0 (250)					6,5 (14.3)	4,8 (10.9)
80,0 (270)						4,2 —
84,0 (280)						
88,0 (290)						

Luffing jib length	Boom m (ft) Radius	24,4 (80)	33,5 (110)	42,7 (140)	51,8 (170)	61,0 (200)
	61,0 m (200 ft)	50,0 (160)				
54,0 (170)						
56,0 (180)						
58,0 (200)		11,9 (23.6)	— (26.9)			
68,0 (220)		8,2 (18.9)	9,9 (22.6)	8,6 (19.7)		
72,0 (230)		7,1 (16.9)	8,6 (20.3)	7,7 (18.0)	6,1 (14.5)	
76,0 (250)			7,4 (16.4)	6,8 (15.1)	5,4 (11.9)	3,6 (8.0)
80,0 (270)				6,0 (12.5)	4,7 (9.6)	3,0 (6.1)
84,0 (280)					4,1 (8.6)	2,5 (5.2)
88,0 (290)					3,5 (7.6)	2,0 (4.3)

Meets ANSI B30.5 Requirements - Capacities do not exceed 75% of static tipping load.

NOTICE: This capacity chart is for reference only and must not be used for lifting purposes.

Fixed jib on luffing jib range diagram

No. 140 Fixed jib on No. 133A or 133 Luffing jib on No. 44 Heavy-lift boom

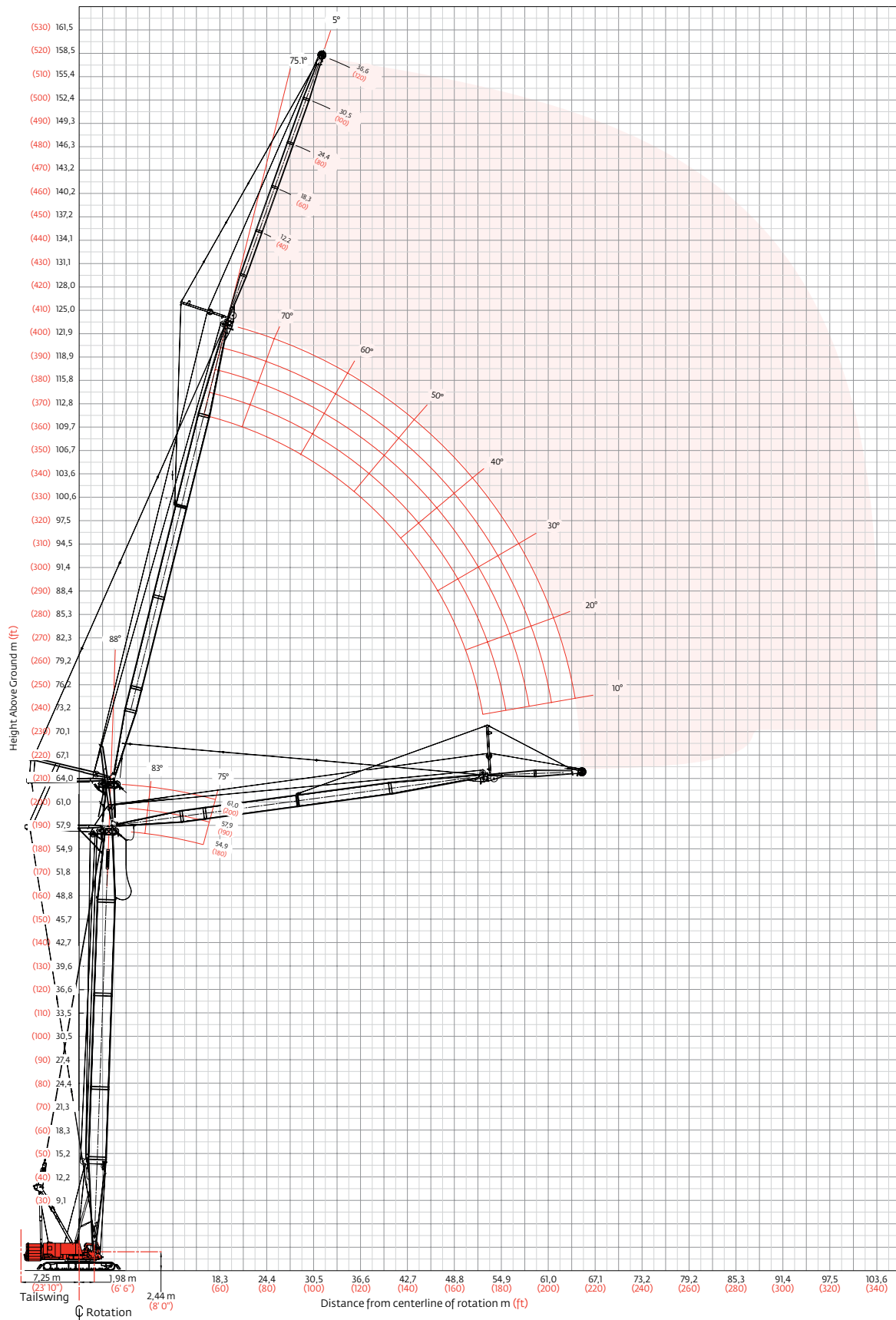

Fixed jib on luffing jib load charts

Liftcrane fixed jib on luffing capacities - 2250 Series 3
Fixed jib No. 140 Set at 5 Degree offset angle on
Luffing jib No. 133 or No. 133A on Boom No. 44 with heavy-lift top

113 040 kg (249,200 lb) Counterweight 54 430 kg (120,000 lb) Carbody counterweight
 360° Rating kg (lb) x1 000
88° Boom angle

Luffing jib m (ft)	48,8 (160)				51,8 (170)			57,9 (190)			61,0 (200)		
	Boom m (ft)	Radius	21,3 (70)	26,0 (90)	32,0 (110)	38,0 (130)	44,0 (150)	50,0 (170)	56,0 (190)	64,0 (210)	68,0 (230)	76,0 (250)	
Fixed jib length 12,2 m (40 ft) 5° offset	54,9 (180)	57,9 (190)	61,0 (200)	54,9 (180)	57,9 (190)	61,0 (200)	54,9 (180)	57,9 (190)	61,0 (200)	54,9 (180)	57,9 (190)	61,0 (200)	
	21,4 (47.2)	19,4 (43.7)	19,0 (42.0)	19,9 (44.0)	18,5 (40.8)	17,8 (39.4)							
	19,5 (41.7)	18,1 (38.6)	17,3 (37.1)	18,3 (39.3)	17,0 (36.4)	16,3 (35.0)	15,9 (34.4)	14,8 (32.0)	14,2 (30.7)	13,5 (30.0)	13,5 (29.7)	13,2 (28.6)	
	16,8 (35.5)	15,6 (33.0)	14,9 (31.7)	16,0 (33.9)	14,8 (31.5)	14,2 (30.2)	14,2 (30.4)	13,2 (28.3)	12,7 (27.1)	13,3 (28.7)	12,4 (26.6)	11,9 (25.6)	
	14,1 (29.5)	13,1 (27.5)	12,6 (26.5)	13,5 (28.5)	12,6 (26.6)	12,1 (25.5)	12,4 (26.2)	11,5 (24.4)	11,0 (23.4)	11,8 (25.1)	10,9 (23.3)	10,5 (22.3)	
	11,6 (24.2)	10,8 (22.7)	10,4 (21.8)	11,3 (23.6)	10,5 (22.1)	10,1 (21.2)	10,5 (22.2)	9,8 (20.6)	9,4 (19.8)	10,1 (21.5)	9,4 (19.9)	9,0 (19.1)	
	9,5 (19.8)	8,9 (18.6)	8,6 (18.0)	9,3 (19.4)	8,7 (18.2)	8,4 (17.5)	8,8 (18.5)	8,2 (17.2)	7,9 (16.5)	8,6 (18.1)	8,0 (16.8)	7,6 (16.1)	
	7,8 (16.2)	7,3 (15.3)	7,1 (14.8)	7,7 (16.0)	7,2 (15.0)	6,9 (14.5)	7,3 (15.4)	6,8 (14.3)	6,6 (13.8)	7,2 (15.1)	6,7 (14.1)	6,4 (13.5)	
	5,7 (12.6)	5,8 (12.8)	5,6 (12.4)	5,8 (13.0)	5,6 (12.5)	5,4 (12.0)	5,3 (11.8)	5,3 (11.9)	5,1 (11.4)	5,3 (11.9)	5,3 (11.7)	5,0 (11.2)	
				4,1 —	4,3 —	4,4 —	4,4 (8.8)	4,4 (8.9)	4,5 (8.9)	4,4 (8.7)	4,4 (8.7)	4,4 (8.8)	
										2,6 (5.6)	2,6 (5.7)	2,7 (5.9)	
	Fixed jib length 36,6 m (120 ft) 5° offset	54,9 (180)	57,9 (190)	61,0 (200)	54,9 (180)	57,9 (190)	61,0 (200)	54,9 (180)	57,9 (190)	61,0 (200)	54,9 (180)	57,9 (190)	61,0 (200)
		28,0 (95)	— (21.0)										
9,1 (19.7)		8,9 (19.4)	8,9 (19.3)	8,9 (19.3)	8,7 (18.9)	8,4 (18.3)	8,1 (17.6)	7,6 (16.6)	7,4 (16.1)	7,5 (16.5)	7,1 (15.5)	— (15.0)	
8,3 (18.0)		8,3 (17.9)	8,2 (17.7)	8,2 (17.7)	8,1 (17.6)	7,9 (17.0)	7,6 (16.6)	7,2 (15.6)	6,9 (15.1)	7,1 (15.5)	6,7 (14.5)	6,4 (14.1)	
7,6 (16.4)		7,5 (16.3)	7,5 (16.3)	7,5 (16.3)	7,4 (16.1)	7,2 (15.5)	7,1 (15.3)	6,6 (14.4)	6,4 (13.9)	6,6 (14.4)	6,2 (13.5)	6,0 (13.0)	
6,9 (15.1)		6,9 (15.0)	6,8 (14.6)	6,9 (14.9)	6,7 (14.5)	6,5 (14.0)	6,5 (14.0)	6,1 (13.1)	5,8 (12.6)	6,1 (13.2)	5,7 (12.3)	5,5 (11.8)	
6,4 (13.9)		6,3 (13.4)	6,1 (12.9)	6,4 (13.8)	6,0 (12.9)	5,8 (12.4)	5,9 (12.6)	5,5 (11.7)	5,2 (11.2)	5,5 (11.7)	5,2 (11.1)	4,9 (10.6)	
5,7 (12.6)		5,3 (11.8)	5,1 (11.3)	5,5 (12.2)	5,1 (11.4)	4,9 (10.9)	5,0 (11.2)	4,7 (10.4)	4,4 (9.9)	4,8 (10.6)	4,4 (9.8)	4,2 (9.4)	
4,7 (10.2)		4,4 (9.6)	4,2 (9.2)	4,6 (9.9)	4,3 (9.2)	4,1 (8.8)	4,2 (8.9)	3,9 (8.5)	3,7 (8.1)	4,0 (8.3)	3,7 (8.1)	3,5 (7.7)	
3,6 (7.1)		3,6 (7.2)	3,5 (7.2)	3,3 (6.7)	3,4 (6.7)	3,3 (6.7)	2,8 (5.4)	2,8 (5.5)	2,8 (5.5)	2,5 (4.8)	2,5 (4.9)	2,5 (4.9)	
2,2 (4.6)		2,2 (4.7)	2,3 (4.9)	2,1 (4.7)	2,2 (4.8)	2,2 (4.8)							

Meets ANSI B30.5 Requirements - Capacities do not exceed 75% of static tipping load.

NOTICE: This capacity chart is for reference only and must not be used for lifting purposes.

Fixed jib on luffing jib load charts

Liftcrane fixed jib on luffing capacities - 2250 Series 3
Fixed jib No. 140 Set at 5 Degree offset angle on
Luffing jib No. 133 or No. 133A on Boom No. 44 with heavy-lift top

113 040 kg (249,200 lb) Counterweight 54 430 kg (120,000 lb) Carbody counterweight
 360° Rating kg (lb) x 1 000
83° Boom angle

Luffing jib m (ft)	48,8 (160)			51,8 (170)			57,9 (190)			61,0 (200)			
	Boom m (ft)	Radius 30,0 (100)		Boom m (ft)	Radius 30,0 (100)		Boom m (ft)	Radius 30,0 (100)		Boom m (ft)	Radius 30,0 (100)		
Fixed jib length 12,2 m (40 ft) 5° offset	54,9 (180)	57,9 (190)	61,0 (200)	54,9 (180)	57,9 (190)	61,0 (200)	54,9 (180)	57,9 (190)	61,0 (200)	54,9 (180)	57,9 (190)	61,0 (200)	
	34,0 (115)	22,0 (47.9)	20,3 (44.2)	19,5 (42.4)	20,5 (44.7)	19,0 (41.4)	18,2 (39.7)	17,5 (38.4)	16,3 (35.7)	— (34.2)	— (30.0)	— (30.0)	
	38,0 (130)	20,6 (44.2)	19,0 (40.8)	18,3 (39.2)	19,4 (41.8)	17,9 (38.6)	17,3 (37.1)	16,9 (36.6)	15,7 (34.0)	15,0 (32.6)	13,6 (30.0)	13,6 (30.0)	13,6 (30.0)
	44,0 (150)	16,9 (34.5)	16,7 (35.1)	16,1 (34.1)	16,7 (34.1)	16,0 (34.0)	15,4 (32.8)	15,5 (32.8)	14,4 (30.8)	13,8 (29.7)	13,6 (30.0)	13,4 (29.0)	13,0 (27.9)
	50,0 (170)	13,0 (26.7)	13,2 (27.1)	13,4 (27.5)	12,8 (26.2)	13,0 (26.6)	13,2 (27.0)	12,2 (25.0)	12,4 (25.4)	12,3 (25.8)	12,9 (26.2)	12,2 (26.0)	11,7 (25.0)
	56,0 (190)	10,2 (20.9)	10,3 (21.2)	10,5 (21.5)	10,0 (20.4)	10,1 (20.7)	10,3 (21.0)	9,4 (19.2)	9,5 (19.5)	9,7 (19.8)	9,8 (19.8)	9,9 (20.2)	10,1 (20.5)
	64,0 (210)	7,4 (16.4)	7,5 (16.6)	7,6 (16.9)	7,2 (15.9)	7,3 (16.2)	7,4 (16.4)	6,6 (14.7)	6,8 (15.0)	6,8 (15.2)	6,8 (15.0)	6,8 (15.2)	7,0 (15.5)
	68,0 (230)	6,3 (11.7)	6,4 (12.4)	6,5 (13.0)	6,1 (12.4)	6,2 (12.6)	6,3 (12.8)	5,5 (11.2)	5,6 (11.4)	5,7 (11.6)	5,6 (11.2)	5,7 (11.4)	5,8 (11.6)
	76,0 (250)							3,8 (8.3)	3,8 (8.4)	3,9 (8.6)	3,7 (8.1)	3,8 (8.3)	3,8 (8.5)
	80,0 (270)										2,9 (5.1)	2,9 (5.5)	3,0 (5.8)

Luffing jib m (ft)	48,8 (160)			51,8 (170)			57,9 (190)			61,0 (200)			
	Boom m (ft)	Radius 40,0 (135)		Boom m (ft)	Radius 40,0 (135)		Boom m (ft)	Radius 40,0 (135)		Boom m (ft)	Radius 40,0 (135)		
Fixed jib length 36,6 m (120 ft) 5° offset	54,9 (180)	57,9 (190)	61,0 (200)	54,9 (180)	57,9 (190)	61,0 (200)	54,9 (180)	57,9 (190)	61,0 (200)	54,9 (180)	57,9 (190)	61,0 (200)	
	44,0 (145)	8,0 (18.4)	7,9 (17.5)	7,9 (17.4)	7,8 (17.3)	7,7 (17.1)	— (16.5)	— (16.3)					
	48,0 (160)	7,5 (16.5)	7,5 (16.4)	7,5 (16.4)	7,4 (16.3)	7,5 (16.9)	7,3 (16.2)	7,1 (15.8)	7,0 (15.5)	7,0 (15.4)	6,9 (15.2)	6,8 (15.0)	6,8 (14.9)
	52,0 (170)	7,1 (15.9)	7,1 (15.8)	7,1 (15.7)	7,1 (15.7)	7,0 (15.6)	7,0 (15.6)	6,8 (15.1)	6,7 (15.0)	6,7 (15.0)	6,6 (14.7)	6,6 (14.6)	6,5 (14.5)
	58,0 (190)	6,6 (14.6)	6,5 (14.5)	6,6 (14.6)	6,5 (14.5)	6,5 (14.4)	6,5 (14.4)	6,3 (14.1)	6,3 (14.0)	6,3 (14.0)	6,2 (13.8)	6,2 (13.7)	6,2 (13.7)
	64,0 (210)	6,1 (13.5)	6,1 (13.5)	6,1 (13.5)	6,0 (13.4)	6,0 (13.4)	6,0 (13.4)	5,9 (13.2)	5,9 (13.1)	5,9 (13.1)	5,8 (12.9)	5,8 (12.9)	5,8 (12.8)
	72,0 (240)	5,6 (12.2)	5,6 (12.2)	5,6 (12.2)	5,5 (12.1)	5,5 (12.1)	5,5 (12.1)	5,3 (11.2)	5,4 (11.4)	5,4 (11.6)	5,0 (10.6)	5,1 (10.8)	5,2 (11.0)
	80,0 (270)	4,4 (8.9)	4,5 (9.1)	4,6 (9.2)	4,2 (8.4)	4,3 (8.6)	4,3 (8.7)	3,6 (7.2)	3,7 (7.3)	3,8 (7.5)	3,4 (6.6)	3,4 (6.7)	3,5 (6.9)
	88,0 (290)	3,0 (6.7)	3,1 (6.9)	3,2 (7.0)	2,8 (6.2)	2,9 (6.4)	3,0 (6.5)	2,3 (5.0)	2,4 (5.2)	2,4 (5.3)	2,0 (4.4)	2,1 (4.5)	2,1 (4.7)
	92,0 (310)	2,5 (4.3)	2,5 (4.7)	2,6 (5.0)	2,3 (4.4)	2,3 (4.5)	2,4 (4.6)						

Meets ANSI B30.5 Requirements - Capacities do not exceed 75% of static tipping load.

NOTICE: This capacity chart is for reference only and must not be used for lifting purposes.

Fixed jib on luffing jib load charts

Liftcrane fixed jib on luffing capacities - 2250 Series 3
Fixed jib No. 140 Set at 5 Degree offset angle on
Luffing jib No. 133 or No. 133A on Boom No. 44 with heavy-lift top

113 040 kg (249,200 lb) Counterweight 54 430 kg (120,000 lb) Carbody counterweight
 360° Rating kg (lb) x 1 000
75° Boom angle

Luffing jib m (ft)	48,8 (160)			51,8 (170)			57,9 (190)			61,0 (200)		
	Boom m (ft)	Radius	Capacity	Boom m (ft)	Radius	Capacity	Boom m (ft)	Radius	Capacity	Boom m (ft)	Radius	Capacity
46,0 (150)	54,9 (180)	18,1 (40.3)		54,9 (180)			54,9 (180)			54,9 (180)		
48,0 (160)	17,5 (38.1)	16,4 (35.7)	15,6 (33.9)	16,8 (36.6)	—	—						
52,0 (170)	15,6 (34.8)	15,0 (33.3)	14,3 (31.8)	15,4 (34.3)	14,6 (32.4)	13,8 (30.7)	14,3 (31.7)	13,3 (29.6)	12,6 (28.0)	13,6 (30.0)		
58,0 (190)	12,8 (28.4)	12,3 (27.4)	11,9 (26.5)	12,6 (27.9)	12,1 (26.9)	11,7 (26.0)	12,0 (26.6)	11,4 (25.3)	11,0 (24.4)	12,6 (28.0)	11,8 (26.1)	11,0 (24.5)
64,0 (210)	10,0 (22.2)	10,2 (22.6)	9,8 (21.8)	9,8 (21.7)	10,0 (22.1)	9,7 (21.4)	9,3 (20.5)	9,3 (20.6)	8,9 (19.8)	9,6 (21.3)	9,6 (21.3)	9,3 (20.5)
68,0 (230)	8,5 (17.4)	8,8 (18.0)	8,7 (18.0)	8,3 (17.0)	8,6 (17.5)	8,5 (17.6)	7,8 (15.7)	8,1 (16.3)	7,8 (16.1)	8,0 (16.1)	8,3 (16.7)	8,0 (16.4)
76,0 (250)	6,2 (13.6)	6,4 (14.1)	6,6 (14.6)	6,0 (13.2)	6,2 (13.7)	6,4 (14.1)	5,4 (12.0)	5,7 (12.5)	5,8 (12.9)	5,5 (12.1)	5,7 (12.5)	5,9 (13.0)
80,0 (270)				5,0 —	5,2 —	5,4 10.8	4,5 (9.0)	4,7 (9.3)	4,9 (9.7)	4,5 (8.8)	4,7 (9.2)	4,8 (9.6)
88,0 (290)									3,2 (7.0)	2,8 (6.2)	3,0 (6.5)	3,1 (6.8)
— (300)											— (5.2)	— (5.6)

Luffing jib m (ft)	48,8 (160)			51,8 (170)			57,9 (190)			61,0 (200)		
	Boom m (ft)	Radius	Capacity	Boom m (ft)	Radius	Capacity	Boom m (ft)	Radius	Capacity	Boom m (ft)	Radius	Capacity
58,0 (195)	— (15.1)											
64,0 (210)	6,4 (14.3)	6,4 (14.3)	6,4 (14.3)	6,3 (14.1)	6,3 (14.1)	6,3 (14.1)	6,0 (13.4)					
66,0 (220)	6,3 (13.8)	6,3 (13.9)	6,3 (13.9)	6,2 (13.7)	6,3 (14.0)	6,2 (13.6)	6,0 (13.1)	5,9 (13.0)	5,9 (13.0)	5,7 (12.7)	— (12.6)	— (12.4)
68,0 (230)	6,1 (13.4)	6,2 (13.4)	6,2 (13.4)	6,1 (13.2)	6,2 (13.2)	6,1 (13.2)	5,8 (12.8)	5,8 (12.7)	5,8 (12.7)	5,7 (12.4)	5,6 (12.3)	5,5 (12.2)
76,0 (250)	5,6 (12.5)	5,7 (12.6)	5,7 (12.6)	5,6 (12.4)	5,6 (12.4)	5,6 (12.5)	5,5 (12.1)	5,4 (12.1)	5,4 (12.0)	5,3 (11.8)	5,3 (11.8)	5,3 (11.7)
80,0 (270)	5,4 (11.8)	5,4 (11.8)	5,4 (11.9)	5,4 (11.7)	5,4 (11.8)	5,4 (11.8)	5,2 (10.5)	5,3 (10.9)	5,2 (11.0)	5,0 (9.9)	5,1 (10.3)	5,0 (10.2)
88,0 (290)	4,3 (9.5)	4,5 (9.8)	4,6 (10.2)	4,1 (9.0)	4,3 (9.3)	4,4 (9.7)	3,6 (7.8)	3,7 (8.1)	3,9 (8.5)	3,3 (7.2)	3,4 (7.5)	3,6 (7.8)
92,0 (310)	3,6 (7.3)	3,8 (7.5)	3,9 (7.8)	3,4 (6.8)	3,5 (7.0)	3,7 (7.3)	2,9 (5.6)	3,0 (5.8)	3,1 (6.1)	2,6 (4.9)	2,7 (5.2)	2,8 (5.5)
100,0 (330)	2,4 (5.3)	2,5 (5.5)	2,7 (5.8)	2,2 (4.8)	2,3 (5.1)	2,4 (5.3)			1,9 (4.1)			
— (340)		— (4.5)	— (4.8)		— (4.2)	— (4.4)						

Meets ANSI B30.5 Requirements - Capacities do not exceed 75% of static tipping load.

NOTICE: This capacity chart is for reference only and must not be used for lifting purposes.

Outline dimensions

MAX-ER® 2000

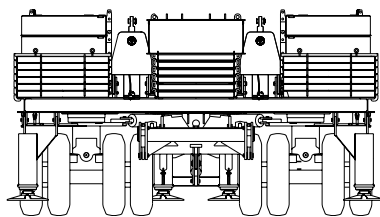
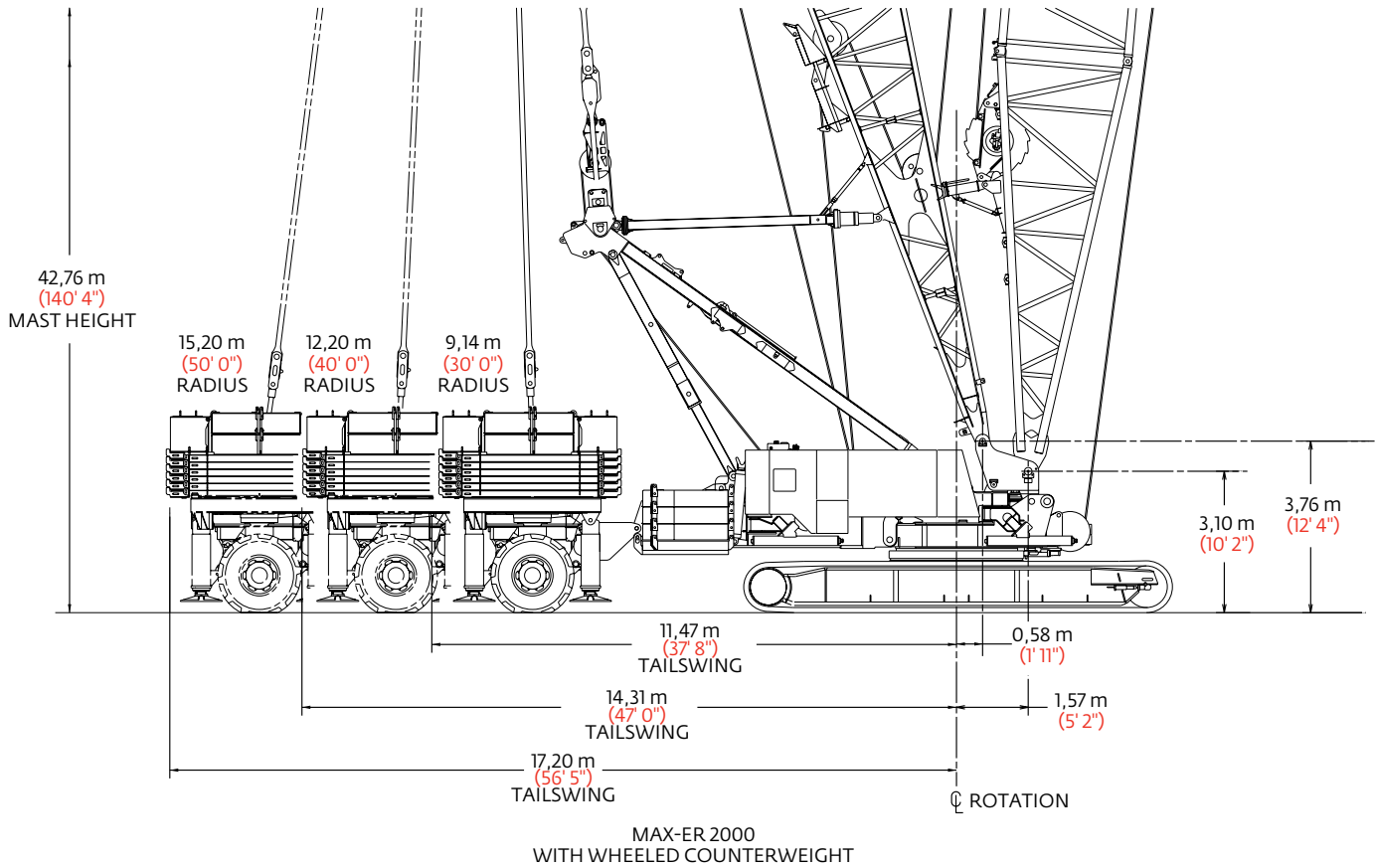

Counterweight arrangement

Outline dimensions

MAX-ER® 2000

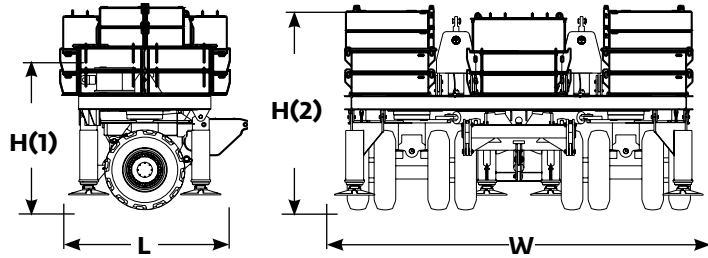

Wheeled carrier and strap cylinders x 1

Length	3,33 m	10' 11"
Width	8,38 m	27' 6"
Height(1)	3,23 m	10' 7"
Height(2)	4,42 m	14' 6"
Weight	35 117 kg	77,420 lb

Note: side view of wheeled carrier shows hydraulic strap cylinders in optional 3,23 m (10' 7") height position for shipping.

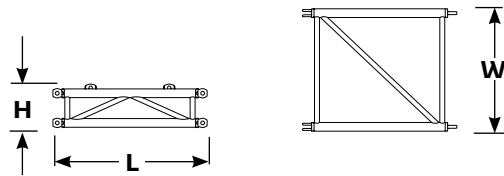

Trailer arm insert 3,0 m (10') x 1, 2

Length	3,17 m	10' 5"
Width	2,51 m	8' 3"
Height	0,89 m	2' 11"
Weight	1163 kg	2,565 lb

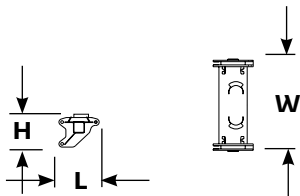

Adapter arm x 1

Length	1,14 m	3' 9"
Width	2,57 m	8' 5"
Height	0,91 m	3' 0"
Weight	1270 kg	2,800 lb

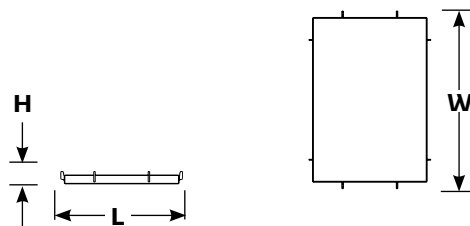

Counterweight box - lower side x 12

Length	2,16 m	7' 1"
Width	3,12 m	10' 4"
Height	0,23 m	0' 9"
Weight	5 897 kg	13,000 lb

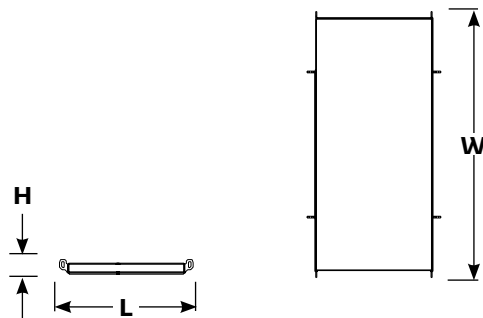

Counterweight box - lower center x 6

Length	1,96 m	6' 5"
Width	3,89 m	12' 9"
Height	0,20 m	0' 8"
Weight	6 441 kg	14,200 lb

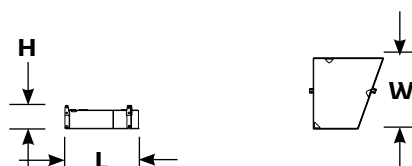

Counterweight box - upper side x 4

Length	2,01 m	6' 7"
Width	1,93 m	6' 4"
Height	0,48 m	1' 7"
Weight	7 030 kg	15,500 lb

Note: Two each of left- and right-side configurations required. Upper side counterweights from Series 3 lifterane.

Option

Outline dimensions

MAX-ER® 2000

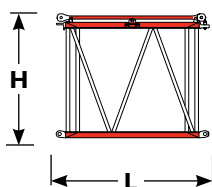
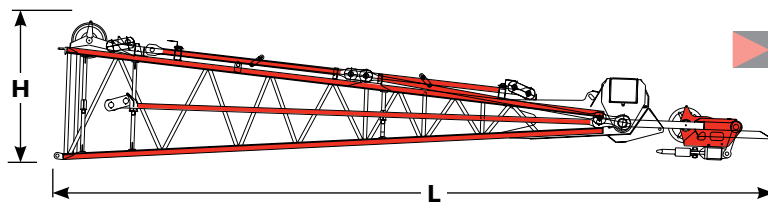
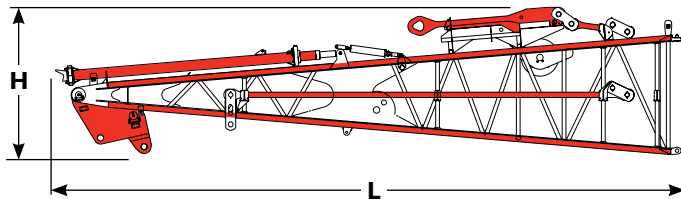
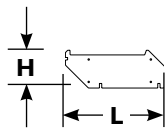
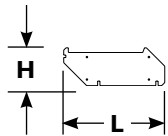
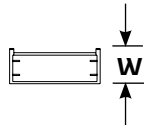
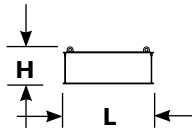

Counterweight box - upper center			x 4
Length	2,18 m	7' 2"	
Width	0,86 m	2' 10"	
Height	0,89 m	2' 11"	
Weight	6 803 kg	15,000 lb	

Note: Carbody side counterweights from Model 2250 Series 3.

Counterweight adaptor plate - front			x 2
Length	1,68 m	5' 6"	
Width	0,08 m	0' 3"	
Height	0,63 m	2' 1"	
Weight	454 kg	1,000 lb	

Counterweight adaptor plate - rear			x 2
Length	2,13 m	7' 0"	
Width	0,05 m	0' 2"	
Height	0,66 m	2' 3"	
Weight	502 kg	1,106 lb	

No. 44 Mast butt 12,2 m (40') and mast and boom adaptor frame, mast stop, beam spreader, sheaves, straps, links			x 1
Length	12,78 m	41' 11"	
Width	3,02 m	9' 11"	
Height	3,00 m	9' 10"	
Weight	10 737 kg	23,760 lb	

No. 44 Mast top assembly 15,2 m (50') and sheaves, straps, links with equalizer			x 1
Length	15,52 m	50' 11"	
Width	3,02 m	9' 11"	
Height	3,05 m	10' 0"	
Weight	12 891 kg	28,420 lb	

No. 44 Mast insert 3,0 m (10') and straps			x 1
Length	3,23 m	10' 7"	
Width	2,59 m	8' 6"	
Height	2,59 m	8' 6"	
Weight	1 016 kg	2,240 lb	

Note: Same as No. 44 3,0 m (10') boom insert.

Option

Outline dimensions

MAX-ER® 2000

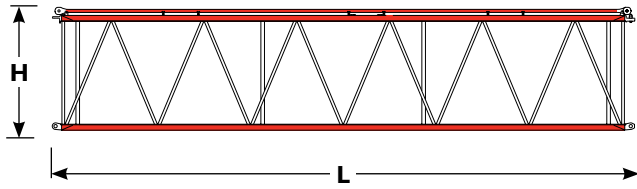

No. 44 Mast insert 12,2 m (40') & Straps			x 1
Length	12,75 m	41' 10"	
Width	2,59 m	8' 6"	
Height	2,59 m	8' 6"	
Weight	2 948 kg	6,500 lb	
<i>Note: Same as No. 44 12,2 m (40') boom insert.</i>			

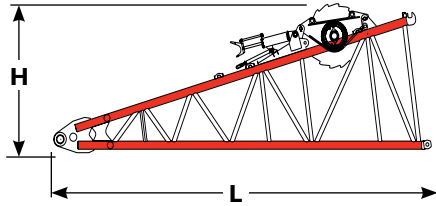

No. 79 Boom butt 9,1 m (30') and main hoist with wire rope, boom stop			x 1
Length	9,42 m	30' 11"	
Width	3,02 m	9' 11"	
Height	3,56 m	11' 8"	
Weight	14 633 kg	32,265 lb	
Weight*	5 517 kg	12,165 lb	
<i>*Weight without main hoist and wire rope.</i>			

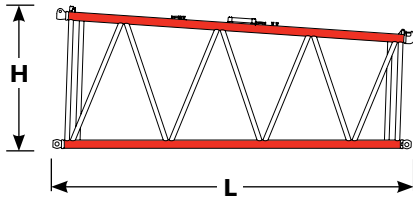

No. 79 Boom transition insert 7,6 m (25') and straps			x 1
Length	7,85 m	25' 9"	
Width	3,02 m	9' 11"	
Height	3,10 m	10' 2"	
Weight	3 653 kg	8,053 lb	

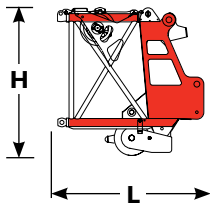

No. 79 Boom top 1,5 m (5') and lower point, wire rope guide, straps			x 1
Length	3,23 m	10' 7"	
Width	2,69 m	8' 10"	
Height	3,12 m	10' 4"	
Weight	7 370 kg	16,248 lb	

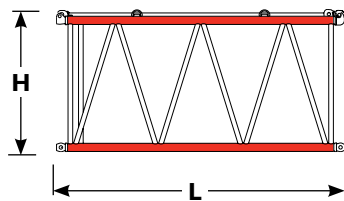

No. 79 Boom insert 6,1 m (20') and straps			x 1
Length	6,27 m	20' 7"	
Width	3,02 m	9' 11"	
Height	3,09 m	10' 2"	
Weight	3 252 kg	7,170 lb	

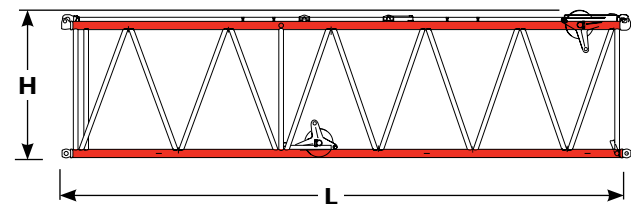

No. 79 Boom insert 12,2 m (40') and sheaves, straps			x 1
Length	12,37 m	40' 7"	
Width	3,02 m	9' 11"	
Height	3,09 m	10' 2"	
Weight	5 438 kg	11,988 lb	

Option

Outline dimensions

MAX-ER® 2000

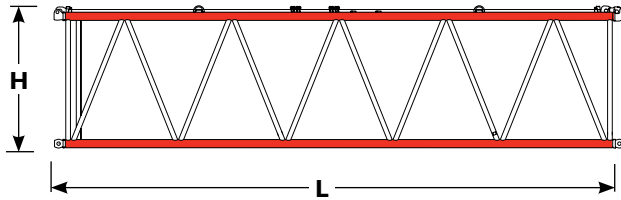

No. 79 Boom insert 12,2 m (40') and straps			x 1, 2, 3, 4	
Length	12,37 m	40' 7"		
Width	3,02 m	9' 11"		
Height	3,09 m	10' 2"		
Weight	5 470 kg	12,060 lb		

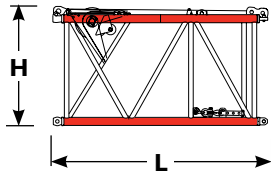

No. 79-44 Transition insert 4,6 m (15') and wire rope guide, straps			x 1	
Length	4,75 m	15' 7"		
Width	2,64 m	8' 8"		
Height	2,59 m	8' 6"		
Weight	3 137 kg	6,915 lb		

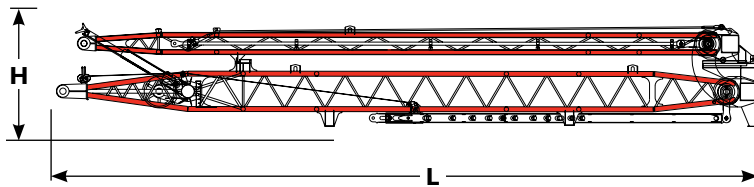

No. 44 Luffing jib mast and strut			x 1	
Length	16,15 m	53' 0"		
Width	2,51 m	8' 3"		
Height	2,36 m	7' 9"		
Weight	10 544 kg	23,245 lb		

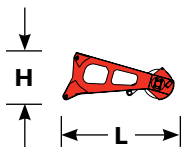

Upper boom point			x 1	
Length	2,18 m	7' 2"		
Width	0,38 m	1' 3"		
Height	1,04 m	3' 5"		
Weight	308 kg	679 lb		

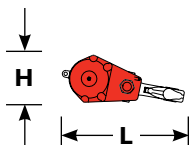

Hook block for 29 mm or (1-1/8") wire rope				
Capacity	272 mt	300 t	Length	2,41 m 7' 11"
Weight	4 268 kg	9,410 lb	Width	1,14 m 3' 9"

Option

Performance data

MAX-ER® 2000

Wire rope lengths Boom No. 79							
Boom length	Whip line Drum 5				Hoist line Drum 9		Maximum required parts of line
	(1 Part of line)		(2 Parts of line)				
m (ft)	m	(ft)	m	(ft)	m	(ft)	
36,6 (120)	91	(300)	130	(425)	1 097	(3,600)	26
42,7 (140)	104	(340)	152	(500)	1 219	(4,000)	26
48,8 (160)	116	(380)	168	(550)	1 280	(4,200)	24
54,9 (180)	128	(420)	191	(625)	1 341	(4,400)	22
61,0 (200)	140	(460)	206	(675)	1 341	(4,400)	20
67,1 (220)	152	(500)	221	(725)	1 341	(4,400)	18
73,2 (240)	165	(540)	244	(800)	1 341	(4,400)	16
79,2 (260)	177	(580)	259	(850)	1 341	(4,400)	14
85,3 (280)	189	(620)	282	(925)	1 341	(4,400)	12
91,4 (300)	201	(660)	297	(975)	1 341	(4,400)	12
97,5 (320)	213	(700)	312	(1,025)	1 341	(4,400)	10
103,6 (340)	226	(740)	335	(1,100)	1 341	(4,400)	8
109,7 (360)	238	(780)	351	(1,150)	1 341	(4,400)	8

Note: Line lengths given in table will allow hook to touch ground. When block travel below ground is required, add additional rope equal to parts of line times added travel distance. Hoisting distance or line pull may be limited when block travel below ground is required.

Performance data

MAX-ER® 2000

Wire rope lengths - MAX-ER on 2250
Luffing jib No. 44 on
Boom No. 79

Boom m (ft)	Hoist line - Drum 9 Lengths in meters (feet) {Parts of line for maximum capacity}																	
	42,7 (140)		48,8 (160)		54,9 (180)		61,0 (200)		67,1 (220)		73,2 (240)		79,2 (260)		85,3 (280)		91,4 (300)	
Luffing jib m (ft)																		
21,3 (70)	1158* (3,800)*	{16}	1006 (3,300)	{12}	1067 (3,500)	{12}	1158* (3,800)*	{12}	1067 (3,500)	{10}	1128 (3,700)	{10}	975 (3,200)	{8}	823 (2,700)	{6}	853 (2,800)	{6}
24,4 (80)	975 (3,200)	{12}	1036 (3,400)	{12}	1128 (3,700)	{12}	1006 (3,300)	{10}	1097 (3,600)	{10}	945 (3,100)	{8}	1006 (3,300)	{8}	823 (2,700)	{6}	884 (2,900)	{6}
27,4 (90)	1006 (3,300)	{12}	1067 (3,500)	{12}	975 (3,200)	{10}	1067 (3,500)	{10}	1128 (3,700)	{10}	975 (3,200)	{8}	1036 (3,400)	{8}	853 (2,800)	{6}	884 (2,900)	{6}
30,5 (100)	1036 (3,400)	{12}	1128 (3,700)	{12}	1006 (3,300)	{10}	1097 (3,600)	{10}	945 (3,100)	{8}	1006 (3,300)	{8}	823 (2,700)	{6}	884 (2,900)	{6}	914 (3,000)	{6}
33,5 (110)	914 (3,000)	{10}	975 (3,200)	{10}	1036 (3,400)	{10}	1128 (3,700)	{10}	975 (3,200)	{8}	1036 (3,400)	{8}	853 (2,800)	{6}	884 (2,900)	{6}	945 (3,100)	{6}
36,6 (120)	945 (3,100)	{10}	1006 (3,300)	{10}	1097 (3,600)	{10}	945 (3,100)	{8}	1006 (3,300)	{8}	1067 (3,500)	{8}	884 (2,900)	{6}	914 (3,000)	{6}	701 (2,300)	{4}
39,6 (130)	975 (3,200)	{10}	1036 (3,400)	{10}	914 (3,000)	{8}	975 (3,200)	{8}	1036 (3,400)	{8}	853 (2,800)	{6}	884 (2,900)	{6}	945 (3,100)	{6}	701 (2,300)	{4}
42,7 (140)	1006 (3,300)	{10}	884 (2,900)	{8}	945 (3,100)	{8}	1006 (3,300)	{8}	1067 (3,500)	{8}	884 (2,900)	{6}	914 (3,000)	{6}	945 (3,100)	{6}	732 (2,400)	{4}
45,7 (150)	853 (2,800)	{8}	914 (3,000)	{8}	975 (3,200)	{8}	1036 (3,400)	{8}	853 (2,800)	{6}	884 (2,900)	{6}	945 (3,100)	{6}	701 (2,300)	{4}	732 (2,400)	{4}
48,8 (160)	884 (2,900)	{8}	945 (3,100)	{8}	1006 (3,300)	{8}	823 (2,700)	{6}	884 (2,900)	{6}	914 (3,000)	{6}	945 (3,100)	{6}	732 (2,400)	{4}	762 (2,500)	{4}
51,8 (170)	914 (3,000)	{8}	975 (3,200)	{8}	792 (2,600)	{6}	853 (2,800)	{6}	884 (2,900)	{6}	945 (3,100)	{6}	701 (2,300)	{4}	732 (2,400)	{4}	762 (2,500)	{4}
54,9 (180)	945 (3,100)	{8}	792 (2,600)	{6}	823 (2,700)	{6}	853 (2,800)	{6}	914 (3,000)	{6}	945 (3,100)	{6}	732 (2,400)	{4}	762 (2,500)	{4}	792 (2,600)	{4}
57,9 (190)	762 (2,500)	{6}	792 (2,600)	{6}	853 (2,800)	{6}	884 (2,900)	{6}	945 (3,100)	{6}	701 (2,300)	{4}	732 (2,400)	{4}	762 (2,500)	{4}	792 (2,600)	{4}
61,0 (200)	792 (2,600)	{6}	823 (2,700)	{6}	853 (2,800)	{6}	914 (3,000)	{6}	701 (2,300)	{4}	732 (2,400)	{4}	762 (2,500)	{4}	792 (2,600)	{4}	823 (2,700)	{4}
64,0 (210)	792 (2,600)	{6}	853 (2,800)	{6}	884 (2,900)	{6}	945 (3,100)	{6}	701 (2,300)	{4}	732 (2,400)	{4}	762 (2,500)	{4}	792 (2,600)	{4}	823 (2,700)	{4}
67,1 (220)	823 (2,700)	{6}	884 (2,900)	{6}	671 (2,200)	{4}	701 (2,300)	{4}	732 (2,400)	{4}	762 (2,500)	{4}	792 (2,600)	{4}	823 (2,700)	{4}	853 (2,800)	{4}
70,1 (230)	853 (2,800)	{6}	884 (2,900)	{6}	671 (2,200)	{4}	701 (2,300)	{4}	732 (2,400)	{4}	762 (2,500)	{4}	792 (2,600)	{4}	823 (2,700)	{4}	853 (2,800)	{4}
73,2 (240)	640 (2,100)	{4}	671 (2,200)	{4}	701 (2,300)	{4}	732 (2,400)	{4}	762 (2,500)	{4}	792 (2,600)	{4}	823 (2,700)	{4}	853 (2,800)	{4}	549 (1,800)	{2}

Note: Line lengths given in table will allow hook to touch ground. When block travel below ground is required, add additional rope equal to parts of line times added travel distance. Hoisting distance or line pull may be limited when block travel below ground is required.

Maximum hoist line length denoted by asterisk (*).

Performance data

MAX-ER® 2000

Wire rope lengths - MAX-ER on 2250 Luffing jib No. 44 on Boom No. 79

Boom and luffing jib length m (ft)	Whip line Drum 3			
	(1 Part of line)		(2 Parts of line)	
	m	(ft)	m	(ft)
64,0 (210)	146	(480)	221	(725)
67,1 (220)	152	(500)	229	(750)
70,1 (230)	158	(520)	236	(775)
73,2 (240)	165	(540)	251	(825)
76,2 (250)	171	(560)	259	(850)
79,2 (260)	177	(580)	267	(875)
82,3 (270)	183	(600)	274	(900)
85,3 (280)	189	(620)	282	(925)
88,4 (290)	195	(640)	290	(950)
91,4 (300)	201	(660)	305	(1,000)
94,5 (310)	207	(680)	312	(1,025)
97,5 (320)	213	(700)	320	(1,050)
100,6 (330)	219	(720)	328	(1,075)
103,6 (340)	226	(740)	335	(1,100)
106,7 (350)	232	(760)	343	(1,125)
109,7 (360)	238	(780)	358	(1,175)
112,8 (370)	244	(800)	366	(1,200)
115,8 (380)	250	(820)	373	(1,225)
118,9 (390)	256	(840)	381	(1,250)
121,9 (400)	262	(860)	389	(1,275)
125,0 (410)	268	(880)	404*	(1,325)*
128,0 (420)	274	(900)	411*	(1,350)*
131,1 (430)	280	(920)	419*	(1,375)*
134,1 (440)	287	(940)	—	—
137,2 (450)	293	(960)	—	—
140,2 (460)	299	(980)	—	—
143,3 (470)	305	(1,000)	—	—
146,3 (480)	311	(1,020)	—	—
149,4 (490)	317	(1,040)	—	—
152,4 (500)	323	(1,060)	—	—
155,5 (510)	329	(1,080)	—	—
158,5 (520)	335	(1,100)		
161,5 (530)	341	(1,120)		
164,6 (540)	347	(1,140)		

Note: Line lengths given in table will allow hook to touch ground. When block travel below ground is required, add additional rope equal to parts of line times added travel distance. Hoisting distance or line pull may be limited when block travel below ground is required.

Wire rope lengths denoted by asterisk (*) require bare drum (lagging removed).

Performance data

MAX-ER® 2000

Wire rope lengths
 Boom No. 79-44
 - or -
 Fixed jib No. 132 on
 Boom No. 79-44

Boom or boom and fixed jib length	Whip line drum 5								Hoist line drum 9		Maximum required parts of line
	(1 Part of line)		(2 Parts of line)		(3 Parts of line)		(4 Parts of line)		m	(ft)	
	m	(ft)	m	(ft)	m	(ft)	m	(ft)			
61,0 (200)	140	(460)	206	(675)	—	—	—	—	1250	(4,100)	18
67,1 (220)	152	(500)	221	(725)	—	—	—	—	1280	(4,200)	17
73,2 (240)	165	(540)	244	(800)	—	—	396	(1,300)	1280	(4,200)	15
79,2 (260)	177	(580)	259	(850)	343	(1,125)	427	(1,400)	1280	(4,200)	13
85,3 (280)	189	(620)	282	(925)	366	(1,200)	457	(1,500)	1280	(4,200)	11
91,4 (300)	201	(660)	297	(975)	389	(1,275)	488	(1,600)	1280	(4,200)	10
97,5 (320)	213	(700)	312	(1,025)	411	(1,350)	518	(1,700)	1280	(4,200)	9
103,6 (340)	226	(740)	335	(1,100)	434	(1,425)	549	(1,800)	1280	(4,200)	7
109,7 (360)	238	(780)	351	(1,150)	457	(1,500)	—	—	1280	(4,200)	6
115,8 (380)	250	(820)	366	(1,200)	488	(1,600)	—	—	1280	(4,200)	6
121,9 (400)	262	(860)	389	(1,275)	511	(1,675)	—	—	1280	(4,200)	5
128,0 (420)	274	(900)	404	(1,325)	533	(1,750)	—	—	—	—	—
134,1 (440)	287	(940)	419	(1,375)	556	(1,825)	—	—	—	—	—
140,2 (460)	293	(960)	442	(1,450)	—	—	—	—	—	—	—
146,3 (480)	305	(1,000)	457	(1,500)	—	—	—	—	—	—	—
152,4 (500)	317	(1,040)	472	(1,550)	—	—	—	—	—	—	—

Note: Hoist line and whip line lengths given in table will allow hook to touch ground. When block travel below ground is required, add additional rope equal to parts of line times added travel distance. Hoisting distance or line pull may be limited when block travel below ground is required.

Maximum hook travel for whip line application may be restricted when line length exceeds 480 m (1,575').

Performance data

MAX-ER® 2000

Wire rope lengths Luffing Jib No. 133A or No. 133 on Boom No. 79-44

Boom or boom and fixed jib length	Luffing jib whip line Drum 3		Luffing jib hoist line Drum 9											
	(1 Part of line)		(7 Parts of line)		(6 Parts of line)		(5 Parts of line)		(4 Parts of line)		(3 Parts of line)		(2 Parts of line)	
	m	(ft)	m	(ft)	m	(ft)	m	(ft)	m	(ft)	m	(ft)	m	(ft)
82,3 (270)	183	(600)	693	(2,275)	—	—	—	—	—	—	—	—	—	—
85,3 (280)	189	(620)	—	—	625	(2,050)	—	—	—	—	—	—	—	—
88,4 (290)	195	(640)	739	(2,425)	648	(2,125)	—	—	—	—	—	—	—	—
91,4 (300)	201	(660)	—	—	610	(2,000)	572	(1,875)	—	—	—	—	—	—
94,5 (310)	207	(680)	792	(2,600)	693	(2,275)	594	(1,950)	—	—	—	—	—	—
97,5 (320)	213	(700)	—	—	709	(2,325)	610	(2,000)	511	(1,675)	—	—	—	—
100,6 (330)	219	(720)	838	(2,750)	732	(2,400)	632	(2,075)	526	(1,725)	—	—	—	—
103,6 (340)	226	(740)	—	—	754	(2,475)	648	(2,125)	541	(1,775)	—	—	—	—
106,7 (350)	232	(760)	—	—	777	(2,550)	671	(2,200)	556	(1,825)	—	—	—	—
109,7 (360)	238	(780)	—	—	—	—	686	(2,250)	572	(1,875)	457	(1,500)	—	—
112,8 (370)	244	(800)	—	—	—	—	701	(2,300)	587	(1,925)	472	(1,550)	—	—
115,8 (380)	250	(820)	—	—	—	—	724	(2,375)	602	(1,975)	480	(1,575)	—	—
118,9 (390)	256	(840)	—	—	—	—	—	—	617	(2,025)	495	(1,625)	—	—
121,9 (400)	262	(860)	—	—	—	—	—	—	632	(2,075)	511	(1,675)	389	(1,275)
125,0 (410)	268	(880)	—	—	—	—	—	—	648	(2,125)	518	(1,700)	396	(1,300)
128,0 (420)	274	(900)	—	—	—	—	—	—	663	(2,175)	533	(1,750)	404	(1,325)
131,1 (430)	280	(920)	—	—	—	—	—	—	—	—	549	(1,800)	411	(1,350)
134,1 (440)	287	(940)	—	—	—	—	—	—	—	—	556	(1,825)	419	(1,375)
137,2 (450)	293	(960)	—	—	—	—	—	—	—	—	572	(1,875)	434	(1,425)
140,2 (460)	299	(980)	—	—	—	—	—	—	—	—	579	(1,900)	442	(1,450)
143,3 (470)	305	(1,000)	—	—	—	—	—	—	—	—	594	(1,950)	450	(1,475)
146,3 (480)	311	(1,020)	—	—	—	—	—	—	—	—	—	—	457	(1,500)
149,4 (490)	317	(1,040)	—	—	—	—	—	—	—	—	—	—	465	(1,525)
152,4 (500)	323	(1,060)	—	—	—	—	—	—	—	—	—	—	480	(1,575)

Note: Line lengths given in table will allow hook to touch ground. When block travel below ground is required, add additional rope equal to parts of line times added travel distance. Hoisting distance or line pull may be limited when block travel below ground is required.

Performance data

MAX-ER® 2000

Wire rope lengths - Fixed jib No. 140 on Luffing jib No. 133A or No. 133 on Boom No. 79-44

Boom, luffing jib and fixed jib length	Fixed jib whip line Drum 3			
	(1 Part of line)		(2 Parts of line)	
	m	(ft)	m	(ft)
140,2 (460)	293	(960)	434	(1,425)
143,3 (470)	299	(980)	442	(1,450)
146,3 (480)	305	(1,000)	450	(1,475)
149,4 (490)	311	(1,020)	465	(1,525)
152,4 (500)	317	(1,040)	472	(1,550)
155,4 (510)	323	(1,060)	480	(1,575)
158,5 (520)	329	(1,080)	488	(1,600)
161,5 (530)	335	(1,100)	495	(1,625)
164,6 (540)	341	(1,120)	511	(1,675)
167,6 (550)	347	(1,140)	518	(1,700)
170,7 (560)	354	(1,160)	526	(1,725)
175,3 (570)	360	(1,180)	—	—
176,8 (580)	366	(1,200)	—	—
179,8 (590)	372	(1,220)	—	—
182,9 (600)	378	(1,240)	—	—
185,9 (610)	384	(1,260)	—	—
189,0 (620)	390	(1,280)	—	—

Note: Line lengths given in table will allow hook to touch ground. When hook travel below ground is required, add additional rope equal to parts of line times added travel distance. Hoisting distance or line pull may be limited when hook travel below ground is required.

Maximum hook travel may be restricted when whip line length exceeds 495 m (1,625') using 622 mm (24-1/2") diameter lagging on Drum 3.

Performance data

MAX-ER® 2000

Wire rope specifications
 Boom No. 79 or No. 79-44
 - or -
 Fixed jib No. 132 on
 Boom No. 79-44
 - or -
 Luffing jib No. 44 on
 Boom No. 79
 - or -
 Luffing jib No. 133A or No. 133 on
 Boom No. 79-44
 - or -
 Fixed jib No. 132 on
 Luffing jib No. 44 on
 Boom No. 79

Function Part number	5:1 Safety factor Right hand regular lay 1960 N/mm ²	5:1 Safety factor Right hand regular lay 2160 N/mm ²	5:1 Safety factor Left hand regular lay 1960 N/mm ²	
	Hoist line No. 719416	Hoist line No. 719421	Whip line No. 719417*	Whip line No. 719375**
Size wire rope	— (1-1/8")	— (1-1/8")	— (1")	— (1-1/8")
Minimum breaking strength	80 190 kg (176,800 lb)	78 830 kg (173,780 lb)	63 320 kg (139,600 lb)	70 260 kg (154,900 lb)
Maximum load per line	15 740 kg (34,000 lb)	15 740 kg (34,000 lb)	12 560 kg (27,700 lb)	13 610 kg (30,000 lb)
Approximate weight	3,84 kg/m (2.58 lb/ft)	4,02 kg/m (2.70 lb/ft)	3,02 kg/m (2.03 lb/ft)	4,02 kg/m (2.70 lb/ft)

*Boom No. 79 and boom No. 79-44.

**Luffing jib No. 44, luffing jib No. 133A or 133, and fixed jib No. 140.

Performance data

MAX-ER® 2000

Drums and laggings - Liftcrane MAX-ER 2000									
	Application	Drums							
		Drum location	Drum part number	Drum type	Drum diameter	Drum width	Grooved lagging part number	Lagging diameter	Wire rope size
Basic liftcrane	Hoist	Boom butt Drum No. 9	Pending 194484	Grooved Grooved	641 mm (25-1/4")	1 244 m (48-63/64")	— —	— —	29 mm (1-1/8")
	Whip	Front of rotating bed Drum No. 5	Pending 193814	Bare Bare	464 mm (18-1/4")	794 mm (31-17/64")	Pending 502407	483 mm (19")	26 mm (1")
Liftcrane luffing jib	Hoist	Boom butt Drum No. 9	Pending 194484	Grooved Grooved	641 mm (25-1/4")	1 244 mm (48-63/64")	— —	— —	29 mm (1-1/8")
	Whip	Left rear Drum No. 3	Pending 171305	Bare Bare	572 mm (22-1/2")	480 mm (18-29/32")	Pending 502401 with Spacer No. 192568 or 196307	622 mm (24-1/2")	29 mm (1-1/8")
Liftcrane Fixed jib No. 44	Hoist	Boom butt Drum No. 9	Pending 194484	Grooved Grooved	641 mm (25-1/4")	1 244 mm (48-63/64")	— —	483 mm (19")	29 mm (1-1/8")
	Hoist	Front of rotating bed Drum No. 5	Pending 193814	Bare Bare	464 mm (18-1/4")	794 mm (31-17/64")	Pending 502407	622 mm (24-1/2")	26 mm (1")
	Whip	Left rear Drum No. 3	Pending 171305	Bare Bare	572 mm (22-1/2")	480 mm (18-29/32")	Pending 502401 with Spacer No. 192568 or 196307	622 mm (24-1/2")	29 mm (1-1/8")

Performance data

MAX-ER® 2000

Maximum length — Unassisted raising

	Luffing jib No. 44 on Boom No. 79 76 750 kg (169,200 lb) Crane counterweight 27 220 kg (60,000 lb) Carbody counterweight 209 560 kg (462,000 lb) Wheeled counterweight at 15,2 m (50') position			
	In-line procedure		Layout jack-knife procedure	
	Main boom	Luffing jib	Main boom	Luffing jib
Over front or rear of blocked crawlers m (ft)	42,7 (140)	21,3 - 73,2 (70 - 240)	—	—
	48,8 (160)	21,3 - 73,2 (70 - 240)	—	—
	54,9 (180)	21,3 - 70,1 (70 - 230)	54,9 (180)	73,2 (240)
	61,0 (200)	21,3 - 61,0 (70 - 200)	61,0 (200)	64,0 - 73,2 (210 - 240)
	67,1 (220)	21,3 - 51,8 (70 - 170)	67,1 (220)	54,9 - 73,2 (180 - 240)
	73,2 (240)	21,3 - 42,7 (70 - 140)	73,2 (240)	45,7 - 73,2 (150 - 240)
	79,2 (260)	21,3 - 33,5 (70 - 110)	79,2 (260)	33,6 - 73,2 (120 - 240)
	—	—	85,3 (280)	21,3 - 73,2 (70 - 240)
	—	—	91,4 (300)	21,3 - 45,7 (70 - 150)
	—	—	91,4* (300)*	48,8 - 64,0 (160 - 210)
	—	—	91,4# (300)#	67,1 - 73,2 (220 - 240)
	—	—	—	—
	—	—	—	—

NOTE: Load block(s), hook(s) and weight ball(s) on ground until boom and luffing jib are erected.

*Remove boom point.

#Remove boom point, rigging winch, and wire rope guides in luffing jib butt.

Maximum length — Unassisted raising

	Luffing jib No. 133A or 133 on Boom No. 79-44 76 750 kg (169,200 lb) Crane counterweight 27 220 kg (60,000 lb) Carbody counterweight 209 560 kg (462,000 lb) Wheeled counterweight at 15,2 m (50') position			
	In-line procedure		Layout jack-knife procedure	
	Main boom	Luffing jib	Main boom	Luffing jib
Over front, rear, or side of blocked crawlers m (ft)	61,0 (200)	21,3 - 61,0 (70 - 200)	—	—
	67,1 (220)	21,3 - 61,0 (70 - 200)	—	—
	73,2 (240)	21,3 - 61,0 (70 - 200)	—	—
	79,2 (260)	21,3 - 61,0 (70 - 200)	—	—
	—	—	85,3 (280)	21,3 - 61,0 (70 - 200)
	—	—	91,4 (300)	21,3 - 61,0 (70 - 200)
	—	—	—	—
	—	—	—	—
	—	—	—	—
	—	—	—	—

NOTE: Load block(s), hook(s) and weight ball(s) on ground until boom and luffing jib are erected.

Maximum length — Unassisted raising

	Fixed jib No. 132 on Boom No. 79-44 76 750 kg (169,200 lb) Crane counterweight 27 220 kg (60,000 lb) Carbody counterweight 209 560 kg (462,000 lb) Wheeled counterweight at 15,2 m (50') position	
	Main boom	Fixed jib
	Over side or end of crawlers m (ft)	121,9 (400)
	115,8 (380)	36,6 (120)

NOTE: Load block(s), hook(s) and weight ball(s) on ground at start.

Maximum length — Unassisted raising

	Fixed jib No. 140 on Luffing jib No. 133A or 133 on Boom No. 79-44 76 750 kg (169,200 lb) Crane counterweight 27 220 kg (60,000 lb) Carbody counterweight 209 560 kg (462,000 lb) Wheeled counterweight at 15,2 m (50') position Layout jack-knife procedure		
	Main boom	Luffing jib	Fixed jib
	Over side or end of blocked crawlers m (ft)	79,2 (260)	48,8 - 61,0 (160 - 200)
85,3 (280)		48,8 - 61,0 (160 - 200)	12,2 - 36,6 (40 - 120)
91,4 (300)		48,8 - 61,0 (160 - 200)	12,2 - 36,6 (40 - 120)

NOTE: Load block(s), hook(s) and weight ball(s) on ground until boom, luffing jib, and fixed jib are erected.

Boom combinations

MAX-ER® 2000

No. 79 Boom combinations				
Boom length m (ft)	Boom inserts			
	6,1 m (20 ft)	12,2 m (40 ft)	12,2 m* (40 ft)*	12,2 m** (40 ft)**
36,6 (120)	1	—	—	—
42,7 (140)	—	—	—	1
48,8 (160)	1	—	—	1
54,9 (180)	—	—	1	1
61,0 (200)	1	—	1	1
67,1 (220)	—	1	1	1
73,2 (240)	1	1	1	1
79,2 (260)	—	2	1	1
85,3 (280)	1	2	1	1
91,4 (300)	—	3	1	1
97,5 (320)	1	3	1	1
103,6 (340)	—	4	1	1
110,0 (360)	1	4	1	1

*Insert without straps.

**Insert with sheaves.

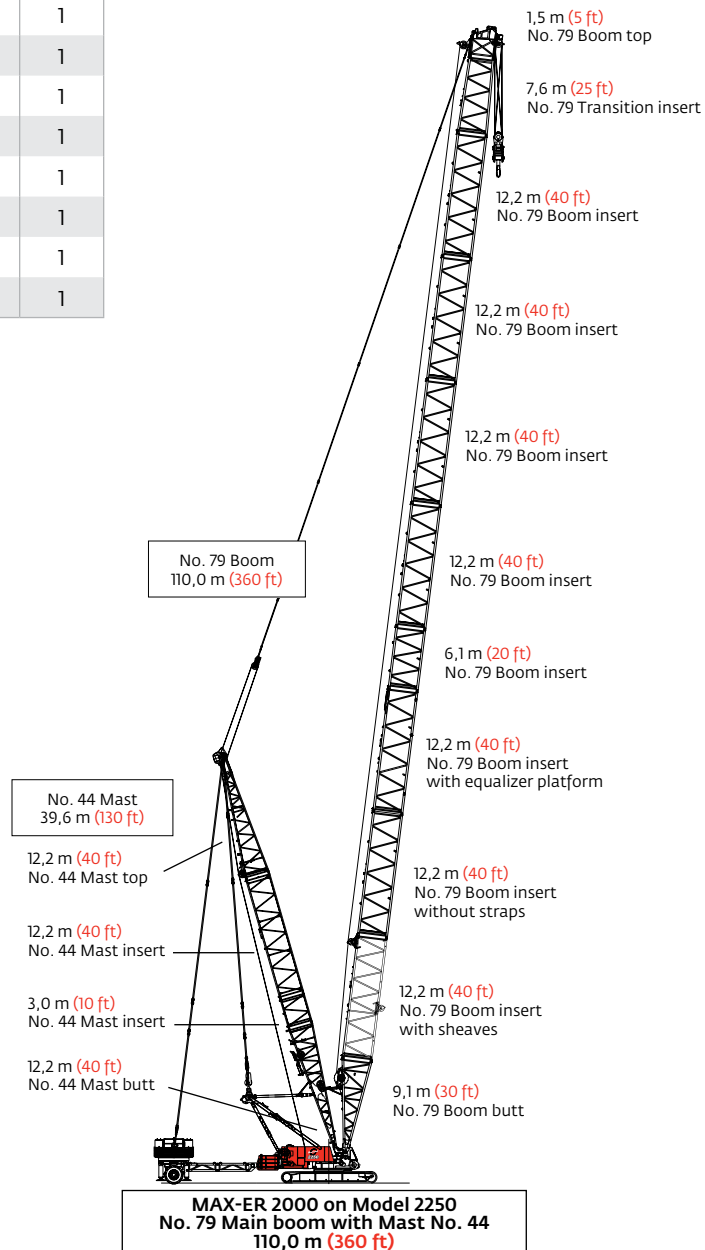

Boom combinations

MAX-ER® 2000

No. 44 Luffing jib combinations

Boom length m (ft)	Boom inserts		
	3,0 m (10 ft)	6,1 m (20 ft)	12,2 m (40 ft)
21,3 (70)	—	—	—
24,4 (80)	1	—	—
27,4 (90)	—	1	—
30,5 (100)	1	1	—
33,5 (110)	—	—	1
36,6 (120)	1	—	1
39,6 (130)	—	1	1
42,7 (140)	1	1	1
45,7 (150)	—	—	2
48,8 (160)	1	—	2
51,8 (170)	—	1	2
54,9 (180)	1	1	2
57,9 (190)	—	—	3
61,0 (200)	1	—	3
64,0 (210)	—	1	3
67,1 (220)	1	1	3
70,1 (230)	—	—	4
73,2 (240)	1	—	4

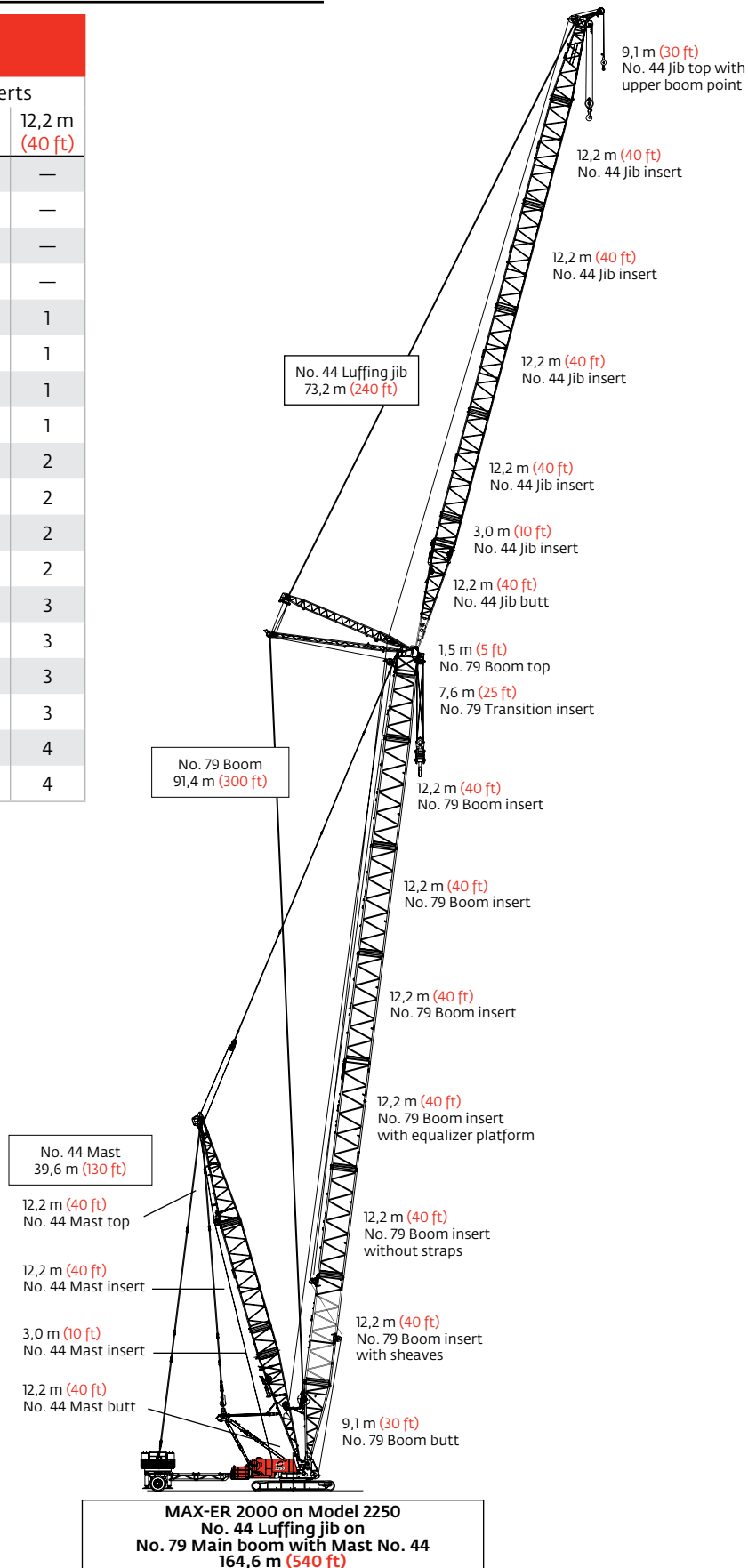

Boom combinations

MAX-ER® 2000

No. 79-44 Long-reach main boom combinations

Boom length m (ft)	Boom inserts				
	No. 79			No. 44	
	6,1 m (20 ft)	12,2 m (40 ft)	12,2 m* (40 ft)*	6,1 m (20 ft)	12,2 m (40 ft)
61,0 (200)	1	—	—	—	—
67,1 (220)	—	—	1	—	—
73,2 (240)	1	—	1	—	—
79,2 (260)	1	—	1	1	—
85,3 (280)	1	—	1	—	1
91,4 (300)	1	—	1	1	1
97,5 (320)	1	1	1	—	1
103,6 (340)	1	1	1	1	1
109,7 (360)	1	1	1	—	2
115,8 (380)	1	1	1	1	2
121,9 (400)	1	1	1	—	3

*Inserts without straps.

Note: Intermediate suspension required for 97,5 m (320') and longer boom lengths.

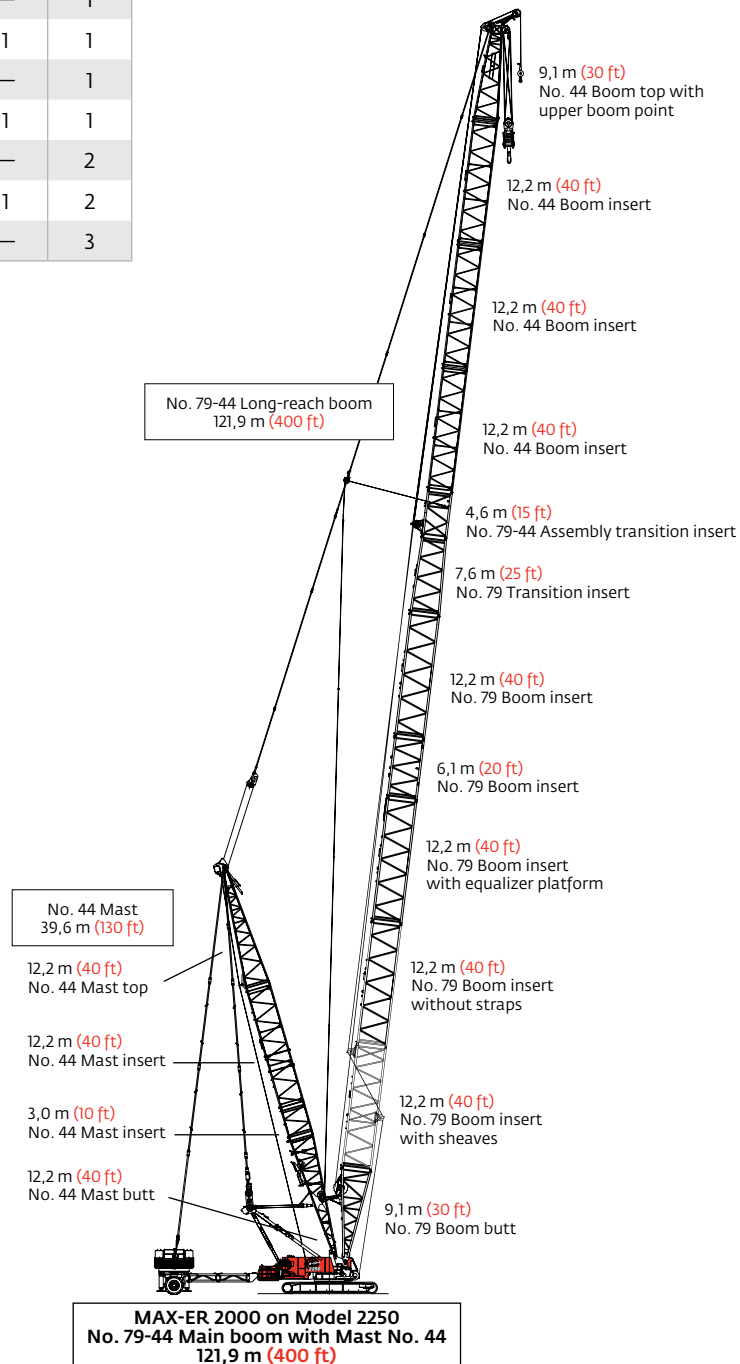

Boom combinations

MAX-ER® 2000

No. 132 Fixed jib combinations

Jib length m (ft)	Fixed jib inserts
6,1 (20)	—
12,2 (40)	1
18,3 (60)	2
24,4 (80)	3
30,5 (100)	4

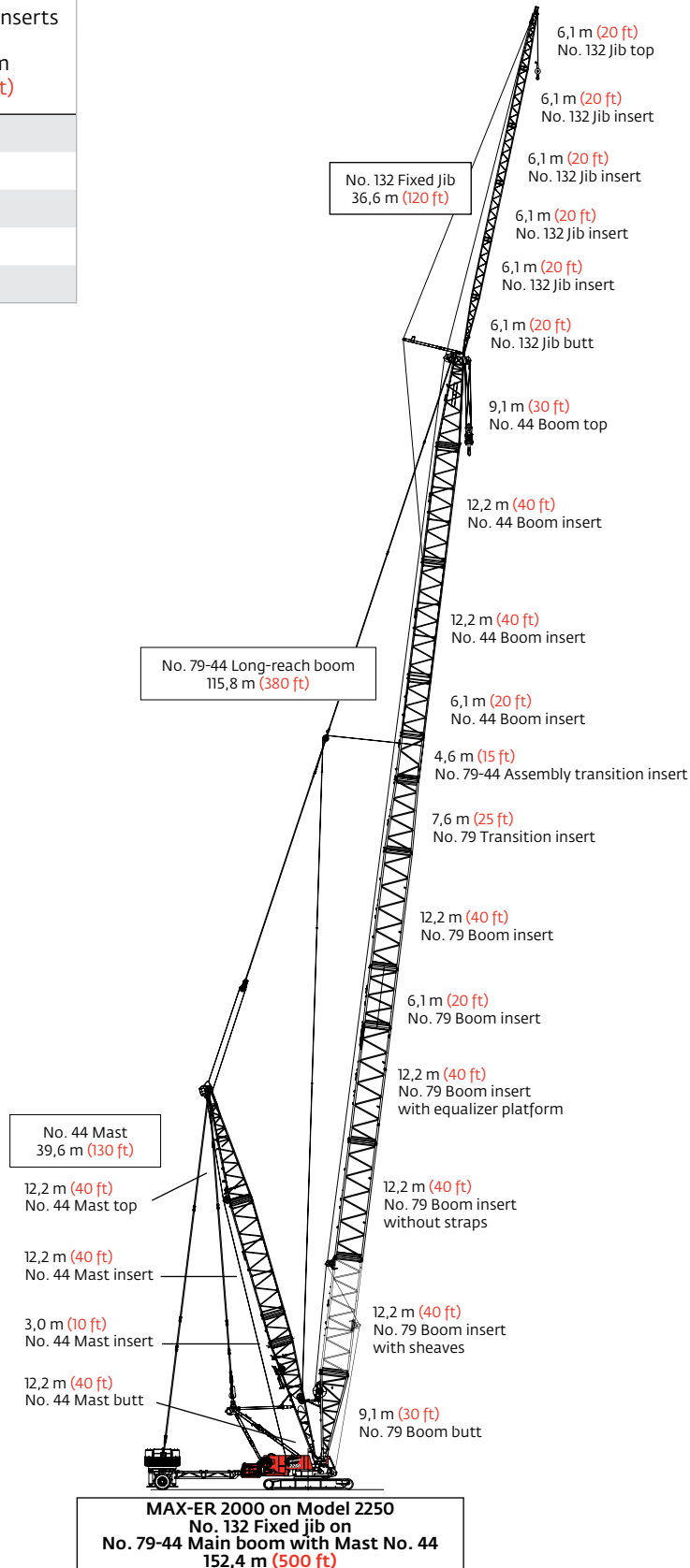

Boom combinations

MAX-ER® 2000

No. 79-44 Main boom combinations

Boom length m (ft)	Boom inserts				
	No. 79			No. 44	
	6,1 m (20 ft)	12,2 m (40 ft)	12,2 m* (40 ft)*	6,1 m (20 ft)	12,2 m (40 ft)
61,0 (200)	1	—	—	—	—
67,1 (220)	—	—	1	—	—
73,2 (240)	1	—	1	—	—
79,2 (260)	1	—	1	1	—
85,3 (280)	1	—	1	—	1
91,4 (300)	1	—	1	1	1
97,5 (320)	1	1	1	—	1
103,6 (340)	1	1	1	1	1
109,7 (360)	1	1	1	—	2
115,8 (380)	1	1	1	1	2
121,9 (400)	1	1	1	—	3

*Inserts without straps.

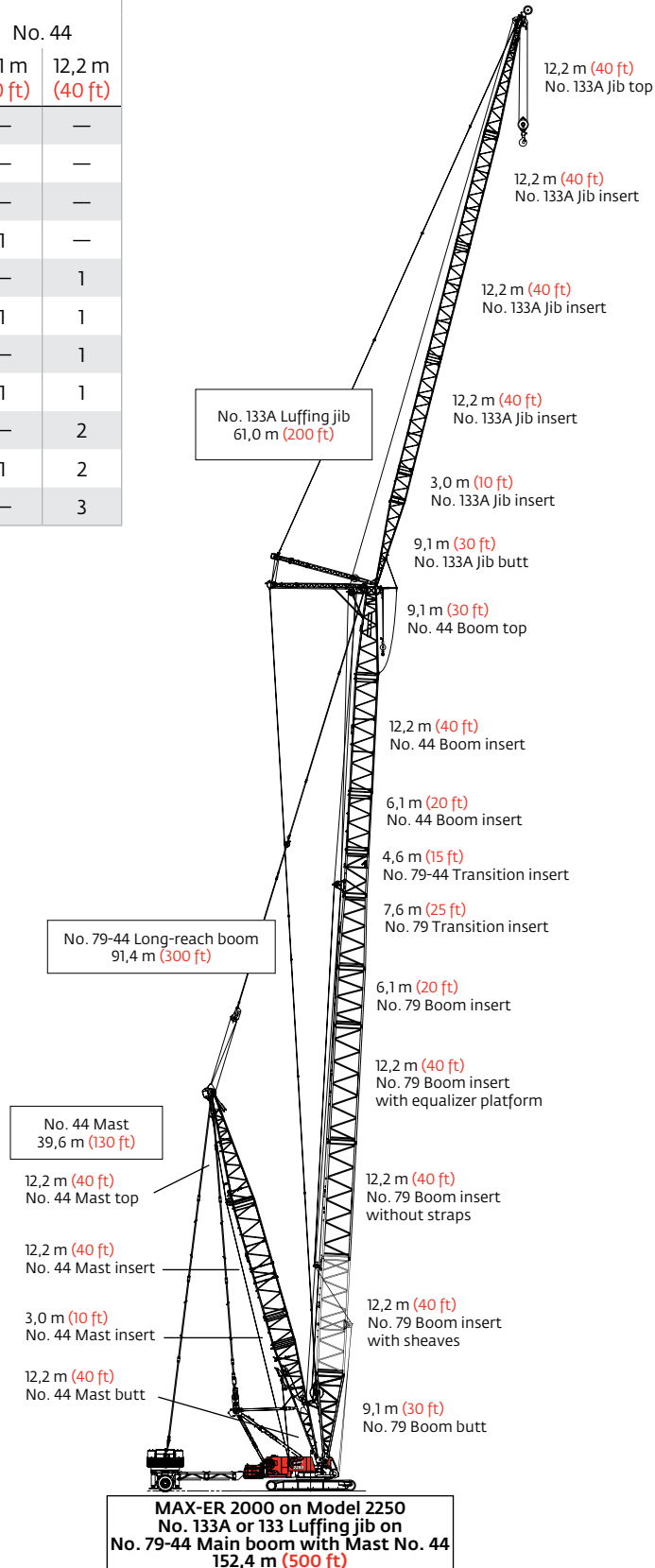

Boom combinations

MAX-ER® 2000

No. 133A or 133 Luffing jib combinations

Luffing jib length m (ft)	Luffing jib inserts		
	3,0 m (10 ft)	6,1 m (20 ft)	12,2 m (40 ft)
21,3 (70)	—	—	—
24,4 (80)	1	—	—
27,4 (90)	—	1	—
30,5 (100)	1	1	—
33,5 (110)	—	—	1
36,6 (120)	1	—	1
39,6 (130)	—	1	1
42,7 (140)	1	1	1
45,7 (150)	—	—	2
48,8 (160)	1	—	2
51,8 (170)	—	1	2
54,9 (180)	1	1	2
57,9 (190)	—	—	3
61,0 (200)	1	—	3

No. 140 Fixed jib combinations

Jib length m (ft)	Fixed jib inserts
	6,1 m (20 ft)
12,2 (40)	—
18,3 (60)	1
24,4 (80)	2
30,5 (100)	3
36,6 (120)	4

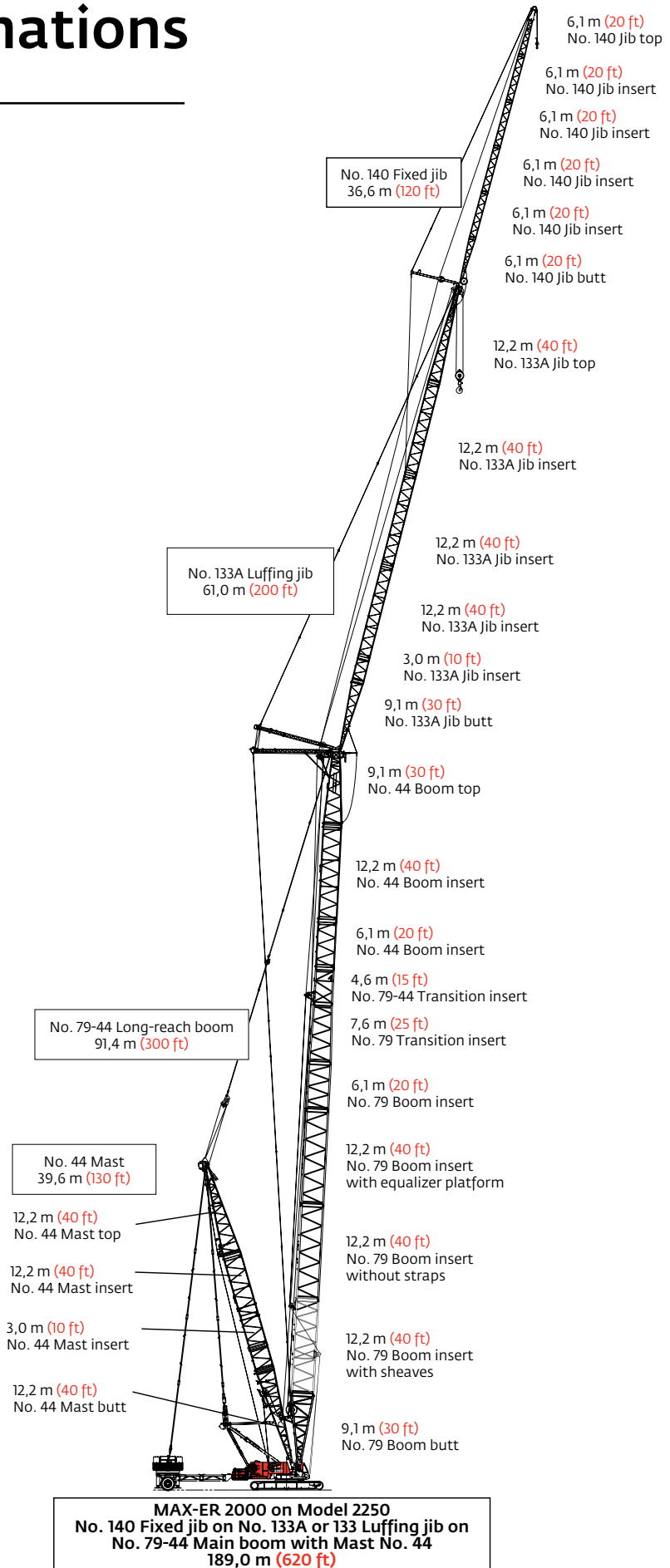

MAX-ER 2000 on Model 2250
No. 140 Fixed jib on No. 133A or 133 Luffing jib on
No. 79-44 Main boom with Mast No. 44
189,0 m (620 ft)

Heavy-lift boom range diagram

MAX-ER® 2000

No. 79 Heavy-lift boom

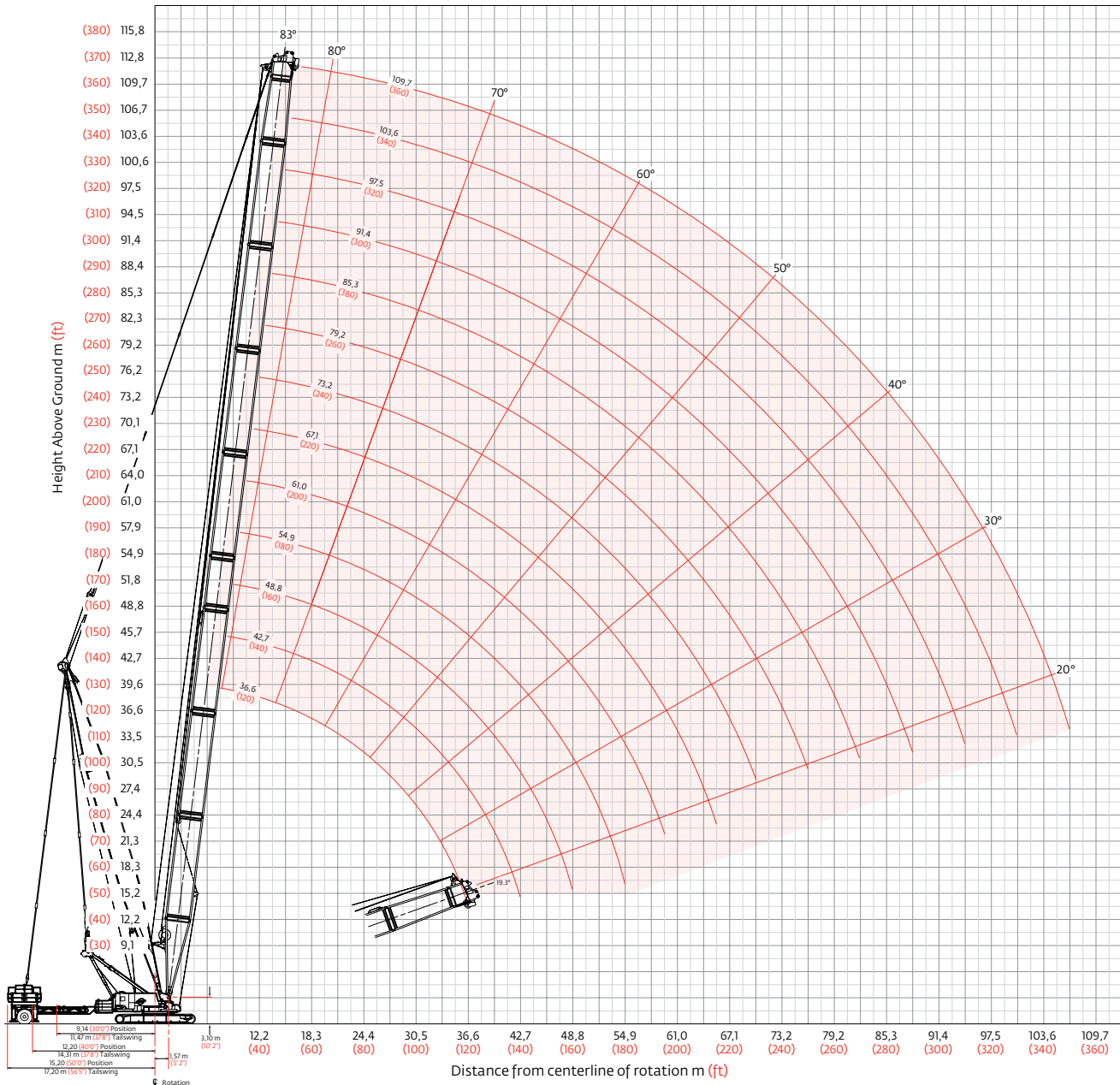

Heavy-lift boom load charts

MAX-ER® 2000

Liftcrane boom capacities - MAX-ER 2000 on 2250												
Boom No. 79 Heavy-lift with 39,6 m (130 ft) Mast No. 44												
Boom m (ft) Radius	76 750 kg (169,200 lb) Crane counterweight, 27 220 kg (60,000 lb) Carbody counterweight 209 560 kg (462,000 lb) Wheeled counterweight at 15,2 m (50 ft) position 360° Rating kg (lb) x 1 000											
	36,6 (120)	42,7 (140)	48,8 (160)	54,9 (180)	61,0 (200)	67,1 (220)	79,2 (260)	85,3 (280)	91,4 (300)	97,5 (320)	103,6 (340)	109,7 (360)
7,6 (25)	450,0 (1000.0)											
9,0 (30)	408,2 (900.0)	398,7 (879.0)	— (791.1)									
10,0 (34)	401,2 (862.1)	395,2 (860.0)	358,8 (791.1)	323,3 (712.9)								
12,0 (40)	338,3 (734.2)	337,4 (732.2)	337,0 (729.4)	323,3 (712.9)	291,4 (642.5)	263,0 (580.0)						
14,0 (50)	289,8 (586.5)	288,9 (584.6)	287,7 (581.9)	287,4 (580.1)	285,9 (577.5)	260,5 (569.9)	207,5 (455.3)	175,6 (387.3)	— (332.0)	— (285.0)		
18,0 (60)	224,1 (486.3)	223,3 (484.5)	222,1 (481.9)	221,3 (480.1)	220,1 (477.5)	219,8 (476.2)	203,5 (448.2)	175,6 (387.3)	150,5 (332.0)	129,2 (285.0)	112,0 (247.0)	97,2 (214.3)
20,0 (70)	200,9 (413.9)	200,1 (412.1)	198,9 (409.6)	198,1 (407.9)	196,9 (405.2)	196,3 (403.9)	194,9 (399.5)	175,6 (387.3)	150,5 (332.0)	129,2 (285.0)	112,0 (247.0)	97,2 (214.3)
24,0 (80)	165,6 (359.1)	164,8 (357.3)	163,7 (354.8)	162,9 (353.2)	161,7 (350.5)	161,2 (349.3)	159,2 (344.9)	158,3 (342.0)	150,5 (332.0)	129,2 (285.0)	112,0 (247.0)	97,2 (214.3)
26,0 (90)	151,9 (316.1)	151,1 (314.4)	150,0 (312.0)	149,3 (310.3)	148,1 (307.7)	147,5 (306.4)	145,6 (302.1)	144,2 (299.2)	143,5 (297.5)	129,2 (285.0)	112,0 (247.0)	97,2 (214.3)
30,0 (100)	129,9 (281.5)	129,1 (279.8)	128,1 (277.5)	127,3 (275.9)	126,1 (273.2)	125,6 (272.0)	123,6 (267.6)	122,3 (264.8)	121,5 (263.0)	120,7 (260.2)	112,0 (247.0)	97,2 (214.3)
36,0 (120)	95,3 (200.5)	105,1 (227.6)	104,0 (225.3)	103,4 (223.8)	102,1 (221.1)	101,6 (219.9)	99,7 (215.6)	98,4 (212.8)	97,6 (211.1)	96,3 (208.2)	95,5 (206.4)	91,2 (198.2)
42,0 (140)		84,0 (175.1)	86,7 (187.7)	86,1 (186.3)	84,9 (183.6)	84,4 (182.5)	82,4 (178.2)	81,1 (175.4)	80,4 (173.7)	79,1 (170.9)	78,2 (169.0)	76,9 (166.1)
48,0 (160)			72,4 (152.2)	73,0 (157.9)	71,8 (155.3)	71,3 (154.1)	69,4 (150.0)	68,2 (147.2)	67,4 (145.5)	66,1 (142.7)	65,3 (140.8)	64,0 (138.0)
54,0 (180)				62,4 (133.2)	61,6 (133.0)	61,1 (132.0)	59,2 (127.8)	58,0 (125.1)	57,2 (123.4)	56,0 (120.6)	55,1 (118.8)	53,8 (116.0)
60,0 (200)						52,9 (114.1)	51,0 (110.0)	49,8 (107.3)	49,1 (105.7)	47,8 (102.9)	47,0 (101.1)	45,7 (98.3)
66,0 (220)							44,3 (95.4)	43,1 (92.7)	42,3 (91.1)	41,1 (88.3)	40,2 (86.5)	39,0 (83.7)
70,0 (240)							40,4 (83.0)	39,2 (80.4)	38,5 (78.8)	37,2 (76.1)	36,4 (74.1)	35,0 (70.6)
74,0 (260)							36,9 (—)	35,7 (69.9)	35,0 (68.2)	33,8 (64.8)	32,8 (62.6)	31,2 (59.2)
82,0 (280)								29,6 (—)	28,8 (58.2)	27,2 (54.9)	26,2 (52.8)	24,7 (49.3)
90,0 (300)										21,8 (46.2)	20,9 (44.1)	19,3 (40.7)
94,0 (320)										19,3 (—)	18,4 (36.4)	16,9 (33.1)
102,0 (340)												12,7 (26.3)
106,0 (360)												10,8 (—)

Meets ANSI B30.5 Requirements - Capacities do not exceed 75% of static tipping load.

NOTICE: This capacity chart is for reference only and must not be used for lifting purposes.

Long-reach boom range diagram

MAX-ÉR® 2000

No. 79-44 Long-Reach Boom

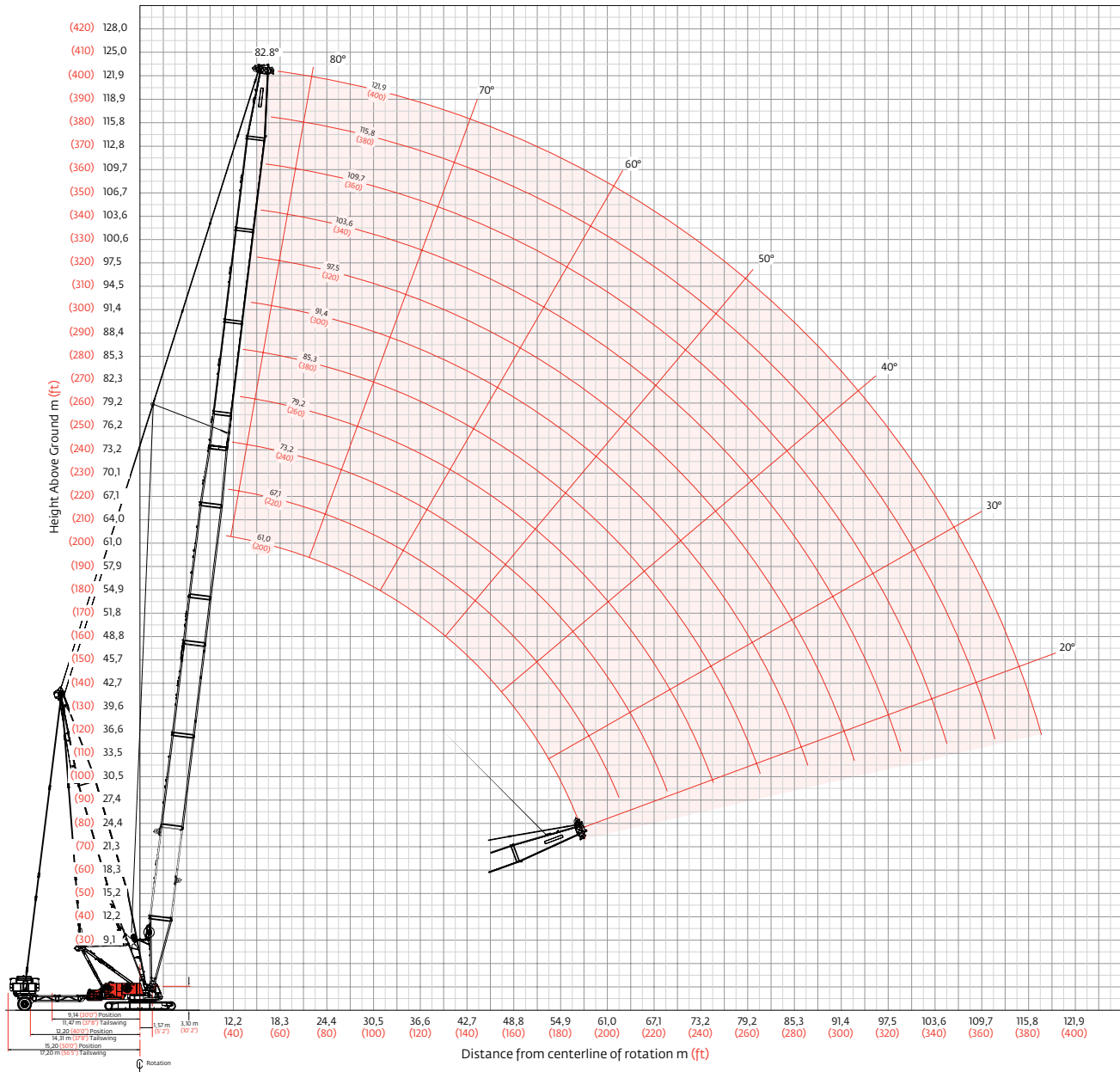

Long-reach boom load charts

MAX-ER® 2000

Liftcrane boom capacities - MAX-ER 2000 on 2250 Boom No. 79-44 with 39,6 m (130 ft) Mast No. 44												
Boom m (ft) Radius	76 750 kg (169,220 lb) Crane counterweight, 27 220 kg (60,000 lb) Carbody counterweight 209 560 kg (462,000 lb) Wheeled counterweight at 15,2 m (50 ft) position 360° Rating kg (lb) x 1 000											
	61,0 (200)	67,1 (220)	73,2 (240)	79,2 (260)	85,3 (280)	91,4 (300)	97,5 (320)	103,6 (340)	109,7 (360)	115,8 (380)	121,9 (400)	
11,6 (38)	272,1 (600.0)	257,5 (567.9)	233,7 (515.3)									
14,0 (50)	267,5 (545.8)	252,1 (543.7)	228,7 (500.3)	200,2 (437.3)	169,1 (370.3)	142,5 (313.3)	— (280.9)	— (241.0)				
18,0 (60)	208,5 (452.3)	207,6 (450.3)	207,8 (447.6)	194,2 (427.3)	158,5 (347.4)	141,2 (311.1)	125,7 (276.9)	108,9 (239.8)	92,1 (202.4)	79,9 (175.8)	— (148.0)	
20,0 (70)	186,8 (384.8)	185,9 (382.8)	184,6 (380.1)	184,9 (379.6)	151,8 (325.7)	140,2 (300.3)	124,5 (272.9)	108,2 (237.6)	90,2 (192.3)	78,7 (171.8)	64,0 (135.8)	
24,0 (80)	153,9 (333.6)	153,0 (331.7)	151,8 (329.0)	151,6 (328.6)	139,7 (305.7)	128,8 (281.9)	120,1 (262.0)	106,9 (235.4)	81,5 (178.1)	74,4 (162.3)	56,9 (124.1)	
26,0 (90)	141,1 (293.5)	140,2 (291.6)	139,0 (289.0)	138,8 (288.6)	134,0 (286.8)	123,7 (264.9)	114,8 (245.5)	105,7 (225.9)	77,5 (164.7)	70,5 (149.8)	53,5 (112.8)	
30,0 (100)	120,6 (261.3)	119,7 (259.4)	118,5 (256.8)	118,4 (256.4)	118,5 (256.5)	114,0 (248.9)	105,3 (229.8)	96,8 (211.4)	69,7 (151.9)	63,3 (137.9)	48,2 (106.8)	
32,0 (110)	112,2 (234.8)	111,4 (233.0)	110,1 (230.3)	110,0 (230.0)	110,1 (230.1)	109,4 (229.4)	100,8 (215.1)	92,8 (197.9)	66,0 (139.8)	59,9 (131.3)	48,2 (105.8)	
36,0 (120)	98,1 (212.6)	97,3 (210.8)	96,2 (208.2)	96,0 (207.8)	96,1 (208.0)	95,7 (207.3)	92,3 (201.0)	85,0 (185.2)	59,2 (128.8)	58,9 (129.7)	47,6 (104.8)	
38,0 (130)	92,2 (193.8)	91,4 (192.0)	90,2 (189.4)	90,1 (189.0)	90,1 (189.2)	89,9 (188.6)	87,9 (184.5)	81,4 (173.2)	57,9 (127.0)	58,4 (128.1)	47,3 (103.8)	
44,0 (150)	77,6 (163.5)	76,8 (161.7)	75,6 (159.1)	75,5 (158.8)	75,6 (159.0)	75,3 (158.4)	73,4 (154.3)	72,9 (153.7)	56,4 (123.4)	57,0 (124.9)	46,4 (101.8)	
50,0 (170)	66,4 (140.1)	65,6 (138.4)	64,5 (135.9)	64,3 (135.6)	64,4 (135.8)	64,2 (135.2)	62,3 (131.1)	62,0 (130.5)	54,8 (119.8)	55,6 (121.7)	45,5 (99.8)	
56,0 (190)	57,5 (121.5)	56,8 (119.9)	55,6 (117.4)	55,5 (117.1)	55,6 (117.4)	55,3 (116.8)	53,5 (112.6)	53,2 (112.1)	52,9 (112.0)	53,0 (111.3)	44,6 (97.8)	
64,0 (210)		47,5 (104.8)	46,4 (102.3)	46,3 (102.1)	46,4 (102.4)	46,1 (101.8)	44,3 (97.7)	44,0 (97.2)	44,0 (97.1)	43,6 (96.3)	43,4 (95.8)	
68,0 (230)			42,5 (89.7)	42,4 (89.6)	42,6 (89.9)	42,3 (89.4)	40,4 (85.2)	40,2 (84.7)	40,2 (84.7)	39,9 (83.9)	39,7 (83.7)	
76,0 (250)				35,9 (78.9)	36,1 (79.3)	35,8 (78.8)	34,0 (74.7)	33,8 (74.3)	33,8 (74.2)	33,4 (73.5)	33,3 (73.3)	
80,0 (270)					33,1 (66.3)	33,1 (67.6)	31,2 (65.7)	31,0 (65.3)	31,0 (65.3)	30,7 (64.6)	30,6 (64.3)	
88,0 (290)						23,7 (51.2)	26,4 (57.8)	26,2 (57.5)	26,3 (57.5)	25,9 (56.8)	25,8 (56.6)	
92,0 (310)							24,3 (50.9)	24,2 (50.6)	24,2 (50.7)	23,8 (50.0)	23,8 (49.8)	
100,0 (330)								20,2 (43.5)	20,5 (44.7)	20,2 (44.0)	20,1 (43.9)	
104,0 (350)									17,6 (33.7)	18,0 (35.1)	18,4 (36.6)	
112,0 (370)										12,0 (25.2)	12,9 (27.4)	
116,0 (390)											10,3 (18.6)	

Meets ANSI B30.5 Requirements - Capacities do not exceed 75% of static tipping load.

NOTICE: This capacity chart is for reference only and must not be used for lifting purposes.

Fixed jib range diagram

MAX-ER® 2000

No. 132 Fixed jib on No. 79-44 Long-reach boom

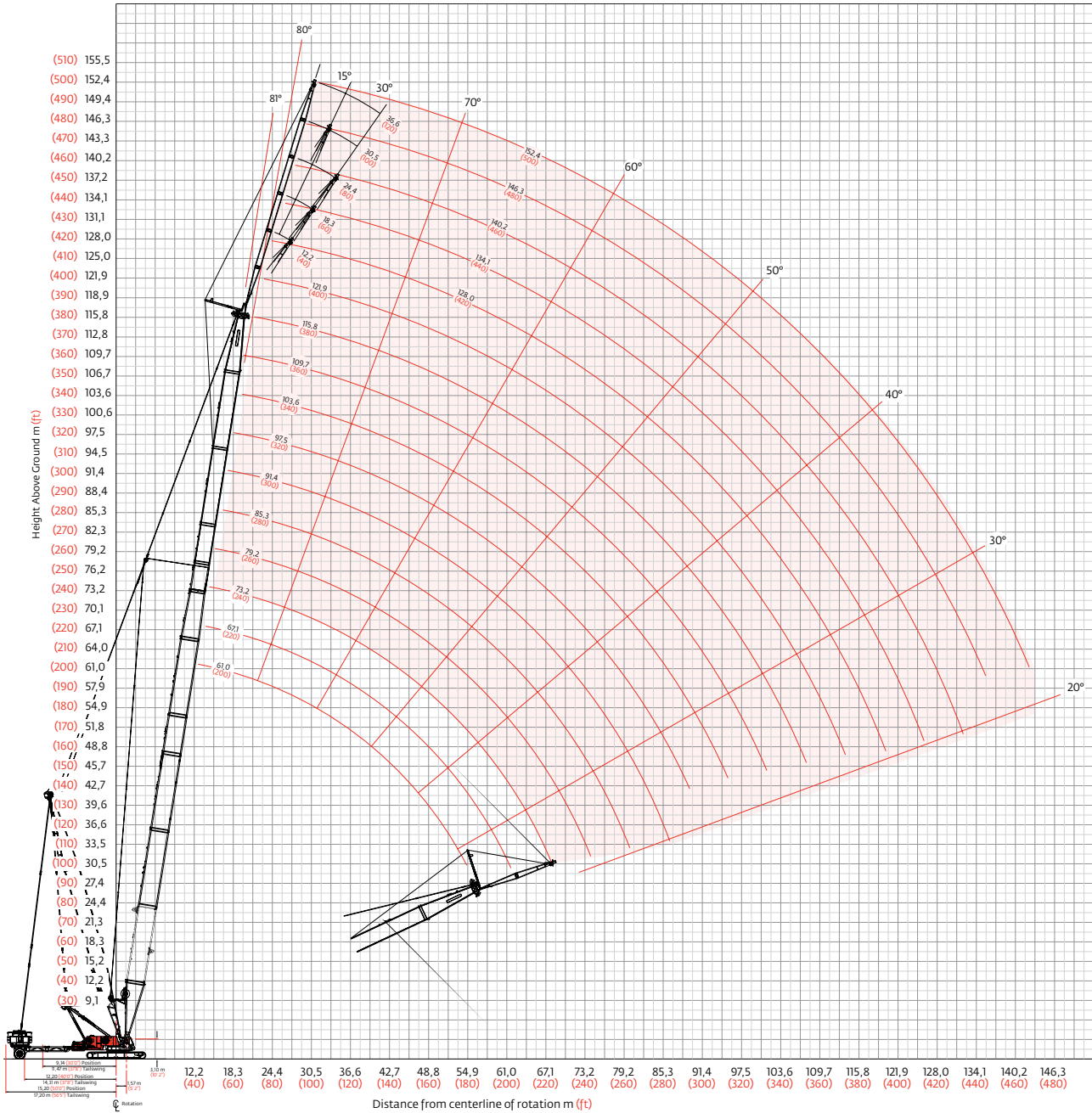

Fixed jib load charts

MAX-ER® 2000

Liftcrane jib capacities - MAX-ER 2000 on 2250
 Jib No. 132 with 6 096 mm (20 ft) strut on
 Boom No. 79-44 with 39,6 m (130 ft) Mast No. 44

76 750 kg (169,200 lb) Crane counterweight, 27 220 kg (60,000 lb) Carbody counterweight
 209 560 kg (462,000 lb) Wheeled counterweight at 15,2 m (50 ft) position
 360° Rating kg (lb) x 1 000

Boom m (ft) Radius	5° Offset				
	61,0 (200)	79,2 (260)	91,4 (300)	103,6 (340)	115,8 (380)
15,2 (50)	45,3 (100.0)				
18,0 (60)	43,3 (94.8)	— (98.5)			
24,0 (80)	38,0 (83.3)	41,3 (90.5)	41,2 (90.4)	37,6 (83.1)	— (83.1)
32,0 (110)	32,9 (70.9)	36,3 (78.4)	36,8 (79.8)	37,6 (82.4)	37,6 (83.1)
42,0 (140)	28,4 (62.2)	31,7 (69.5)	32,7 (71.6)	34,0 (74.5)	35,1 (77.0)
50,0 (170)	25,8 (55.9)	28,9 (62.6)	30,0 (65.2)	31,4 (68.2)	32,5 (70.6)
66,0 (220)	22,4 (49.2)	24,9 (54.5)	26,1 (57.2)	27,3 (59.9)	28,5 (62.3)
82,0 (270)		15,3 (32.9)	23,4 (51.7)	24,5 (54.0)	25,5 (56.2)
94,0 (320)			22,2 (48.5)	23,0 (48.6)	23,7 (48.3)
110,0 (370)				13,5 (—)	13,3 (25.7)
122,0 (410)					

Boom m (ft) Radius	30° Offset				
	61,0 (200)	79,2 (260)	91,4 (300)	103,6 (340)	115,8 (380)
20,0 (65)	22,9 (50.7)				
24,0 (80)	21,3 (46.7)	22,6 (49.7)	— (55.4)		
30,0 (100)	19,3 (42.4)	20,8 (45.6)	25,1 (55.4)	25,1 (55.4)	25,1 (55.4)
36,0 (120)	17,7 (38.9)	19,3 (42.3)	24,0 (52.7)	24,8 (54.5)	25,1 (55.4)
42,0 (140)	16,5 (36.2)	18,0 (39.5)	22,5 (49.5)	23,4 (51.4)	24,2 (53.1)
50,0 (170)	15,1 (33.0)	16,6 (36.2)	20,9 (45.5)	21,8 (47.5)	22,6 (49.2)
58,0 (200)		15,5 (33.6)	19,6 (42.3)	20,4 (44.2)	21,3 (46.0)
70,0 (230)			11,9 (26.2)	18,0 (39.8)	19,6 (43.3)
78,0 (260)				17,2 (37.9)	18,0 (39.5)
90,0 (300)					17,6 (38.7)
98,0 (330)					

Boom m (ft) Radius	5° Offset				
	61,0 (200)	79,2 (260)	91,4 (300)	103,6 (340)	115,8 (380)
15,2 (50)					
18,0 (60)	34,2 (75.2)				
24,0 (80)	32,3 (71.1)	32,7 (72.1)	32,0 (70.4)	— (69.9)	
32,0 (110)	30,3 (66.0)	31,0 (67.8)	30,6 (67.0)	30,5 (66.8)	29,8 (65.5)
42,0 (140)	28,2 (62.0)	29,1 (64.1)	29,1 (64.0)	29,2 (64.2)	28,7 (63.2)
50,0 (170)	24,5 (52.3)	27,9 (61.2)	28,0 (61.4)	28,2 (61.8)	27,9 (61.2)
66,0 (220)	18,7 (40.7)	22,7 (49.3)	26,3 (57.9)	26,6 (58.6)	26,5 (58.3)
82,0 (270)		14,8 (32.0)	21,8 (48.1)	23,9 (52.7)	25,4 (56.0)
94,0 (320)			19,3 (41.3)	21,1 (45.1)	23,0 (49.0)
110,0 (370)				16,2 (32.2)	15,8 (31.2)
122,0 (410)					8,9 (16.2)

Boom m (ft) Radius	30° Offset				
	61,0 (200)	79,2 (260)	91,4 (300)	103,6 (340)	115,8 (380)
20,0 (65)					
24,0 (80)	— (33.8)				
30,0 (100)	14,0 (30.7)	14,8 (32.6)	18,8 (41.3)	— (42.3)	
36,0 (120)	12,8 (28.2)	13,8 (30.2)	17,6 (38.6)	18,1 (39.7)	18,5 (40.7)
42,0 (140)	11,9 (26.2)	12,8 (28.2)	16,5 (36.3)	17,1 (37.5)	17,6 (38.6)
50,0 (170)	10,9 (23.8)	11,9 (25.8)	15,4 (33.4)	15,9 (34.7)	16,4 (35.8)
58,0 (200)		10,1 (22.0)	11,1 (23.9)	14,4 (31.1)	15,0 (32.4)
70,0 (230)			10,2 (22.5)	13,2 (29.2)	14,3 (31.6)
78,0 (260)				12,6 (27.8)	13,1 (28.9)
90,0 (300)					12,4 (27.3)
98,0 (330)					12,4 (27.2)

Meets ANSI B30.5 Requirements - Capacities do not exceed 75% of static tipping load.

NOTICE: This capacity chart is for reference only and must not be used for lifting purposes.

Fixed jib load charts

MAX-ER® 2000

Liftcrane jib capacities - MAX-ER 2000 on 2250
 Jib No. 132 with 6 096 mm (20 ft) strut on
 Boom No. 79-44 with 39,6 m (130 ft) Mast No. 44

76 750 kg (169,200 lb) Crane counterweight, 27 220 kg (60,000 lb) Carbody counterweight
 209 560 kg (462,000 lb) Wheeled counterweight at 15,2 m (50 ft) position
 360° Rating kg (lb) x 1 000

Boom m (ft) Radius	5° Offset					30° Offset				
	61,0 (200)	79,2 (260)	91,4 (300)	103,6 (340)	115,8 (380)	61,0 (200)	79,2 (260)	91,4 (300)	103,6 (340)	115,8 (380)
20,0 (65)	20,7 (45.8)					9,4 (20.8)				
26,0 (90)	19,3 (42.0)	19,7 (42.9)	119,2 (42.0)			8,8 (19.4)	9,3 (20.4)	—		
38,0 (125)	16,8 (37.2)	17,7 (39.0)	17,5 (38.7)	17,7 (39.0)	17,5 (38.6)	8,1 (17.7)	8,6 (18.9)	11,5 (25.2)	11,8 (25.9)	12,1 (26.5)
44,0 (150)	15,6 (33.9)	16,7 (36.4)	16,7 (36.5)	16,9 (37.1)	16,9 (36.9)	7,2 (15.7)	7,8 (17.0)	10,6 (23.0)	10,9 (23.7)	11,2 (24.4)
58,0 (200)	13,3 (28.4)	14,6 (31.3)	14,9 (32.2)	15,4 (33.3)	15,5 (33.8)	6,6 (14.1)	7,2 (15.4)	9,8 (21.1)	10,1 (21.9)	10,5 (22.6)
74,0 (250)	10,8 (23.1)	12,5 (27.2)	13,1 (28.4)	13,7 (29.7)	14,0 (30.6)	5,8 (12.6)	6,4 (13.8)	8,8 (19.1)	9,2 (19.9)	9,5 (20.7)
90,0 (300)		9,2 (18.9)	11,6 (25.3)	12,2 (26.7)	12,6 (27.7)		5,8 (10.8)	8,1 (17.6)	8,4 (18.4)	8,8 (19.1)
106,0 (350)			10,4 (23.0)	11,0 (24.2)	11,5 (25.3)			7,5 (16.7)	7,9 (17.4)	8,2 (18.1)
122,0 (400)				10,2 (22.5)	10,5 (23.3)				7,6 (16.7)	7,9 (17.3)
134,0 (440)					6,9 (15.3)					7,6 (16.6)
142,0 (470)										

Boom m (ft) Radius	5° Offset					30° Offset				
	61,0 (200)	79,2 (260)	91,4 (300)	103,6 (340)	115,8 (380)	61,0 (200)	79,2 (260)	91,4 (300)	103,6 (340)	115,8 (380)
20,0 (65)										
26,0 (90)	15,6 (33.9)	16,1 (35.0)	15,7 (34.3)			8,0 (17.5)				
38,0 (125)	12,9 (28.4)	13,8 (30.5)	13,8 (30.5)	14,1 (31.2)	14,1 (31.2)	7,2 (15.9)	7,7 (16.9)	8,6 (19.0)	8,7 (19.3)	
44,0 (150)	11,7 (25.1)	12,8 (27.6)	12,9 (27.9)	13,3 (28.8)	13,4 (29.3)	6,4 (13.9)	6,9 (15.0)	8,0 (17.5)	8,2 (17.9)	8,3 (18.2)
58,0 (200)	9,4 (19.8)	10,6 (22.6)	10,9 (23.4)	11,5 (24.6)	11,8 (25.4)	5,7 (12.3)	6,2 (13.5)	7,5 (16.1)	7,7 (16.6)	7,8 (17.1)
74,0 (250)	7,4 (15.9)	8,7 (18.9)	9,1 (19.9)	9,7 (21.1)	10,2 (22.0)	5,0 (10.7)	5,5 (11.9)	6,8 (14.7)	7,0 (15.2)	7,2 (15.7)
90,0 (300)	6,0 (13.2)	7,2 (15.6)	7,7 (16.8)	8,3 (18.1)	8,7 (19.2)		4,9 (10.6)	6,2 (13.5)	6,5 (14.0)	6,7 (14.5)
106,0 (350)		2,8 (5.8)	6,6 (14.5)	7,1 (15.9)	7,6 (16.8)		3,0 (6.3)	5,8 (12.8)	6,0 (13.3)	6,2 (13.8)
122,0 (400)			— (12.8)	6,2 (13.8)	6,7 (14.8)			5,6 (12.3)	5,8 (12.7)	5,9 (13.2)
134,0 (440)				5,7 (12.9)	6,1 (13.5)				5,6 (12.3)	5,7 (12.6)
142,0 (470)					5,2 (10.5)					5,6 (12.4)

Meets ANSI B30.5 Requirements - Capacities do not exceed 75% of static tipping load.

NOTICE: This capacity chart is for reference only and must not be used for lifting purposes.

Luffing jib range diagram

MAX-ER® 2000

No. 44 Luffing jib on No. 79 Boom

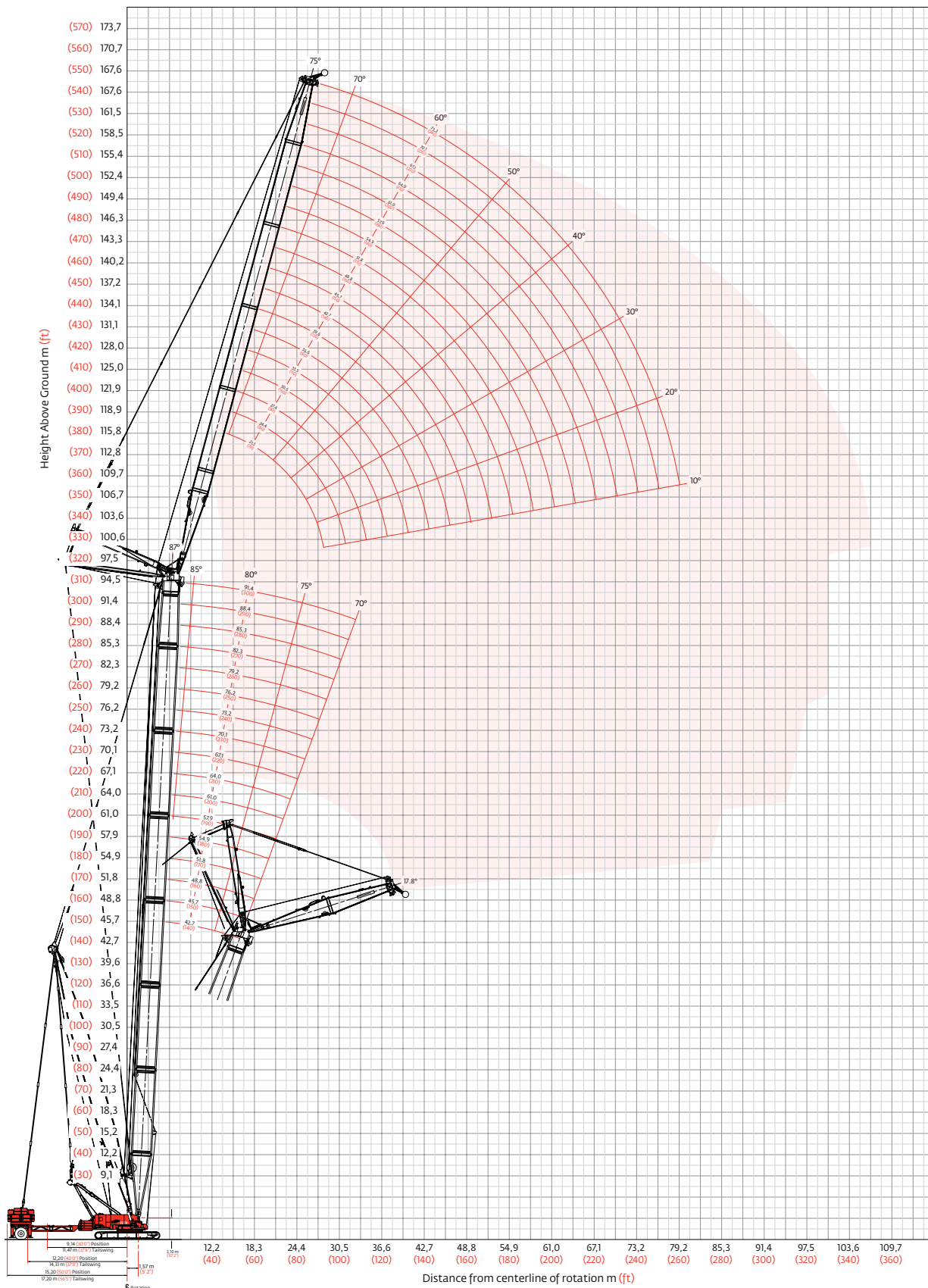

Luffing jib load charts

MAX-ER® 2000

Liftcrane luffing jib capacities - MAX-ER 2000 on 2250

Luffing jib No. 44 on

Boom No. 79 with 39,6 m (130 ft) Mast No. 44

76 750 kg (169,200 lb) Crane counterweight, 27 220 kg (60,000 lb) Carbody counterweight
209 560 kg (462,000 lb) Wheeled counterweight at 15,2 m (50 ft) position
360° Rating kg (lb) x1000

85° Angle for boom less than 61,0 m (200') and

87° Angle for boom 61,0 m (200') or longer

Boom m (ft) Radius	42,7 (140)	54,9 (180)	67,1 (220)	79,2 (260)	91,4 (300)	Boom m (ft) Radius	42,7 (140)	54,9 (180)	67,1 (220)	79,2 (260)	91,4 (300)
	Luffing jib length 21,3 m (70 ft)										
13,7 (45)	226,7 (500.0)		144,6 (319.0)			13,7 (45)					
16,0 (55)	184,3 (402.9)	170,1 (367.5)	140,6 (304.2)	103,8 (228.4)	76,2 (167.9)	16,0 (55)					
18,0 (65)	175,4 (340.8)	161,2 (338.6)	134,3 (284.8)	103,0 (225.0)	75,8 (166.1)	18,0 (65)	— (303.8)		— (206.2)	— (163.1)	— (123.0)
24,0 (80)	114,3 (246.0)	123,0 (264.1)	112,5 (242.8)	93,0 (203.3)	73,9 (162.5)	24,0 (80)	122,2 (263.9)	115,4 (252.6)	85,8 (187.7)	68,9 (150.9)	54,6 (120.0)
28,0 (95)						28,0 (95)	102,9 (212.8)	106,4 (228.7)	77,9 (167.6)	63,4 (137.0)	51,0 (110.6)
32,0 (105)						32,0 (105)	81,3 (179.3)	87,1 (192.2)	70,1 (154.6)	57,9 (127.8)	47,2 (104.2)
34,0 (115)						34,0 (115)	72,9 (152.0)	78,1 (162.9)	66,5 (142.5)	55,3 (119.2)	45,4 (98.1)
38,0 (130)						38,0 (130)	63,0 (128.0)	67,7 (137.9)	60,0 (127.3)	50,6 (108.0)	41,9 (89.9)
42,0 (140)						42,0 (140)	50,3 (106.1)	54,6 (115.7)	51,4 (112.6)	46,8 (102.3)	39,2 (85.6)
44,0 (150)						44,0 (150)	45,9 (84.5)	48,1 (99.0)	46,3 (—)	45,6 (92.2)	38,2 (83.3)

Boom m (ft) Radius	42,7 (140)	54,9 (180)	67,1 (220)	79,2 (260)	91,4 (300)	Boom m (ft) Radius	42,7 (140)	54,9 (180)	67,1 (220)	79,2 (260)	91,4 (300)
	Luffing jib length 57,9 m (190 ft)										
24,0 (80)	— (189.6)		61,1 (134.3)	49,6 (109.0)	— (87.2)	24,0 (80)					
26,0 (90)	84,1 (182.0)	77,7 (168.9)	59,6 (128.9)	48,5 (105.1)	38,8 (84.3)	26,0 (90)			44,7 (97.5)	— (79.9)	— (63.6)
30,0 (100)	79,6 (174.4)	74,2 (162.6)	56,1 (122.9)	45,9 (100.6)	36,9 (81.0)	30,0 (100)	61,5 (134.7)	— (120.5)	43,1 (94.6)	35,3 (77.6)	28,2 (62.0)
36,0 (120)	67,0 (146.8)	67,4 (147.1)	50,3 (109.8)	41,6 (90.8)	33,7 (73.8)	36,0 (120)	55,3 (120.7)	52,0 (114.1)	40,1 (87.7)	33,0 (72.2)	26,4 (57.9)
42,0 (140)	54,4 (116.8)	57,5 (123.2)	44,4 (96.6)	37,1 (80.8)	30,4 (66.4)	42,0 (140)	49,2 (107.1)	48,4 (105.7)	36,6 (80.0)	30,2 (66.1)	24,3 (53.2)
50,0 (170)	38,9 (83.2)	41,2 (88.2)	37,4 (79.4)	31,7 (67.6)	26,3 (56.3)	50,0 (170)	41,0 (84.4)	41,6 (88.4)	31,9 (68.1)	26,5 (56.7)	21,4 (46.0)
60,0 (200)	27,1 (59.9)	28,8 (60.3)	28,8 (59.7)	26,8 (58.6)	22,6 (49.4)	60,0 (200)	28,1 (59.8)	29,7 (63.1)	26,4 (57.4)	22,2 (48.2)	18,1 (39.3)
70,0 (230)						70,0 (230)	20,6 (45.4)	22,1 (48.6)	20,7 (45.4)	18,8 (41.4)	15,4 (34.1)
74,0 (245)						74,0 (245)	16,7 (35.5)	18,3 (38.9)	18,1 (39.3)	17,8 (39.1)	14,7 (32.3)
78,0 (260)						78,0 (260)	13,8 (25.1)	15,7 (31.0)		14,8 (28.4)	14,3 (31.3)

Meets ANSI B30.5 Requirements - Capacities do not exceed 75% of static tipping load.

NOTICE: This capacity chart is for reference only and must not be used for lifting purposes.

Luffing jib load charts

MAX-ER® 2000

Liftcrane luffing jib capacities - MAX-ER 2000 on 2250

Luffing jib No. 44 on

Boom No. 79 with 39,6 m (130 ft) Mast No. 44

76 750 kg (169,200 lb) Crane counterweight, 27 220 kg (60,000 lb) Carbody counterweight

209 560 kg (462,000 lb) Wheeled counterweight at 15,2 m (50') position

360° Rating kg (lb) x 1 000

80° Boom angle

Boom m (ft) Radius	42,7	54,9	7,1	79,2	91,4
	(140)	(180)	(220)	(260)	(300)
Luffing jib length 21,3 m (70 ft)	20,0 (65)	186,5 (414.9)			
	22,0 (75)	169,1 (358.6)	165,6 (350.8)		
	26,0 (90)	129,4 (259.0)	139,3 (290.4)	136,0 (283.6)	108,1 (237.6)
	30,0 (100)	99,0 (210.7)	114,7 (244.5)	117,0 (253.7)	106,5 (234.4)
	36,0 (120)			93,3 (202.2)	76,5 (168.4)
	42,0 (140)				
	48,0 (160)				
	50,0 (170)				
	54,0 (180)				
	56,0 (190)				

Boom m (ft) Radius	42,7	54,9	67,1	79,2	91,4
	(140)	(180)	(220)	(260)	(300)
Luffing jib length 39,6 m (130 ft)	20,0 (65)				
	22,0 (75)				
	26,0 (90)	133,6 (281.8)			
	30,0 (100)	108,1 (231.6)	116,7 (255.1)	—	(226.0)
	36,0 (120)	82,3 (176.1)	94,0 (199.3)	94,5 (205.7)	76,5 (167.2)
	42,0 (140)	62,0 (138.0)	67,9 (144.6)	76,2 (162.2)	68,9 (150.1)
	48,0 (160)	45,9 (98.8)	52,9 (111.2)	60,2 (127.3)	60,7 (131.8)
	50,0 (170)		48,4 (87.8)	53,7 (105.2)	58,2 (121.6)
	54,0 (180)				51,5 (105.4)
	56,0 (190)				45,1 (98.3)
					43,8 (95.0)

Boom m (ft) Radius	42,7	54,9	67,1	79,2	91,4
	(140)	(180)	(220)	(260)	(300)
Luffing jib length 57,9 m (190 ft)	24,0 (80)				
	26,0 (90)				
	30,0 (100)				
	36,0 (120)	77,7 (170.3)	75,5 (165.5)		
	44,0 (150)	57,5 (123.4)	61,4 (130.9)	62,3 (134.5)	51,1 (110.7)
	54,0 (180)	39,9 (85.0)	43,9 (93.7)	48,1 (102.5)	44,6 (97.1)
	64,0 (210)	27,7 (61.1)	31,5 (69.5)	35,0 (77.2)	37,3 (82.3)
	72,0 (240)			28,2 (57.3)	27,4 (59.7)
	82,0 (270)				
	90,0 (300)				

Boom m (ft) Radius	42,7	54,9	67,1	79,2	91,4
	(140)	(180)	(220)	(260)	(300)
Luffing jib length 73,2 m (240 ft)	24,0 (80)				
	26,0 (90)				
	30,0 (100)				
	36,0 (120)				
	44,0 (150)	51,3 (109.7)	51,2 (109.9)	47,0 (102.9)	—
	54,0 (180)	40,7 (89.0)	42,3 (93.1)	43,1 (93.7)	36,1 (79.1)
	64,0 (210)	28,9 (63.8)	31,6 (69.7)	34,3 (75.7)	32,0 (70.6)
	72,0 (240)	22,5 (49.5)	25,0 (54.9)	25,8 (57.0)	28,0 (61.2)
	82,0 (270)	14,2 (31.4)	16,2 (35.0)	18,6 (40.4)	20,8 (45.3)
	90,0 (300)				16,5 (31.0)

Meets ANSI B30.5 Requirements - Capacities do not exceed 75% of static tipping load.

NOTICE: This capacity chart is for reference only and must not be used for lifting purposes.

Luffing jib load charts

MAX-ER® 2000

Liftcrane luffing jib capacities - MAX-ER 2000 on 2250
Luffing jib No. 44 on
Boom No. 79 with 39,6 m (130 Ft) Mast No. 44

76 750 kg (169,200 lb) Crane counterweight, 27 220 kg (60,000 lb) Carbody counterweight
209 560 kg (462,000 lb) Wheeled counterweight at 15,2 m (50') position
360° Rating kg (lb) x 1 000

70° Boom angle

Luffing jib length 21,3 m (70 ft)	Boom m (ft) Radius	42,7 (140)	54,9 (180)	67,1 (220)	79,2 (260)	91,4 (300)
	30,0 (100)	—	(252.0)			
32,0 (110)	108,5	(227.6)				
36,0 (120)	95,4	(206.8)	91,4 (198.2)			
38,0 (130)	89,8	—	86,2 (181.3)	— (172.5)		
44,0 (150)				69,4 (146.4)	65,4 (138.0)	
50,0 (170)					56,2 —	52,3 (110.6)
56,0 (190)						
64,0 (210)						
70,0 (230)						
72,0 (240)						

Luffing jib length 39,6 m (130 ft)	Boom m (ft) Radius	42,7 (140)	54,9 (180)	67,1 (220)	79,2 (260)	91,4 (300)
	30,0 (100)					
32,0 (110)						
36,0 (120)						
38,0 (130)		— (186.5)				
44,0 (150)		75,3 (156.0)	— (151.2)			
50,0 (170)		61,4 (123.1)	61,9 (131.0)	58,3 (123.5)	— (115.0)	
56,0 (190)		46,7 —	54,2 (114.8)	51,1 (108.2)	47,5 (100.7)	— (92.4)
64,0 (210)				43,2 (95.4)	40,3 (89.0)	36,9 (81.5)
70,0 (230)						32,8 (72.3)
72,0 (240)						31,6 (68.0)

Luffing jib length 57,9 m (190 ft)	Boom m (ft) Radius	42,7 (140)	54,9 (180)	67,1 (220)	79,2 (260)	91,4 (300)
	50,0 (165)	—	(132.9)			
52,0 (175)	56,2	(117.5)	— (122.2)			
56,0 (185)	47,9	(104.2)	52,3 (114.4)			
60,0 (200)	43,4	(94.6)	48,0 (103.2)	44,9 (97.2)		
66,0 (220)	35,1	(74.2)	41,9 (88.6)	39,9 (86.3)	36,7 (79.4)	— (71.7)
76,0 (250)			29,8 (65.6)	33,1 (72.9)	30,4 (66.9)	27,4 (60.3)
84,0 (280)					26,4 (56.8)	23,7 (51.1)
94,0 (310)						
98,0 (330)						
106,0 (350)						

Luffing jib length 73,2 m (240 ft)	Boom m (ft) Radius	42,7 (140)	54,9 (180)	67,1 (220)	79,2 (260)	91,4 (300)
	50,0 (165)					
52,0 (175)						
56,0 (185)						
60,0 (200)		41,8 (89.1)				
66,0 (220)		33,8 (71.8)	39,4 (83.7)	38,0 (82.2)		
76,0 (250)		26,0 (57.0)	30,3 (66.8)	31,4 (69.2)	28,6 (62.8)	25,4 (55.9)
84,0 (280)		18,8 (41.0)	22,7 (47.6)	26,8 (56.3)	24,7 (53.3)	21,8 (47.0)
94,0 (310)			15,9 (34.8)	20,2 (43.2)	20,7 (45.4)	17,7 (38.8)
98,0 (330)					19,3 (39.1)	16,2 (33.9)
106,0 (350)						13,5 (29.2)

Meets ANSI B30.5 Requirements - Capacities do not exceed 75% of static tipping load.

NOTICE: This capacity chart is for reference only and must not be used for lifting purposes.

Luffing jib load charts

MAX-ER® 2000

Liftcrane luffing jib capacities - MAX-ER 2000 on 2250
Luffing jib No. 133A or No. 133 on
Boom No. 79-44 with 39,6 m (130 ft) Mast No. 44

76 750 kg (169,200 lb) Crane counterweight, 27 220 kg (60,000 lb) Carbody counterweight
209 560 kg (462,000 lb) Wheeled counterweight at 15,2 m (50') position
360° Rating kg (lb) x1 000

85° Angle for boom less than 67,1 m (220') and
87° Angle for boom 67,1 m (220') or longer

Boom m (ft) Radius	61,0 (200)	67,1 (220)	73,2 (240)	85,3 (280)	91,4 (300)	Boom m (ft) Radius	61,0 (200)	67,1 (220)	73,2 (240)	85,3 (280)	91,4 (300)												
	Luffing jib length 21,3 m (70 ft)						Luffing jib length 36,6 m (120 ft)																
15,2 (50)													87,5 (193.0)	— (167.5)	78,7 (173.7)	71,8 (158.5)	61,0 (134.6)	15,2 (50)					
18,0 (60)													69,2 (147.1)	57,6 (124.1)	59,3 (127.6)	63,7 (136.0)	61,0 (134.6)	18,0 (60)		50,9 (111.6)	50,5 (110.6)	48,0 (105.2)	42,5 (93.7)
20,0 (70)													56,8 (122.2)	48,9 (97.8)	50,1 (100.1)	53,0 (105.3)	55,0 (108.6)	20,0 (70)	51,7 (110.3)	48,4 (102.2)	48,1 (102.8)	46,1 (98.8)	42,4 (93.5)
24,0 (80)													41,8 (90.0)	37,2 (80.2)	37,9 (81.7)	39,6 (85.4)	40,6 (87.5)	24,0 (80)	43,9 (93.8)	38,6 (83.1)	39,4 (84.8)	41,1 (88.4)	40,1 (87.9)
26,0 (90)													— (74.6)			— (71.2)	— (72.8)	26,0 (90)	38,2 (77.2)	34,1 (69.5)	34,8 (70.8)	36,2 (73.4)	36,9 (74.7)
30,0 (100)																		30,0 (100)	30,2 (65.1)	27,5 (59.3)	28,0 (60.3)	28,9 (62.2)	29,4 (63.3)
32,0 (110)																		32,0 (110)	27,3 (55.9)	24,9 (51.4)	25,4 (52.1)	26,1 (53.7)	26,5 (54.5)
36,0 (120)																		36,0 (120)	22,6 (48.7)	20,9 (45.0)	21,1 (45.6)	21,8 (46.9)	22,0 (47.5)
38,0 (130)																		38,0 (130)	20,7 (42.8)	19,2 (39.8)	19,4 (40.3)	20,0 (41.3)	20,2 (41.9)
42,0 (140)						42,0 (140)	17,6 (37.9)			17,0 (36.7)	17,2 (37.1)												

Boom m (ft) Radius	61,0 (200)	67,1 (220)	73,2 (240)	85,3 (280)	91,4 (300)	Boom m (ft) Radius	61,0 (200)	67,1 (220)	73,2 (240)	85,3 (280)	91,4 (300)												
	Luffing jib length 48,8 m (160 ft)						Luffing jib length 61,0 m (200 ft)																
— (85)													— (77.7)	— (73.4)	— (73.0)	— (70.1)	— (65.9)	— (85)	— (56.8)	— (54.3)	— (53.9)	— (50.0)	— (48.1)
28,0 (95)													33,4 (71.0)	30,8 (64.1)	31,3 (65.3)	30,6 (66.4)	28,8 (62.6)	28,0 (95)	24,8 (53.1)	23,1 (49.7)	23,2 (49.7)	22,3 (48.7)	21,5 (47.1)
32,0 (110)													27,2 (55.7)	24,9 (51.0)	25,2 (51.8)	26,0 (53.4)	26,5 (54.2)	32,0 (110)	21,9 (46.0)	20,4 (42.9)	20,5 (43.1)	20,3 (42.9)	20,1 (42.6)
38,0 (125)													20,5 (45.1)	18,9 (41.6)	19,2 (42.2)	19,7 (43.4)	20,0 (44.0)	38,0 (125)	17,8 (39.3)	16,6 (36.6)	16,7 (36.8)	16,8 (37.1)	16,8 (37.1)
42,0 (140)													17,3 (37.2)	16,1 (34.6)	16,3 (35.1)	16,7 (36.0)	16,9 (36.4)	42,0 (140)	15,4 (33.3)	14,3 (30.9)	14,5 (31.3)	14,7 (31.7)	14,8 (31.9)
46,0 (155)													14,8 (31.2)	13,8 (29.2)	14,0 (29.5)	14,3 (30.2)	14,5 (30.6)	46,0 (155)	13,3 (28.0)	12,3 (26.0)	12,5 (26.3)	12,7 (26.9)	12,8 (27.1)
50,0 (170)													12,8 (26.5)	11,9 (24.8)	12,1 (25.1)	12,4 (25.7)	12,5 (26.0)	50,0 (170)	11,4 (23.4)	10,5 (21.7)	10,6 (22.0)	10,9 (22.5)	11,0 (22.8)
56,0 (185)																		56,0 (185)	8,9 (19.4)	8,2 (17.9)	8,3 (18.2)	8,6 (18.7)	8,7 (19.0)
60,0 (200)																		60,0 (200)	7,5 (15.9)	6,9 (14.6)	7,0 (14.9)	7,2 (15.4)	7,3 (15.6)
64,0 (210)						64,0 (210)	6,3 (13.9)	5,7 (12.7)	5,8 (12.9)	6,0 (13.4)	6,1 (13.6)												
66,0 (220)						66,0 (220)	5,7 (12.1)			5,5 (11.8)	5,6 (11.9)												

Meets ANSI B30.5 Requirements - Capacities do not exceed 75% of static tipping load.

NOTICE: This capacity chart is for reference only and must not be used for lifting purposes.

Luffing jib load charts

MAX-ER® 2000

Liftcrane luffing jib capacities - MAX-ER 2000 on 2250

Luffing jib No. 133A or No. 133 on

Boom No. 79-44 with 39,6 m (130 ft) Mast No. 44

76 750 kg (169,200 lb) Crane counterweight, 27 220 kg (60,000 lb) Carbody counterweight
209 560 kg (462,000 lb) Wheeled counterweight at 15,2 m (50') position
360° Rating kg (lb) x 1 000

80° Boom angle

Boom m (ft) Radius	61,0	67,1	73,2	85,3	91,4
	(200)	(220)	(240)	(280)	(300)
Luffing jib length 21,3 m (70 ft)	20,0 (70)	— (190.1)			
24,0 (80)	64,1 (136.6)	71,9 (151.5)	— (170.0)		
26,0 (90)	53,6 (105.7)	58,8 (114.8)	64,9 (125.5)	61,2 (129.4)	— (122.3)
30,0 (100)	40,0 (85.6)	42,9 (91.8)	46,3 (98.7)	54,0 (116.6)	51,6 (112.2)
34,0 (115)		33,4 (69.6)	35,6 (73.9)	40,8 (84.1)	44,3 (90.5)
38,0 (130)				32,0 —	34,2 —
44,0 (145)					
48,0 (160)					
50,0 (170)					

Boom m (ft) Radius	61,0	67,1	73,2	85,3	91,4
	(200)	(220)	(240)	(280)	(300)
Luffing jib length 36,6 m (120 ft)	20,0 (70)				
24,0 (80)					
26,0 (90)	— (108.9)				
30,0 (100)	41,8 (89.1)	44,9 (95.7)	47,4 (103.3)		
34,0 (115)	32,5 (67.8)	34,6 (71.9)	36,9 (76.4)	40,5 (87.1)	38,3 (82.6)
38,0 (130)	26,4 (54.0)	27,8 (56.7)	29,4 (59.7)	33,0 (66.6)	35,0 (70.6)
44,0 (145)	20,2 (44.2)	21,1 (46.2)	22,0 (48.3)	24,3 (53.1)	25,5 (55.8)
48,0 (160)	17,2 (36.9)	17,9 (38.4)	18,6 (40.0)	20,3 (43.6)	21,3 (45.5)
50,0 (170)		16,6 —	17,2 —	18,8 (38.6)	19,6 (40.2)

Boom m (ft) Radius	61,0	67,1	73,2	85,3	91,4
	(200)	(220)	(240)	(280)	(300)
Luffing jib length 48,8 m (160 ft)	34,0 (115)	33,0 (68.0)	33,6 (72.3)	33,9 (73.5)	
38,0 (125)	26,3 (57.9)	27,8 (61.1)	29,5 (64.6)	31,2 (68.7)	29,7 (65.5)
42,0 (140)	21,7 (46.6)	22,8 (48.9)	24,0 (51.3)	26,6 (56.9)	27,7 (60.0)
46,0 (155)	18,3 (38.4)	19,1 (40.1)	20,0 (41.9)	22,0 (45.9)	23,1 (48.1)
50,0 (170)	15,6 (32.1)	16,2 (33.5)	16,9 (34.9)	18,5 (37.9)	19,3 (39.5)
56,0 (185)	12,5 (27.2)	13,0 (28.3)	13,5 (29.4)	14,5 (31.7)	15,1 (33.0)
60,0 (200)	10,8 (23.2)	11,2 (24.1)	11,7 (25.0)	12,6 (26.9)	13,1 (27.9)
64,0 (215)				10,9 (22.9)	11,3 (23.8)
70,0 (230)					
74,0 (245)					
76,0 (255)					

Boom m (ft) Radius	61,0	67,1	73,2	85,3	91,4
	(200)	(220)	(240)	(280)	(300)
Luffing jib length 61,0 m (200 ft)	34,0 (115)				
38,0 (125)	21,5 (47.3)	— (48.5)	— (49.6)		
42,0 (140)	18,8 (40.6)	19,4 (41.9)	20,0 (43.2)	20,6 (44.7)	20,6 (45.0)
46,0 (155)	16,3 (34.5)	16,9 (35.8)	17,5 (37.0)	18,4 (39.1)	18,7 (39.9)
50,0 (170)	14,1 (29.1)	14,6 (30.3)	15,2 (31.4)	16,2 (33.7)	16,6 (34.6)
56,0 (185)	11,2 (24.4)	11,7 (25.4)	12,2 (26.5)	13,1 (28.6)	13,6 (27.7)
60,0 (200)	9,5 (20.2)	9,9 (21.2)	10,4 (22.1)	11,3 (24.1)	11,8 (25.1)
64,0 (215)	8,0 (16.6)	8,4 (17.4)	8,8 (18.3)	9,7 (20.1)	10,1 (21.0)
70,0 (230)	6,1 (13.6)	6,5 (14.3)	6,8 (15.0)	7,5 (16.6)	7,9 (17.4)
74,0 (245)		5,4 (11.8)	5,7 (12.2)	6,3 (13.5)	6,6 (14.2)
76,0 (255)				5,8 (11.9)	6,0 (12.5)

Meets ANSI B30.5 Requirements - Capacities do not exceed 75% of static tipping load.

NOTICE: This capacity chart is for reference only and must not be used for lifting purposes.

Luffing jib load charts

MAX-ER® 2000

Liftcrane luffing jib capacities - MAX-ER 2000 on 2250

Luffing jib No. 133A or No. 133 on

Boom No. 79-44 with 39,6 m (130 ft) Mast No. 44

76 750 kg (169,200 lb) Crane counterweight, 27 220 kg (60,000 lb) Carbody counterweight
209 560 kg (462,000 lb) Wheeled counterweight at 15,2 m (50') position
360° Rating kg (lb) x1 000

70° Boom angle

Luffing jib length	70° Boom angle					Luffing jib length	70° Boom angle					
	61,0 (200)	67,1 (220)	73,2 (240)	85,3 (280)	91,4 (300)		61,0 (200)	67,1 (220)	73,2 (240)	85,3 (280)	91,4 (300)	
21,3 m (70 ft)	34,0 (115)	— (132.8)				36,6 m (120 ft)	34,0 (115)					
	38,0 (125)	47,2 (103.4)	— (122.0)				38,0 (125)					
	40,0 (135)	41,0 (84.1)	47,5 (96.5)	56,3 (112.7)			40,0 (135)					
	44,0 (145)	32,2 (70.3)	36,3 (79.3)	41,5 (90.4)	— (91.9)		44,0 (145)	— (72.6)				
	46,0 (155)			36,5 (74.9)	39,7 (84.6)		46,0 (155)	29,8 (61.7)	33,5 (68.8)	— (77.5)		
	50,0 (165)				35,6 (77.9)		50,0 (165)	24,4 (53.3)	27,0 (58.8)	30,1 (65.4)		
	54,0 (180)						54,0 (180)	20,5 (43.7)	22,4 (47.7)	24,6 (52.3)	27,5 (59.7)	25,6 (55.6)
	58,0 (195)						58,0 (195)	17,4 (36.5)	18,9 (39.5)	20,6 (43.0)	24,9 (51.4)	23,6 (50.5)
	64,0 (210)						64,0 (210)				19,1 (42.3)	20,7 (45.7)
	68,0 (225)						68,0 (225)					17,7 (38.3)

Luffing jib length	70° Boom angle					Luffing jib length	70° Boom angle					
	61,0 (200)	67,1 (220)	73,2 (240)	85,3 (280)	91,4 (300)		61,0 (200)	67,1 (220)	73,2 (240)	85,3 (280)	91,4 (300)	
48,8 m (160 ft)	54,0 (180)	20,2 (43.1)	22,2 (47.2)	— (51.9)		61,0 m (200 ft)	54,0 (180)					
	56,0 (190)	18,6 (38.0)	20,3 (41.4)	22,3 (45.2)	— (48.4)		56,0 (190)	— (34.1)	— (36.6)			
	60,0 (200)	15,8 (33.7)	17,1 (36.5)	18,7 (39.7)	21,1 (45.9)		60,0 (200)	14,3 (30.6)	15,4 (33.0)	— (35.3)		
	64,0 (210)	13,6 (30.1)	14,7 (32.5)	15,9 (35.2)	18,8 (41.6)		64,0 (210)	12,3 (27.3)	13,4 (29.6)	14,4 (31.8)	16,2 (35.8)	
	66,0 (220)	12,7 (27.0)	13,6 (29.0)	14,7 (31.4)	17,4 (36.8)		66,0 (220)	11,4 (24.3)	12,4 (26.4)	13,4 (28.5)	15,2 (32.6)	— (31.7)
	72,0 (235)	— (23.0)	11,0 (24.7)	11,9 (26.6)	13,8 (30.9)		72,0 (235)	9,0 (20.2)	9,8 (22.1)	10,7 (24.0)	12,5 (28.0)	13,2 (29.4)
	76,0 (250)				11,9 (26.2)		76,0 (250)	7,6 (16.7)	8,3 (18.3)	9,1 (20.0)	10,8 (23.7)	11,6 (25.6)
	80,0 (265)						80,0 (265)	6,3 (13.6)	7,0 (15.0)	7,7 (16.5)	9,2 (19.8)	10,0 (21.5)
	84,0 (280)						84,0 (280)		5,8 (12.3)	6,4 (13.5)	7,8 (16.3)	8,5 (17.9)
	88,0 (295)						88,0 (295)				6,6 (13.4)	7,2 (14.7)
92,0 (305)					92,0 (305)					6,1 (12.9)		

Meets ANSI B30.5 Requirements - Capacities do not exceed 75% of static tipping load.

NOTICE: This capacity chart is for reference only and must not be used for lifting purposes.

Fixed jib on luffing jib range diagram

MAX-ER® 2000

No. 140 Fixed jib on No. 133A or No. 133 Fixed jib on No. 79-44 Long-reach boom

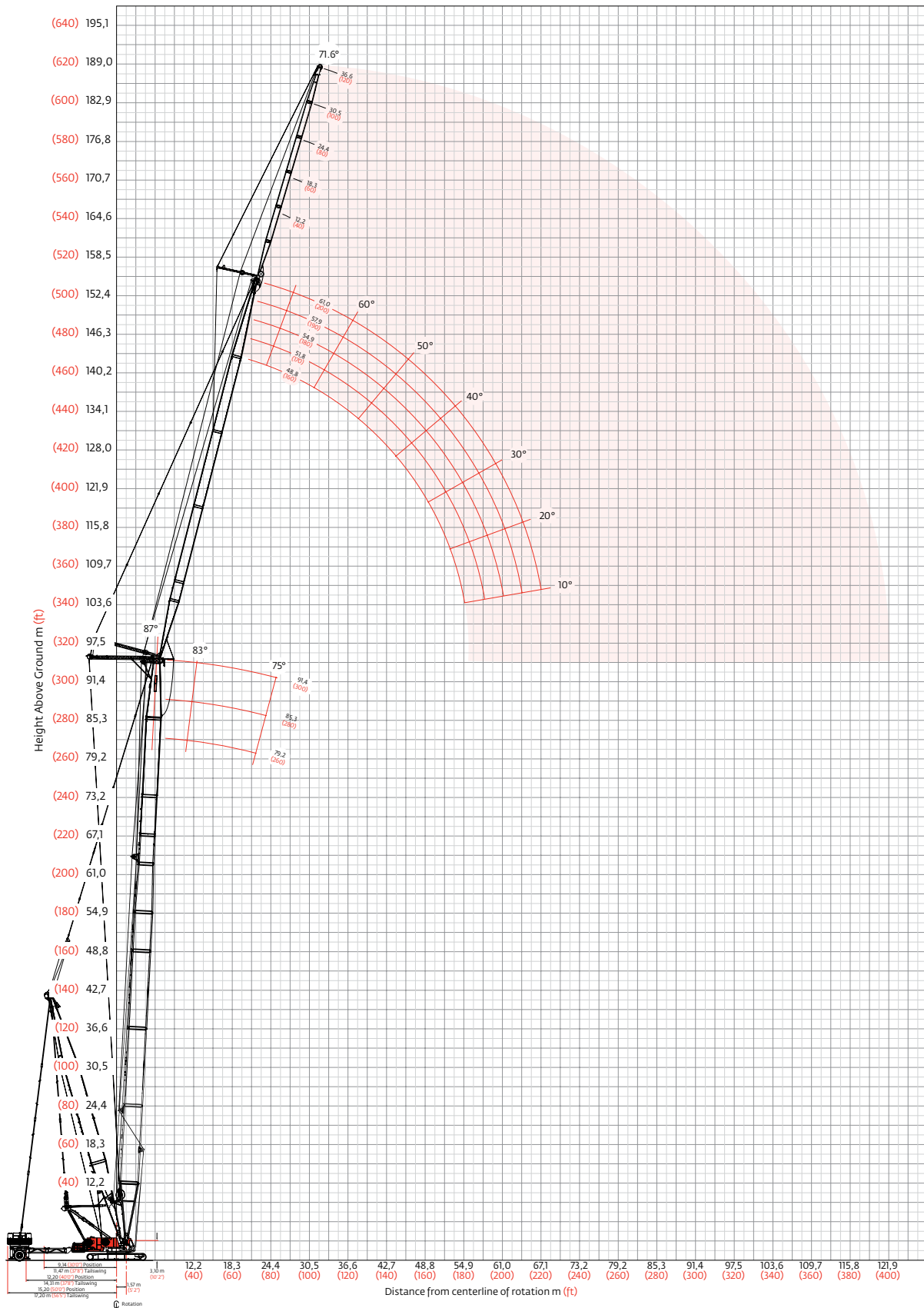

Fixed jib on luffing jib load charts

MAX-ER® 2000

Liftcrane fixed jib capacities - MAX-ER 2000 on 2250

Fixed jib No. 140 Set at 5 Degree offset angle on

Luffing jib No. 133A or No. 133 on Boom No. 79-44 with 39,6 m (130 ft) Mast No. 44

76 750 kg (169,200 lb) Crane counterweight, 27 220 kg (60,000 lb) Carbody counterweight
209 560 kg (462,000 lb) Wheeled counterweight at 15,2 m (50') position
360° Rating kg (lb) x1 000

87° Boom angle

Luffing jib m (ft)	48,8 (160)			51,8 (170)			57,9 (190)			61,0 (200)		
	79,2 (260)	85,4 (280)	91,5 (300)	79,2 (260)	85,4 (280)	91,5 (300)	79,2 (260)	85,4 (280)	91,5 (300)	79,2 (260)	85,4 (280)	91,5 (300)
Radius	24,4 (80)	24,9 (54.9)	22,7 (50.1)									
6,0 (90)	25,8 (55.4)	24,6 (53.9)	22,4 (49.1)	23,8 (52.5)	22,7 (49.2)	20,8 (45.5)	— (43.1)	18,7 (41.2)	— (38.8)			
0,0 (100)	23,9 (52.3)	23,6 (51.7)	21,7 (47.8)	23,3 (50.9)	22,1 (48.8)	20,2 (44.4)	19,3 (42.6)	18,3 (40.5)	17,3 (38.1)	17,5 (38.6)	16,7 (36.8)	15,9 (35.0)
36,0 (120)	20,5 (44.0)	20,9 (44.7)	20,4 (44.8)	20,4 (43.6)	20,5 (44.2)	19,1 (41.9)	19,0 (41.9)	18,1 (39.7)	16,5 (36.2)	17,1 (37.8)	16,4 (36.2)	15,2 (33.5)
44,0 (150)	14,3 (29.4)	14,5 (29.8)	14,7 (30.2)	14,1 (29.0)	14,3 (29.4)	14,5 (29.8)	13,5 (27.8)	13,8 (28.2)	14,0 (28.6)	13,3 (27.2)	13,5 (27.6)	13,7 (28.0)
54,0 (180)	9,5 (20.5)	9,7 (20.7)	9,8 (21.0)	9,4 (20.0)	9,5 (20.3)	9,6 (20.5)	8,8 (18.9)	8,9 (19.1)	9,0 (19.4)	8,5 (18.2)	8,7 (18.5)	8,8 (18.8)
60,0 (200)	7,6 (16.2)	7,7 (16.4)	7,8 (16.6)	7,4 (15.7)	7,4 (15.9)	7,6 (16.1)	6,8 (14.6)	6,9 (14.8)	7,0 (15.0)	6,5 (14.0)	6,7 (14.2)	6,8 (14.4)
66,0 (220)	6,0 (12.7)	6,0 (12.8)	6,1 (13.0)	5,8 (12.3)	5,9 (12.5)	5,9 (12.6)	5,2 (11.1)	5,3 (11.3)	5,4 (11.5)	5,0 (10.5)	5,1 (10.7)	5,1 (10.9)
72,0 (240)							4,0 (8.3)	4,0 (8.5)	4,1 (8.6)	3,7 (7.7)	3,7 (7.7)	3,8 (8.0)
76,0 (260)							3,2 (—)	3,2 (—)	3,3 (—)	2,9 (5.3)	3,0 (5.5)	3,1 (5.6)

Luffing jib m (ft)	48,8 (160)			51,8 (170)			57,9 (190)			61,0 (200)		
	79,2 (260)	85,4 (280)	91,5 (300)	79,2 (260)	85,4 (280)	91,5 (300)	79,2 (260)	85,4 (280)	91,5 (300)	79,2 (260)	85,4 (280)	91,5 (300)
Radius	— (110)	— (18.5)	— (18.3)	— (18.1)	— (18.2)	— (17.9)						
36,0 (120)	8,0 (17.7)	8,0 (17.5)	7,9 (17.3)	7,9 (17.4)	7,8 (17.2)	7,7 (17.0)	7,5 (16.6)	7,4 (16.4)	— (16.1)	— (16.1)	— (15.8)	15,5 (15.5)
42,0 (140)	7,3 (16.1)	7,3 (16.0)	7,2 (15.9)	7,2 (15.9)	7,2 (15.8)	7,1 (15.6)	7,0 (15.4)	6,9 (15.2)	6,8 (15.0)	6,8 (15.0)	6,7 (14.8)	6,6 (14.6)
48,0 (160)	6,7 (14.7)	6,6 (14.6)	6,6 (14.5)	6,6 (14.6)	6,6 (14.5)	6,6 (14.4)	6,5 (14.2)	6,4 (14.1)	6,3 (13.9)	6,3 (13.9)	6,2 (13.7)	6,2 (13.6)
54,0 (180)	6,2 (13.5)	6,1 (13.4)	6,1 (13.4)	6,1 (13.4)	6,1 (13.3)	6,1 (13.3)	6,0 (13.1)	5,9 (13.1)	5,9 (13.0)	5,8 (12.9)	5,8 (12.8)	5,8 (12.7)
60,0 (200)	5,7 (12.4)	5,7 (12.4)	5,6 (12.4)	5,6 (12.4)	5,6 (12.4)	5,6 (12.3)	5,5 (12.2)	5,5 (12.1)	5,5 (12.1)	5,5 (12.1)	5,4 (11.9)	5,4 (11.9)
66,0 (220)	5,3 (11.6)	5,3 (11.6)	5,3 (11.6)	5,3 (11.6)	5,2 (11.5)	5,2 (11.5)	5,2 (11.4)	5,1 (11.4)	5,1 (11.3)	5,1 (11.3)	5,1 (11.2)	5,0 (11.1)
72,0 (240)	4,9 (10.9)	4,9 (10.8)	4,9 (10.8)	4,9 (10.7)	4,9 (10.8)	4,9 (10.8)	4,5 (9.5)	4,6 (9.7)	4,6 (9.8)	4,2 (8.9)	4,3 (9.1)	4,4 (9.2)
76,0 (260)	4,5 (8.7)	4,5 (8.8)	4,6 (8.9)	4,2 (8.2)	4,3 (8.4)	4,4 (8.5)	3,7 (7.1)	3,8 (7.2)	3,8 (7.3)	3,4 (6.5)	3,5 (6.6)	3,6 (6.7)
84,0 (280)	3,1 (6.6)	3,2 (6.7)	3,2 (6.8)	2,9 (6.2)	3,0 (6.3)	3,1 (6.4)	2,4 (5.0)	2,5 (5.1)	2,5 (5.2)	2,1 (4.4)	2,2 (4.5)	2,2 (4.6)

Meets ANSI B30.5 Requirements - Capacities do not exceed 75% of static tipping load.

NOTICE: This capacity chart is for reference only and must not be used for lifting purposes.

Fixed jib on luffing jib load charts

MAX-ER® 2000

Liftcrane fixed jib capacities - MAX-ER 2000 on 2250
 Fixed jib No. 140 Set at 5 Degree offset angle on
 Luffing jib No. 133A or No. 133 on Boom No. 79-44 with 39,6 m (130 ft) Mast No. 44

76 750 kg (169,200 lb) Crane counterweight, 27 220 kg (60,000 lb) Carbody counterweight
 209 560 kg (462,000 lb) Wheeled Counterweight at 15,2 m (50') position
 360° Rating kg (lb) x1000
83° Boom angle

Luffing jib m (ft)	48,8 (160)			51,8 (170)			57,9 (190)			61,0 (200)			
	79,2 (260)	85,4 (280)	91,5 (300)	79,2 (260)	85,4 (280)	91,5 (300)	79,2 (260)	85,4 (280)	91,5 (300)	79,2 (260)	85,4 (280)	91,5 (300)	
Boom m (ft)	— (110)	— (54.8)	— (51.3)	—	—	—	—	—	—	—	—	—	
Radius	36,0 (120)	23,7 (51.9)	23,2 (51.3)	21,8 (48.1)	22,6 (49.9)	21,1 (46.7)	— (44.0)	— (41.1)	— (38.6)	—	—	—	
12,2 m (40 ft) 5° offset	42,0 (140)	20,1 (42.9)	20,9 (44.4)	21,3 (46.0)	19,9 (42.5)	20,5 (44.0)	19,9 (43.9)	18,4 (40.5)	17,3 (38.2)	16,4 (36.2)	16,6 (36.6)	15,7 (34.6)	14,8 (32.8)
	48,0 (160)	15,3 (32.7)	15,8 (33.8)	16,3 (34.9)	15,1 (32.3)	15,6 (33.3)	16,1 (34.4)	14,5 (31.1)	15,0 (32.1)	15,7 (33.2)	14,3 (30.5)	14,9 (31.5)	14,7 (32.5)
	54,0 (180)	11,9 (25.5)	12,3 (26.2)	12,7 (27.0)	11,7 (25.0)	12,1 (25.8)	12,4 (26.6)	11,2 (23.9)	11,5 (24.6)	11,9 (25.4)	10,9 (23.2)	11,3 (24.0)	11,6 (24.8)
	60,0 (200)	9,4 (20.1)	9,7 (20.7)	10,0 (21.3)	9,2 (19.6)	9,5 (20.2)	9,8 (20.8)	8,7 (18.4)	8,9 (19.0)	9,2 (19.6)	8,4 (17.8)	8,7 (18.4)	8,9 (19.0)
	66,0 (220)	7,4 (15.9)	7,7 (16.3)	7,9 (16.8)	7,2 (15.4)	7,5 (15.9)	7,7 (16.4)	6,7 (14.2)	6,9 (14.7)	7,2 (15.2)	6,4 (13.6)	6,7 (14.1)	6,9 (14.6)
	72,0 (240)	5,8 (12.4)	6,0 (12.8)	6,2 (13.2)	5,7 (12.0)	5,8 (12.4)	6,0 (12.8)	5,2 (10.9)	5,3 (11.3)	5,5 (11.6)	4,9 (10.3)	5,1 (10.7)	5,3 (11.0)
	76,0 (260)	—	—	—	4,8 (—)	4,9 (—)	5,1 (—)	4,3 (8.1)	4,4 (8.4)	4,6 (8.7)	4,0 (7.5)	4,2 (7.8)	4,3 (8.1)
	84,0 (280)	—	—	—	—	—	—	—	—	—	2,5 (5.1)	2,6 (5.4)	2,8 (5.7)

Luffing jib m (ft)	48,8 (160)			51,8 (170)			57,9 (190)			61,0 (200)			
	79,2 (260)	85,4 (280)	91,5 (300)	79,2 (260)	85,4 (280)	91,5 (300)	79,2 (260)	85,4 (280)	91,5 (300)	79,2 (260)	85,4 (280)	91,5 (300)	
Boom m (ft)	44,0 (145)	— (16.9)	— (16.8)	—	—	—	—	—	—	—	—	—	
Radius	46,0 (155)	7,4 (16.2)	7,4 (16.1)	7,4 (16.0)	7,3 (16.0)	7,3 (15.9)	— (15.8)	— (15.3)	— (15.2)	—	—	—	
36,6 m (120 ft) 5° offset	50,0 (170)	7,0 (15.1)	7,0 (15.1)	7,0 (15.1)	6,9 (15.0)	6,9 (14.9)	6,8 (14.9)	6,7 (14.5)	6,6 (14.4)	6,5 (14.3)	6,5 (14.1)	6,4 (14.0)	— (13.8)
	56,0 (185)	6,4 (14.2)	6,4 (14.2)	6,4 (14.1)	6,4 (14.1)	6,3 (14.0)	6,3 (14.0)	6,2 (13.7)	6,2 (13.6)	6,1 (13.5)	6,0 (13.4)	6,0 (13.3)	6,0 (13.2)
	60,0 (200)	6,1 (13.3)	6,1 (13.3)	6,1 (13.3)	6,0 (13.2)	6,0 (13.2)	6,0 (13.2)	5,9 (12.9)	5,9 (12.9)	5,8 (12.8)	5,8 (12.7)	5,7 (12.6)	5,7 (12.5)
	66,0 (220)	5,6 (12.3)	5,6 (12.3)	5,6 (12.3)	5,6 (12.3)	5,6 (12.2)	5,6 (12.2)	5,5 (12.0)	5,5 (12.0)	5,5 (12.0)	5,4 (11.9)	5,4 (11.8)	5,4 (11.8)
	72,0 (240)	5,2 (11.5)	5,2 (11.5)	5,2 (11.5)	5,2 (11.4)	5,2 (11.5)	5,2 (11.5)	5,1 (11.3)	5,1 (11.3)	5,1 (11.3)	5,1 (11.1)	5,1 (11.1)	5,0 (11.0)
	76,0 (260)	5,0 (10.8)	5,0 (10.8)	5,0 (10.8)	5,0 (10.4)	5,0 (10.7)	5,0 (10.7)	4,8 (9.3)	4,9 (9.6)	4,9 (9.9)	4,6 (8.7)	4,7 (9.0)	4,8 (9.3)
	84,0 (280)	4,0 (8.5)	4,2 (8.8)	4,3 (9.1)	3,8 (8.0)	4,0 (8.3)	4,1 (8.6)	3,3 (6.9)	3,4 (7.2)	3,5 (7.4)	3,1 (6.3)	3,1 (6.6)	3,3 (6.8)
	88,0 (300)	3,4 (6.5)	3,5 (6.7)	3,6 (6.9)	3,2 (6.0)	3,3 (6.2)	3,4 (6.5)	2,6 (4.9)	2,8 (5.1)	2,9 (5.3)	2,4 (4.3)	2,5 (4.5)	2,6 (4.7)

Meets ANSI B30.5 Requirements - Capacities do not exceed 75% of static tipping load.

NOTICE: This capacity chart is for reference only and must not be used for lifting purposes.

Fixed jib on luffing jib load charts

MAX-ER® 2000

Liftcrane fixed jib capacities - MAX-ER 2000 on 2250

Fixed jib No. 140 Set at 5 Degree offset angle on

Luffing jib No. 133A or No. 133 on Boom No. 79-44 with 39,6 m (130 ft) Mast No. 44

76 750 kg (169,200 lb) Counterweight 27 220 kg (60,000 lb) Carbody counterweight
209 560 kg (462,000 lb) Wheeled counterweight at 15,2 m (50') position
360° Rating kg (lb) x 1 000

75° Boom angle

Luffing jib m (ft)	48,8 (160)			51,8 (170)			57,9 (190)			61,0 (200)		
	79,2 (260)	85,4 (280)	91,5 (300)	79,2 (260)	85,4 (280)	91,5 (300)	79,2 (260)	85,4 (280)	91,5 (300)	79,2 (260)	85,4 (280)	91,5 (300)
Boom m (ft)	— (170)	— (46.8)	—	—	—	—	—	—	—	—	—	—
Radius	— (170)	— (46.8)	—	—	—	—	—	—	—	—	—	—
12.2 m (40 ft) 5° offset	54,0 (180)	19,1 (40.5)	20,0 (43.6)	— (41.8)	18,9 (40.1)	— (40.7)	—	—	—	—	—	—
56,0 (190)	17,4 (35.4)	18,8 (37.9)	19,1 (40.7)	17,2 (34.9)	18,2 (37.5)	— (38.3)	— (33.7)	— (33.4)	—	—	— (32.2)	—
60,0 (200)	14,6 (31.1)	15,6 (33.2)	16,8 (35.5)	14,4 (30.6)	15,4 (32.8)	16,7 (35.1)	13,9 (29.4)	15,0 (31.6)	14,2 (31.4)	13,7 (28.8)	13,6 (30.1)	— (28.2)
66,0 (220)	11,4 (24.3)	12,2 (25.8)	13,0 (27.5)	11,2 (23.8)	12,0 (25.4)	12,8 (27.1)	10,7 (22.6)	11,4 (24.2)	12,3 (25.9)	10,4 (22.0)	11,1 (23.6)	12,0 (25.3)
72,0 (240)	9,0 (19.1)	9,6 (20.3)	10,2 (21.6)	8,8 (18.7)	9,4 (19.9)	10,0 (21.2)	8,3 (17.5)	8,9 (18.7)	9,5 (20.0)	8,0 (16.9)	8,6 (18.1)	9,2 (19.4)
76,0 (260)	7,7 (15.1)	8,2 (16.1)	8,7 (17.1)	7,5 (14.7)	8,0 (15.6)	8,5 (16.7)	7,0 (13.5)	7,5 (14.5)	8,0 (15.5)	6,7 (12.9)	7,2 (13.9)	7,7 (14.9)
84,0 (280)	—	6,0 (12.6)	6,4 (13.4)	5,4 (11.4)	5,8 (12.2)	6,2 (13.0)	4,9 (10.3)	5,3 (11.1)	5,7 (11.9)	4,6 (9.7)	5,0 (10.5)	5,4 (11.3)
88,0 (300)	—	—	—	—	4,9 (—)	5,2 (—)	4,1 (7.6)	4,4 (8.3)	4,7 (8.9)	3,8 (7.0)	4,1 (7.7)	4,4 (8.4)
96,0 (320)	—	—	—	—	—	—	—	—	3,1 (—)	2,4 (—)	2,6 (5.3)	2,9 (5.9)
36.6 m (120 ft) 5° offset	68,0 (225)	6,2 (13.6)	6,2 (13.7)	— (13.7)	6,1 (13.5)	— (13.5)	—	—	—	—	—	—
72,0 (240)	5,9 (12.8)	5,9 (12.9)	5,9 (13.0)	5,8 (12.8)	5,8 (12.8)	5,9 (12.8)	5,6 (12.4)	5,6 (12.4)	— (12.3)	5,5 (12.1)	— (12.0)	—
76,0 (250)	5,6 (12.4)	5,6 (12.5)	5,6 (12.5)	5,5 (12.3)	5,6 (12.4)	5,6 (12.4)	5,4 (12.0)	5,4 (12.0)	5,4 (12.0)	5,3 (11.8)	5,3 (11.7)	5,2 (11.6)
80,0 (270)	5,3 (11.6)	5,4 (11.6)	5,4 (11.7)	5,3 (11.5)	5,4 (11.6)	5,3 (11.6)	5,2 (11.3)	5,2 (11.3)	5,2 (11.3)	5,1 (11.1)	5,1 (11.1)	5,0 (11.0)
88,0 (290)	4,9 (10.8)	4,9 (10.9)	5,0 (11.0)	4,9 (10.8)	4,9 (10.9)	4,9 (10.9)	4,6 (10.1)	4,8 (10.6)	4,8 (10.7)	4,3 (9.5)	4,6 (10.2)	4,7 (10.5)
92,0 (310)	4,6 (9.2)	4,7 (9.8)	4,8 (10.4)	4,3 (8.7)	4,6 (9.3)	4,7 (10.0)	3,8 (7.6)	4,1 (8.2)	4,4 (8.8)	3,6 (7.0)	3,9 (7.6)	4,2 (8.2)
100,0 (330)	3,2 (7.0)	3,5 (7.6)	3,7 (8.1)	3,0 (6.6)	3,3 (7.1)	3,5 (7.6)	2,5 (5.4)	2,8 (6.0)	3,0 (6.5)	2,2 (4.8)	2,5 (5.4)	2,7 (5.9)
104,0 (350)	2,7 (5.2)	2,9 (5.6)	3,1 (6.1)	2,4 (4.7)	2,7 (5.2)	2,9 (5.7)	1,9 (—)	2,2 (4.1)	2,4 (4.5)	—	—	2,1 (—)
108,0 (360)	2,1 (—)	2,3 (4.7)	2,5 (5.2)	1,9 (—)	2,1 (4.3)	2,3 (4.8)	—	—	1,8 (—)	—	—	—

Meets ANSI B30.5 Requirements - Capacities do not exceed 75% of static tipping load.

NOTICE: This capacity chart is for reference only and must not be used for lifting purposes.

Outline dimensions

M-1200 RINGER®

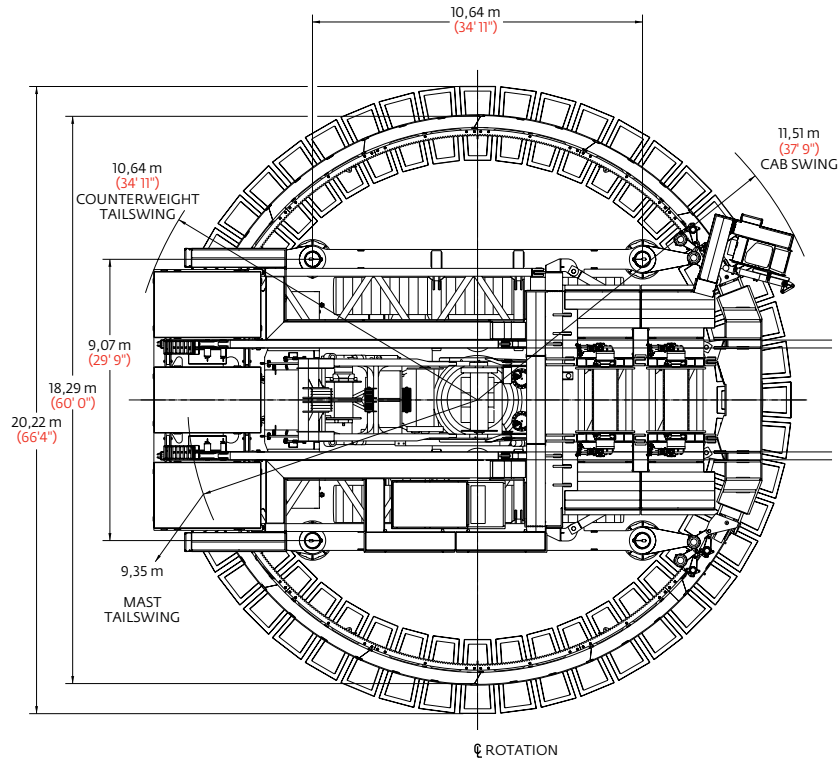

NOTE: ALL VERTICAL DIMENSIONS ARE BASED ON 0,61 m (2) CLEARANCE BETWEEN UNDERSIDE OF RING AND GROUND.

VERTICAL DIMENSIONS WILL VARY DEPENDING ON HEIGHT ADJUSTMENT OF RING.

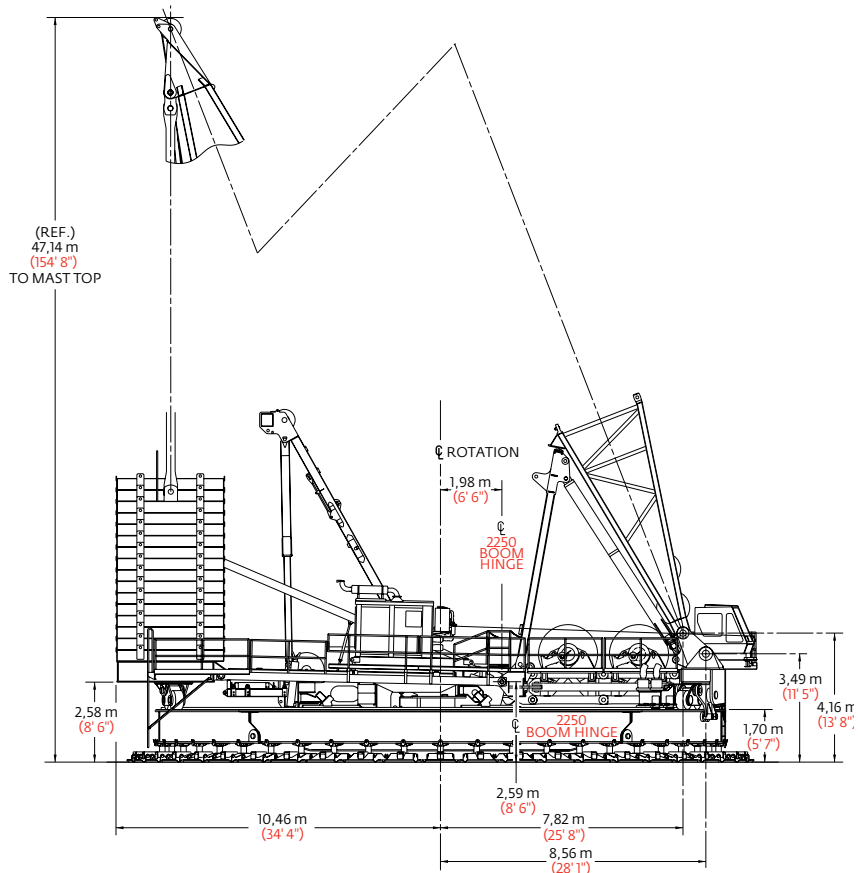

Performance data

M-1200 RINGER®

M-1200 RINGER® Configurations			
Maximum capacity m-ton (U.S. ton)	800 (882)	1300 (1,433)	800 (882)
Configuration	Single engine, one hoist drum	Dual engines, two hoist drums	Dual engines, two hoist drums
Boom number	75A	72 or 72 A	75 Jib on 72 or 72A Boom
Basic length	45,7 m (150')	46,6 m (153')	30,5 m (100')
Maximum length	121,9 m (400')	122,8 m (403')	76,2 m (250')
Mast number	75A	75A	75A
Mast length	45,7 m (150')	45,7 m (150')	45,7 m (150')
Number of RINGER- SWINGER® Drives	2	4	4
Boom hoist	One or two full-width hoist drums of Model 2250 crane	Two full-width hoist drums of Model 2250 crane	Two full-width hoist drums of Model 2250 crane
Load hoist	One or two full-width drums mounted to RINGER attachment	Two full-width drums mounted to RINGER attachment	Two full-width drums mounted to RINGER attachment

M-1200 RINGER® System functions		
Component or system	One RINGER hoist drum	Two RINGER hoist drums
2250 Front drum	Boom hoist	Boom hoist
2250 Rear drum	Boom hoist - optional	Boom hoist
2250 Boom hoist	Mast hoist	Mast hoist
RINGER front hoist drum	None	Load hoist
RINGER rear hoist drum	Load hoist	Load hoist
2250 Engine	Powers swing, load hoist, travel, and boom hoist	Powers half of swing and load hoist, all of travel and boom hoist
RINGER auxiliary engine	Optional: Complements power for load hoist and swing	Complements power for load hoist and swing

Performance data

M-1200 RINGER®

Wire rope lengths Boom No. 72 or No. 72A with Mast No. 75 or No. 75A

m (ft)	Tandem drums					Whip line Auxiliary RINGER drum			
	Hoist line rear RINGER drum		Hoist line front RINGER drum		Maximum required parts of line	(4 Parts of line)		(6 Parts of line)	
	m	(ft)	m	(ft)		m	(ft)	m	(ft)
46,6 (153)	1 219	(4,000)	1 219	(4,000)	48	290	(950)	396	(1,300)
54,3 (178)	1 402	(4,600)	1 402	(4,600)	48	335	(1,100)	457	(1,500)
61,9 (203)	1 585	(5,200)	1 585	(5,200)	48	366	(1,200)	503	(1,650)
69,5 (228)	1 646	(5,400)	1 646	(5,400)	44	411	(1,350)	564	(1,850)
77,1 (253)	1 676	(5,500)	1 676	(5,500)	40	442	(1,450)	610	(2,000)
84,7 (278)	1 676	(5,500)	1 676	(5,500)	36	488	(1,600)	671	(2,200)
92,4 (303)	1 676	(5,500)	1 676	(5,500)	32	518	(1,700)	716	(2,350)
100,0 (328)	1 676	(5,500)	1 676	(5,500)	28	549	(1,800)	777	(2,550)
107,6 (353)	1 676	(5,500)	1 676	(5,500)	28	594	(1,950)	823	(2,700)
115,2 (378)	1 676	(5,500)	1 676	(5,500)	24	625	(2,050)	884	(2,900)
122,8 (403)	1 676	(5,500)	1 676	(5,500)	20	671	(2,200)	930	(3,050)

Note: Hoist line lengths are based on tandem drums both reeved to main load block. Each drum is dead-ended in main load block reeving. Total parts of line requires use of both RINGER® drums. Line lengths given in table will allow hook to touch ground. When block travel below ground is required, add additional rope equal to parts of line times added travel distance. Hoisting distance or line pull may be limited when block travel below ground is required.

Wire rope lengths Boom No. 75A with Mast No. 75/49A, No. 75 or No. 75A

m (ft)	Hoist line			Whip line Auxiliary RINGER drum			
	Rear RINGER drum		Maximum required parts of line	(4 Parts of line)		(6 Parts of line)	
	m	(ft)		m	(ft)	m	(ft)
45,7 (150)	1 524	(5,000)	32	290	(950)	396	(1,300)
53,3 (175)	1 798	(5,900)	32	335	(1,100)	457	(1,500)
61,0 (200)	1 798	(5,900)	28	366	(1,200)	503	(1,650)
68,6 (225)	1 798	(5,900)	24	411	(1,350)	564	(1,850)
76,2 (250)	1 981	(6,500)	24	442	(1,450)	610	(2,000)
83,8 (275)	1 981	(6,500)	20	488	(1,600)	671	(2,200)
91,4 (300)	1 981	(6,500)	20	518	(1,700)	716	(2,350)
99,1 (325)	1 981	(6,500)	16	549	(1,800)	777	(2,550)
106,7 (350)	1 981	(6,500)	16	594	(1,950)	823	(2,700)
114,3 (375)	1 981	(6,500)	12	625	(2,050)	884	(2,900)
121,9 (400)	1 981	(6,500)	12	671	(2,200)	930	(3,050)

Note: Line lengths given in table are based on single-part lead line and will allow hook to touch ground. When block travel below ground is required, add additional rope equal to parts of line times added travel distance. Hoisting distance or line pull may be limited when block travel below ground is required.

Performance data

M-1200 RINGER®

Wire rope lengths Jib No. 75 on Boom No. 72 or No. 72A with Mast No. 75 or No. 75A

Boom length m (ft)	RINGER® Tandem drums - hoist line															
	(32 Parts of line)				(28 Parts of line)				(24 Parts of line)				(20 Parts of line)			
	Rear		Front		Rear		Front		Rear		Front		Rear		Front	
	m	(ft)	m	(ft)	m	(ft)	m	(ft)	m	(ft)	m	(ft)	m	(ft)	m	(ft)
92,4 (303)	1 615	(5,300)	1 615	(5,300)												
100,0 (328)	1 737	(5,700)	1 737	(5,700)												
107,6 (353)	1 859	(6,100)	1 859	(6,100)	1 646	(5,400)	1 646	(5,400)								
115,2 (378)	1 981	(6,500)	1 981	(6,500)	1 768	(5,800)	1 768	(5,800)	1 524	(5,000)	1 524	(5,000)				
122,8 (403)	—	—	—	—	1 859	(6,100)	1 859	(6,100)	1 615	(5,300)	1 615	(5,300)				
130,5 (428)	—	—	—	—	—	—	—	—	1 707	(5,600)	1 707	(5,600)	1 463	(4,800)	1 463	(4,800)
138,1 (453)	—	—	—	—	—	—	—	—	1 829	(6,000)	1 829	(6,000)	1 554	(5,100)	1 554	(5,100)
145,7 (478)	—	—	—	—	—	—	—	—	—	—	—	—	1 615	(5,300)	1 615	(5,300)
153,3 (503)	—	—	—	—	—	—	—	—	—	—	—	—	1 707	(5,600)	1 707	(5,600)

Note: Hoist line lengths are based on tandem drums both reeved to main jib block. Each drum is dead-ended in main jib block reeving. Total parts of line requires use of both RINGER® drums. Line lengths given in table will allow hook to touch ground. When block travel below ground is required, add additional rope equal to parts of line times added travel distance. Hoisting distance or line pull may be limited when block travel below ground is required.

Drums and laggings - M-1200 RINGER®

Application	Tandem RINGER drums					
	Drum location	Part number	Type of drum or lagging	Diameter	Width	Wire rope size
Liftcrane	Hoist	Rear	173396	Bare Drum 749 mm (29-1/2")	1 972 mm (77-5/8")	42 mm (1-5/8")
	Hoist (optional)	Front	173396	Bare Drum 749 mm (29-1/2")	1 972 mm (77-5/8")	42 mm (1-5/8")
	Hoist (optional)	Rear	502368	Grooved Lagging 826 mm (32-1/2")	1 972 mm (77-5/8")	42 mm (1-5/8")
	Hoist (optional)	Front	502368	Grooved Lagging 826 mm (32-1/2")	1 972 mm (77-5/8")	42 mm (1-5/8")
	Whip (optional)	Auxiliary	175812	Bare Drum 724 mm (28-1/2")	1 397 mm (55")	29 mm (1-1/8")

Note: Rear drum application required with boom No. 75A.

Tandem drum application required with boom No. 72, No. 72A, or No. 72/75A, and with jib No. 75 on boom No. 72 or No. 72A.

Performance data

M-1200 RINGER®

Drums - 266,9 kN (60,000 lb)

Layer Line pull kN (lb)	Single line pull/single line speed* at low or high range m/min (ft/min)																					
	1		2		3		4		5		6		7		8		9		10		11	
	Low	High	Low	High	Low	High	Low	High	Low	High	Low	High	Low	High	Low	High	Low	High	Low	High	Low	High
0 (0)	25 (82)	45 (149)	27 (90)	50 (163)	30 (97)	54 (177)	32 (105)	59 (192)	34 (113)	63 (206)	37 (121)	67 (220)	39 (128)	71 (234)	41 (136)	76 (248)	44 (144)	80 (263)	46 (152)	84 (277)	49 (160)	89 (291)
44,5 (10,000)	25 (81)	44 (145)	27 (89)	48 (159)	30 (97)	52 (172)	32 (104)	56 (185)	34 (112)	60 (196)	36 (119)	64 (211)	39 (127)	69 (225)	41 (135)	72 (237)	43 (142)	76 (250)	46 (150)	80 (263)	48 (157)	84 (276)
89,0 (20,000)	25 (81)	43 (141)	27 (88)	47 (154)	29 (96)	51 (166)	31 (103)	55 (179)	34 (111)	58 (191)	36 (118)	62 (203)	38 (126)	66 (215)	41 (133)	69 (227)	43 (141)	73 (238)	45 (148)	76 (250)	47 (155)	80 (261)
133,4 (30,000)	24 (80)	42 (137)	27 (88)	45 (149)	29 (95)	49 (161)	31 (102)	52 (172)	34 (110)	56 (183)	36 (117)	59 (194)	38 (124)	62 (205)	40 (132)	66 (216)	42 (139)	69 (226)	45 (146)	72 (236)	47 (153)	75 (246)
18144 (40,000)	24 (80)	—	27 (87)	—	29 (94)	—	31 (101)	—	33 (109)	—	35 (116)	—	37 (123)	—	40 (130)	—	42 (137)	—	44 (144)	—	46 (151)	—
22 680 (50,000)	24 (79)	—	26 (86)	—	28 (93)	—	31 (101)	—	33 (108)	—	35 (115)	—	37 (122)	—	39 (129)	—	41 (136)	—	43 (142)	—	45 (149)	—
27 216 (60,000)	24 (78)	—	26 (86)	—	28 (93)	—	30 (100)	—	33 (107)	—	34 (113)	—	37 (120)	—	39 (127)	—	41 (134)	—	43 (140)	—	45 (147)	—

NOTE: Line pull is infinitely variable.

*Based on lagging diameter of 826 mm (32-1/2").

Wire rope specifications

Boom No. 72, No. 72A or No. 75A with
Mast No. 75, No. 75A

- or -

Boom No. 75A with

Mast No. 75/49A, No. 75 or No. 75A

- or -

Fixed jib No. 75 on

Boom No. 72, No. 72A or No. 75A

Function	5:1 Safety factor Rotation resistant 1 960N/mm ² , right hand regular lay	5:1 Safety factor Rotation resistant 1 960N/mm ²
Part number	No. 719404	No. 719375
Size wire rope	— (1-5/8")	— (1-1/8")
Minimum breaking strength	147 200 kg (324,520 lb)	70 260 kg (154,900 lb)
Maximum load per line	27 088 kg (59,719 lb)	13 610 kg (30,000 lb)
Approximate weight	7,89 kg/m (5.30 lb/ft)	4,02 kg/m (2.70 lb/ft)

Drum capacities - wire rope

RINGER Drums	Maximum length	
	Bare drum	With lagging*
RINGER Drums Front or rear drum (hoist) 42 mm (1-5/8") Wire rope	1 995 m (6,544 ft) 12 Layers	1 923 m (6,309 ft) 11 Layers
Auxiliary drum (whip) 29 mm (1-1/8") Wire rope	1 047 m (3,522 ft) 8 Layers	— —

8 m (27') is deducted from maximum spooling capacities for 3 dead wraps per drum or lagging.

*Lagging diameter 826 mm (32-1/2").

Heavy-lift boom range diagram

M-1200 RINGER®

No. 72 or 72A Boom

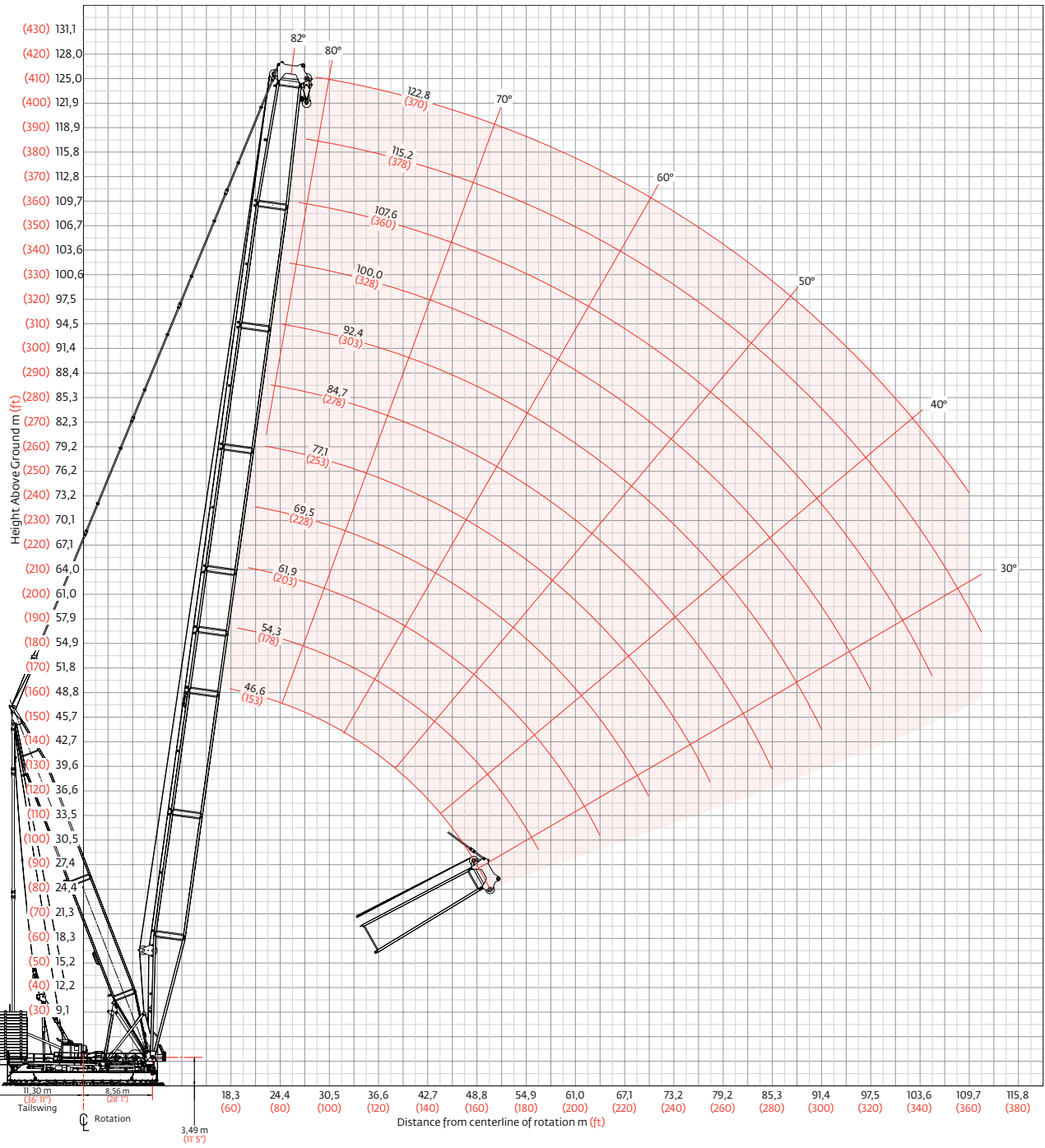

Heavy-lift boom load charts

M-1200 RINGER®

Liftcrane capacities - M-1200

Boom No. 72 with 1 300 m-ton (1,433 ton) Boom point

Mast No. 75 or No. 75A

18,3 m (60') RINGER® Attachment on screw jack pedestals

Boom m (ft) Radius	23 590 kg (52,000 lb) Crane counterweight 915 170 kg (2,017,600 lb) Auxiliary counterweight 360° Rating kg (lb) x 1 000										
	46,6 (153)	54,3 (178)	61,9 (203)	69,5 (228)	77,1 (253)	84,7 (278)	92,4 (303)	100,0 (328)	107,6 (353)	115,2 (378)	122,8 (403)
17,1 (56)	1300,0 (2,866.5)										
18,0 (60)	1300,0 (2,866.5)										
20,0 (70)	1160,7 (2,277.2)	1155,9 (2,269.2)	1153,3 (2,263.2)	— (2,254.8)	— (2,246.3)						
24,0 (80)	847,5 (1,821.7)	843,8 (1,813.4)	841,0 (1,807.4)	837,1 (1,798.6)	833,1 (1,789.9)	832,4 (1,783.8)	— (1,741.3)				
26,0 (90)	745,6 (1,511.5)	741,8 (1,503.2)	739,0 (1,497.0)	735,0 (1,488.1)	731,0 (1,479.2)	728,2 (1,473.0)	722,3 (1,464.2)	679,9 (1,393.5)	640,4 (1,311.5)	— (1,241.6)	
30,0 (100)	597,7 (1,286.8)	593,9 (1,278.3)	591,0 (1,272.1)	587,0 (1,263.1)	582,9 (1,254.1)	580,0 (1,247.8)	576,0 (1,238.8)	561,6 (1,213.2)	527,9 (1,140.1)	498,9 (1,077.2)	472,1 (1,017.6)
34,0 (110)	495,9 (1,116.3)	492,1 (1,107.9)	489,3 (1,101.6)	485,1 (1,092.5)	481,0 (1,083.4)	478,1 (1,077.1)	474,0 (1,068.0)	471,0 (1,061.3)	449,1 (1,008.1)	423,5 (950.9)	398,9 (895.9)
36,0 (120)	456,1 (982.6)	452,2 (974.2)	449,4 (967.9)	445,2 (958.7)	441,0 (949.6)	438,2 (943.2)	434,0 (934.0)	431,0 (927.3)	417,7 (902.7)	393,6 (850.4)	370,0 (799.2)
42,0 (140)	364,8 (786.3)	361,0 (777.8)	358,1 (771.6)	354,0 (762.4)	349,8 (753.1)	346,9 (746.7)	342,7 (737.5)	339,6 (730.6)	335,4 (721.4)	323,4 (698.9)	302,9 (654.2)
48,0 (160)	287,2 (608.5)	297,3 (640.6)	294,4 (634.3)	290,3 (625.1)	286,1 (615.9)	283,2 (609.4)	278,9 (600.1)	275,8 (593.2)	271,6 (584.0)	268,4 (576.8)	254,4 (549.2)
54,0 (180)		250,2 (539.0)	247,5 (533.0)	243,3 (523.8)	239,1 (514.5)	236,1 (508.0)	231,9 (498.7)	228,8 (491.8)	224,6 (482.5)	221,3 (475.3)	216,8 (466.0)
60,0 (200)			211,3 (454.9)	207,2 (445.8)	203,0 (436.5)	200,1 (430.1)	195,8 (420.8)	192,7 (413.9)	188,5 (404.5)	185,2 (397.3)	180,9 (388.0)
66,0 (220)				178,5 (383.9)	174,3 (374.7)	171,4 (368.3)	167,2 (359.0)	164,1 (352.0)	159,8 (342.7)	156,5 (335.4)	152,3 (326.1)
72,0 (240)					151,1 (324.4)	148,2 (318.1)	144,0 (308.7)	140,8 (301.8)	136,6 (292.5)	133,3 (285.2)	129,0 (275.9)
78,0 (260)						128,9 (276.4)	124,7 (267.1)	121,6 (260.2)	117,3 (250.8)	114,0 (243.6)	109,8 (234.2)
84,0 (280)							108,5 (231.9)	105,4 (225.1)	101,1 (215.8)	97,8 (208.5)	93,6 (199.2)
90,0 (300)							94,6 (201.9)	91,5 (195.1)	87,3 (185.8)	84,0 (178.6)	79,7 (169.2)
96,0 (320)								79,5 (169.1)	75,3 (159.9)	72,0 (152.7)	67,8 (143.4)
100,0 (330)									68,1 (148.2)	64,9 (141.0)	60,7 (131.7)
102,0 (340)									64,8 (137.2)	61,6 (130.1)	57,3 (120.8)
106,0 (350)										55,3 (119.8)	51,1 (110.5)
108,0 (360)										52,4 (110.0)	48,1 (100.8)
110,0 (365)										49,3 (102.1)	

Heavy-lift boom range diagram

M-1200 RINGER®

No. 75A Boom

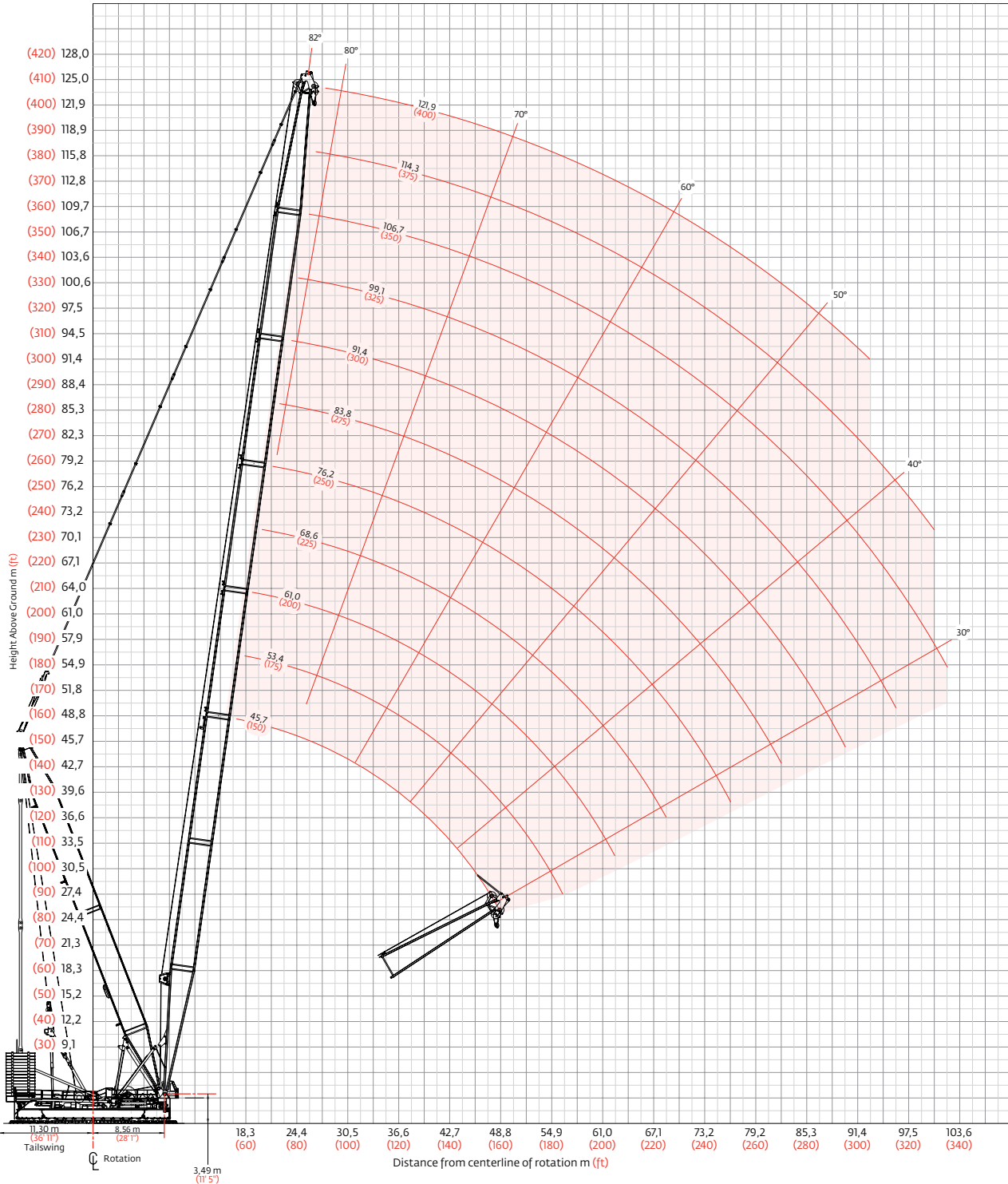

Heavy-lift boom load charts

M-1200 RINGER®

Liftcrane capacities - M-1200

Boom No. 75A

Mast No. 75 or No. 75A

18,3 m (60') RINGER® Attachment on screw jack pedestals

Boom m (ft) Radius	23 590 kg (52,000 lb) Crane counterweight 715 590 kg (1,577,600 lb) Auxiliary counterweight 360° Rating kg (lb) x1 000										
	45,7 (150)	53,3 (175)	61,0 (200)	68,6 (225)	76,2 (250)	83,8 (275)	91,4 (300)	99,1 (325)	106,7 (350)	114,3 (375)	121,9 (400)
16,8 (55)	816,4 (1,800.0)	720,2 (1,587.8)									
18,0 (60)	816,4 (1,800.0)	720,2 (1,587.8)	— (1,444.7)								
20,0 (70)	814,4 (1,764.0)	720,2 (1,587.8)	650,1 (1,417.7)	578,9 (1,263.9)	— (1,132.1)	— (1,016.4)					
24,0 (80)	699,4 (1,494.8)	688,8 (1,490.6)	628,9 (1,382.2)	561,8 (1,235.1)	504,2 (1,108.6)	453,7 (997.9)	405,0 (890.8)	— (784.5)	— (695.5)		
30,0 (90)	478,1 (1,228.7)	491,6 (1,240.2)	489,4 (1,235.5)	488,9 (1,205.9)	478,7 (1,084.5)	429,0 (978.2)	375,2 (856.4)	331,6 (755.9)	294,6 (671.0)	260,7 (593.1)	229,3 (516.2)
36,0 (100)	348,5 (1,026.1)	377,3 (1,058.8)	375,1 (1,054.1)	373,4 (1,050.2)	371,2 (1,045.3)	364,2 (939.3)	343,2 (821.9)	305,7 (726.6)	271,4 (645.6)	239,4 (571.3)	208,6 (501.8)
42,0 (120)	261,4 (747.1)	292,7 (813.4)	301,6 (808.7)	299,8 (804.8)	297,6 (799.9)	296,0 (786.7)	284,5 (746.5)	270,5 (668.6)	246,8 (593.4)	216,3 (523.0)	187,7 (455.5)
48,0 (140)	194,4 (558.2)	228,3 (627.5)	247,0 (650.4)	248,5 (646.5)	246,3 (641.6)	244,6 (638.0)	239,7 (614.8)	229,0 (584.9)	217,1 (538.1)	194,4 (471.5)	167,1 (408.8)
54,0 (160)	— (411.2)	176,3 (487.6)	198,5 (529.5)	210,1 (535.9)	208,5 (531.1)	206,8 (527.4)	204,6 (517.6)	196,8 (495.0)	187,1 (469.4)	173,3 (422.6)	147,8 (362.8)
60,0 (180)		— (373.3)	157,8 (424.1)	172,9 (450.4)	179,1 (449.5)	177,8 (445.8)	175,5 (440.8)	170,6 (424.9)	162,9 (404.3)	153,3 (375.9)	129,0 (320.0)
66,0 (200)			— (334.6)	140,7 (369.5)	150,0 (383.8)	153,6 (383.1)	152,2 (378.1)	148,6 (367.9)	142,5 (351.5)	134,1 (331.1)	111,0 (278.0)
72,0 (220)				— (298.5)	124,2 (320.4)	130,5 (329.3)	131,3 (327.0)	129,5 (319.8)	125,1 (307.2)	116,5 (288.8)	94,4 (238.1)
76,0 (240)					107,7 (263.4)	116,4 (278.8)	118,7 (281.4)	118,1 (278.2)	114,6 (269.0)	105,4 (249.7)	84,0 (201.5)
78,0 (250)					— (235.8)	109,6 (255.3)	112,7 (260.4)	112,7 (259.2)	109,7 (251.7)	100,1 (231.3)	79,1 (184.3)
82,0 (260)						96,2 (232.5)	101,0 (240.4)	102,3 (241.2)	100,3 (235.3)	89,8 (213.6)	69,5 (167.7)
84,0 (270)						— (209.9)	95,4 (221.0)	97,3 (224.0)	95,8 (219.7)	84,8 (196.4)	64,9 (151.8)
88,0 (280)							84,3 (202.2)	87,7 (207.5)	87,1 (204.8)	75,2 (179.9)	56,0 (136.4)
90,0 (290)							— (183.5)	83,0 (191.4)	83,0 (190.4)	70,5 (163.9)	51,7 (121.6)
94,0 (300)								73,7 (175.9)	74,9 (176.6)	61,5 (148.3)	— (107.2)
96,0 (310)								69,0 (160.0)	70,9 (163.1)	57,1 (133.3)	
98,0 (320)									67,0 (149.8)	52,7 (118.6)	
100,0 (330)									63,0 (136.5)	48,5 (104.3)	
102,0 (335)									59,1 (129.9)		

Meets ANSI B30.5 Requirements - Capacities do not exceed 75% of static tipping load.

NOTICE: This capacity chart is for reference only and must not be used for lifting purposes.

Fixed jib range diagram

M-1200 RINGER®

No. 75 Jib on No. 72 Boom

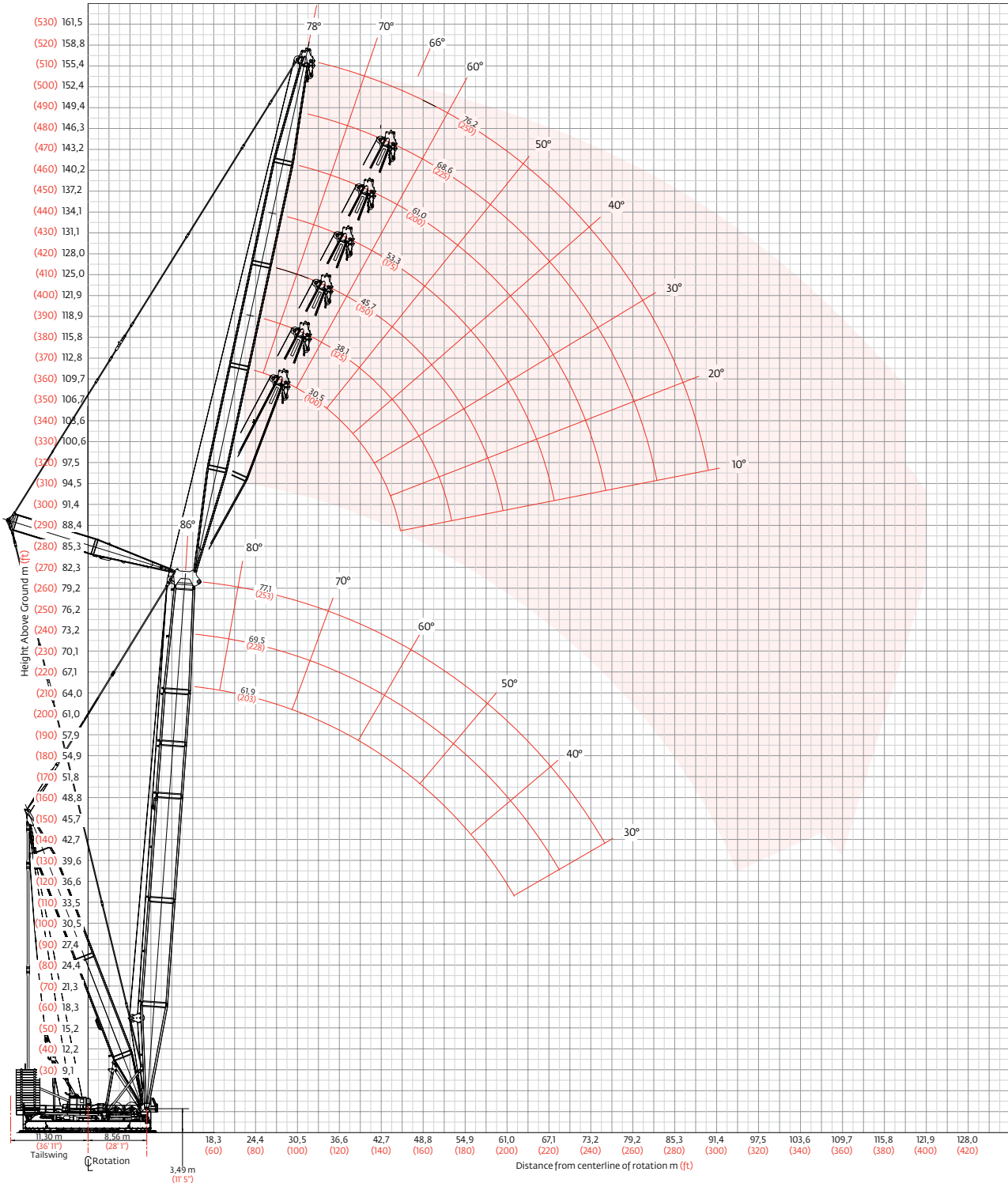

Fixed jib load charts

M-1200 RINGER®

Liftcrane capacities - M-1200
Jib No 75 with 25,1 m (82' 6") Strut on Boom No. 72
Mast No. 75 or No. 75A
18,3 m (60') RINGER® Attachment on screw jack pedestals

		23 590 kg (52,000 lb) Crane counterweight 915 170 kg (2,017,600 lb) Auxiliary counterweight 360° Rating kg (lb) x1 000						
		8° Offset			20° Offset			
Boom m (ft) Radius		61,9 (203)	69,5 (228)	77,1 (253)	Boom m (ft) Radius	61,9 (203)	69,5 (228)	77,1 (253)
Jib length 30,5 m (100 ft)	22,9 (75)	781,0 (1,721.9)	800,0 (1,764.0)	800,0 (1,764.0)	30,0 (95)	352,2 (797.1)	374,7 (846.6)	387,9 (874.7)
	26,0 (90)	683,1 (1,423.9)	729,2 (1,512.1)	745,4 (1,505.1)	32,0 (105)	335,4 (739.5)	357,8 (788.9)	371,7 (819.6)
	32,0 (105)	539,2 (1,188.7)	535,9 (1,181.4)	532,3 (1,173.5)	36,0 (120)	306,0 (666.3)	328,2 (715.0)	343,3 (748.8)
	38,0 (125)	412,8 (906.4)	409,2 (898.5)	405,2 (889.8)	42,0 (140)	270,1 (587.7)	291,5 (634.8)	307,9 (671.1)
	44,0 (150)	328,8 (682.9)	325,1 (674.6)	320,9 (665.3)	50,0 (170)	232,9 (497.8)	253,2 (542.1)	268,8 (560.5)
	58,0 (200)	211,6 (429.4)	207,7 (420.8)	203,2 (410.9)	62,0 (210)	191,7 (405.7)	190,9 (398.3)	187,1 (389.7)
	74,0 (250)	138,4 (288.9)	134,4 (280.2)	129,9 (270.1)	74,0 (250)	141,8 (295.9)	138,4 (288.4)	134,4 (279.6)
	90,0 (300)	91,3 (187.9)	89,5 (190.2)	84,9 (180.2)	86,0 (290)	104,9 (217.9)	101,7 (210.9)	97,7 (202.1)
	98,0 (330)		71,4 (137.4)	68,2 (139.9)	98,0 (330)		73,8 (144.9)	70,3 (143.9)
	106,0 (350)			52,0 (110.3)	106,0 (350)			54,5 (117.0)
	110,0 (370)				110,0 (370)			

		8° Offset			20° Offset			
Boom m (ft) Radius		61,9 (203)	69,5 (228)	77,1 (253)	Boom m (ft) Radius	61,9 (203)	69,5 (228)	77,1 (253)
Jib length 45,7 m (150 ft)	25,9 (85)	613,3 (1,352.3)	652,2 (1,438.0)	652,7 (1,439.0)	30,0 (95)			
	26,0 (90)	611,1 (1,270.1)	650,1 (1,360.5)	651,8 (1,406.6)	32,0 (115)	— (627.6)	— (643.1)	— (652.4)
	32,0 (105)	486,1 (1,071.7)	523,7 (1,154.5)	536,8 (1,183.4)	36,0 (120)	278,4 (605.6)	285,8 (622.3)	290,2 (632.3)
	38,0 (125)	401,5 (882.7)	412,8 (906.5)	409,2 (898.6)	42,0 (140)	243,8 (530.1)	252,7 (550.1)	258,2 (562.4)
	44,0 (150)	332,1 (689.9)	328,4 (681.8)	324,5 (673.1)	50,0 (170)	208,1 (443.8)	218,4 (466.9)	224,6 (480.8)
	58,0 (200)	214,6 (435.9)	210,7 (427.3)	206,4 (417.7)	62,0 (210)	169,1 (361.2)	180,4 (386.5)	187,0 (401.0)
	74,0 (250)	141,3 (295.4)	137,3 (286.5)	132,8 (276.6)	74,0 (250)	141,2 (301.9)	143,8 (300.2)	140,1 (292.0)
	90,0 (300)	96,4 (205.6)	92,4 (196.8)	87,8 (186.7)	86,0 (290)	110,2 (229.6)	106,8 (222.2)	103,0 (213.6)
	98,0 (330)	79,6 (160.0)	75,8 (156.8)	71,3 (146.7)	98,0 (330)	82,6 (171.0)	79,3 (163.8)	75,4 (155.2)
	106,0 (350)	56,6 (120.4)	61,8 (134.0)	57,3 (124.0)	106,0 (350)	62,4 (132.6)	64,4 (139.6)	60,6 (131.1)
	110,0 (370)			51,1 (103.8)	110,0 (370)		57,5 (110.4)	53,9 (109.4)

Meets ANSI B30.5 Requirements - Capacities do not exceed 75% of static tipping load.

NOTICE: This capacity chart is for reference only and must not be used for lifting purposes.

Fixed jib load charts

M-1200 RINGER®

Liftcrane capacities - M-1200
Jib No 75 with 25,1 m (82' 6") Strut on Boom No. 72
Mast No. 75 or No. 75A
18,3 m (60') RINGER® Attachment on screw jack pedestals

		23 590 kg (52,000 lb) Crane counterweight 915 170 kg (2,017,600 lb) Auxiliary counterweight 360° Rating kg (lb) x1 000						
		8° Offset			20° Offset			
Boom m (ft) Radius	8° Offset			Boom m (ft) Radius	20° Offset			
	61,9 (203)	69,5 (228)	77,1 (253)		61,9 (203)	69,5 (228)	77,1 (253)	
Jib length 61,0 m (200 ft)	29,0 (95)	455,4 (1,004.2)	485,3 (1,070.1)	502,2 (1,107.3)	42,0 (135)	216,6 (486.6)	222,0 (498.3)	225,3 (505.3)
	32,0 (105)	406,5 (896.2)	434,9 (958.7)	457,6 (1,008.8)	44,0 (145)	207,3 (455.3)	213,1 (468.0)	216,6 (475.9)
	34,0 (115)	379,2 (807.4)	406,9 (866.7)	428,9 (915.2)	48,0 (160)	190,8 (414.3)	197,0 (428.0)	201,0 (437.1)
	38,0 (125)	333,5 (733.2)	359,1 (789.4)	380,3 (836.1)	54,0 (180)	169,8 (368.4)	176,4 (383.1)	180,8 (393.0)
	44,0 (150)	280,8 (591.6)	303,9 (641.2)	323,6 (679.1)	58,0 (200)	157,8 (330.2)	164,6 (345.6)	169,2 (356.0)
	58,0 (200)	200,8 (416.0)	212,6 (431.3)	208,6 (422.4)	70,0 (230)	128,8 (283.6)	136,1 (299.7)	141,0 (310.4)
	74,0 (250)	142,8 (298.6)	138,9 (290.0)	134,7 (280.6)	82,0 (270)	107,3 (235.7)	114,8 (252.3)	117,6 (257.6)
	90,0 (300)	97,9 (208.9)	93,9 (200.1)	89,5 (190.4)	94,0 (310)	90,8 (199.0)	90,8 (198.0)	87,1 (189.9)
	106,0 (350)	67,4 (146.3)	63,4 (137.5)	59,0 (127.7)	106,0 (350)	71,0 (154.1)	67,7 (146.8)	63,9 (138.4)
	110,0 (370)	58,7 (115.3)	57,2 (117.4)	52,8 (107.6)	114,0 (380)	56,8 (115.1)	54,9 (115.4)	51,1 (107.0)
	118,0 (390)				118,0 (400)		49,2 —	

		8° Offset			20° Offset			
Boom m (ft) Radius	8° Offset			Boom m (ft) Radius	20° Offset			
	61,9 (203)	69,5 (228)	77,1 (253)		61,9 (203)	69,5 (228)	77,1 (253)	
Jib length 76,2 m (250 ft)	29,0 (95)				42,0 (135)			
	32,0 (105)	362,1 (798.3)	384,2 (847.1)	385,3 (849.5)	44,0 (155)	— (361.4)	— (381.9)	— (392.3)
	34,0 (115)	336,7 (715.7)	359,7 (765.2)	376,5 (804.9)	48,0 (160)	161,2 (349.5)	170,5 (370.1)	175,3 (380.8)
	38,0 (125)	294,3 (646.9)	315,6 (693.8)	333,1 (732.2)	54,0 (180)	142,0 (307.7)	151,2 (328.0)	156,5 (339.7)
	44,0 (150)	245,6 (516.1)	264,9 (557.5)	281,1 (592.4)	58,0 (200)	131,1 (273.0)	140,2 (292.8)	145,6 (305.1)
	58,0 (200)	172,0 (354.8)	187,6 (387.9)	201,3 (416.9)	70,0 (230)	104,7 (230.6)	113,3 (249.5)	119,2 (262.5)
	74,0 (250)	122,5 (258.9)	135,4 (286.5)	135,0 (281.2)	82,0 (270)	85,1 (186.9)	93,2 (204.9)	99,4 (218.2)
	90,0 (300)	90,8 (195.3)	94,0 (200.2)	89,7 (190.9)	94,0 (310)	70,1 (153.4)	77,6 (170.0)	83,9 (183.8)
	106,0 (350)	67,5 (146.4)	63,5 (137.8)	59,2 (128.2)	106,0 (350)	58,1 (126.8)	65,2 (142.4)	65,8 (142.6)
	110,0 (370)	61,3 (126.4)	57,4 (117.9)	53,0 (108.2)	114,0 (380)	51,4 (110.3)	56,8 (119.1)	53,0 (111.1)
	118,0 (390)	47,4 (100.9)			118,0 (400)	48,4 (100.7)	50,9 (100.8)	47,3 —

Meets ANSI B30.5 Requirements - Capacities do not exceed 75% of static tipping load.

NOTICE: This capacity chart is for reference only and must not be used for lifting purposes.

Outline dimensions

Elevated cab

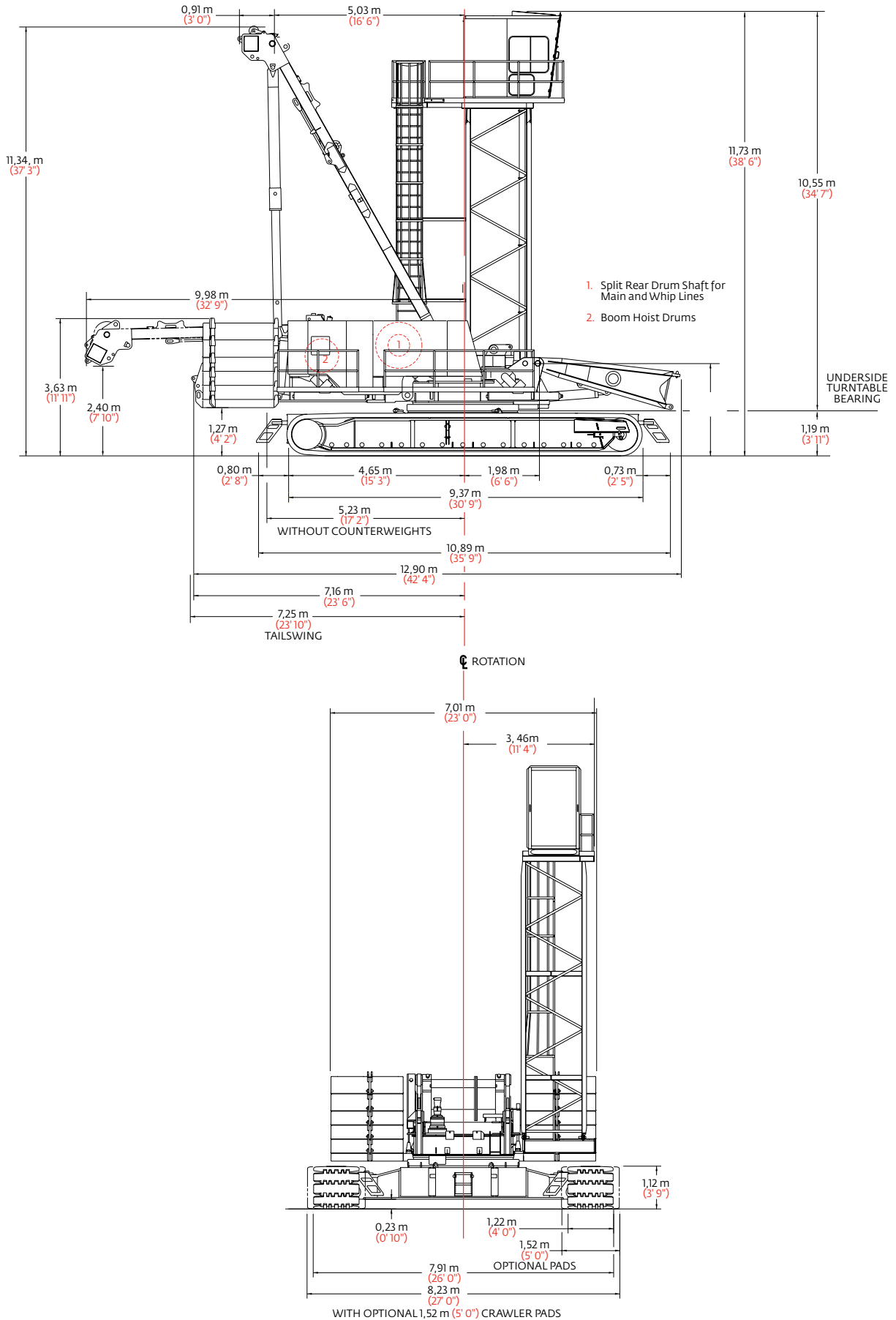

Boom combinations

Container handling

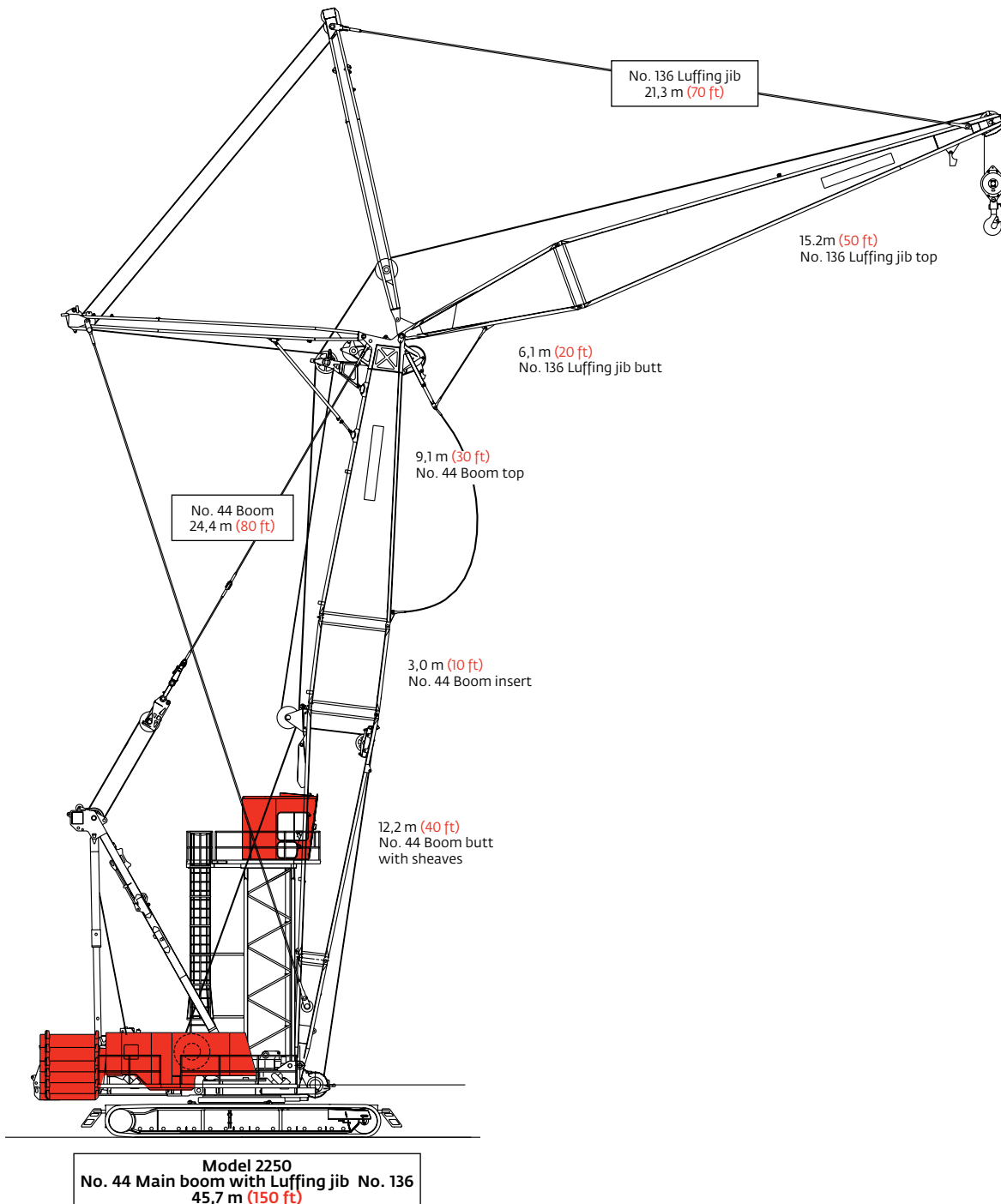

Performance data

Container handling

Liftcrane luffing jib capacities - 2250 Series 2 Special Container handling Luffing Jib No. 136 on Boom No. 44 with heavy lift top

94 890 kg (209,200 lb) Crane counterweight
68 040 kg (150,000 lb) Carbody counterweight
6 800 kg (15,000 lb) Minimum weight required on capacities indicated by (b)
24,4 m (80') Boom with 21,3 m (70') Luffing jib shown.
For other combinations, consult factory.
360° Rating kg (lb) x 1 000

Jib Radius	Boom angle						
	88°	83°	80°	75°	70°	65°	60°
8,5 (28)	45,3b (100.0)b	— —	— —	— —	— —	— —	— —
9,0 (30)	45,3b (100.0)b	— —	— —	— —	— —	— —	— —
10,0 (32)	45,3b (100.0)b	— —	— —	— —	— —	— —	— —
— (34)	— (100.0)b	— —	— —	— —	— —	— —	— —
11,0 (36)	45,3b (100.0)b	— —	— —	— —	— —	— —	— —
— (38)	— (100.0)	— —	— —	— —	— —	— —	— —
12,0 (40)	45,3b (100.0)b	— —	— —	— —	— —	— —	— —
14,0 (45)	45,3b (100.0)b	45,3b (100.0)b	— —	— —	— —	— —	— —
16,0 (50)	45,3b (100.0)b	45,3b (100.0)b	45,3b (100.0)b	— —	— —	— —	— —
18,0 (55)	45,3 (100.0)b	45,3b (100.0)b	45,3b (100.0)b	— —	— —	— —	— —
20,0 (60)	42,9 (100.0)	45,2b (100.0)b	45,3b (100.0)b	— —	— —	— —	— —
— (65)	— (95.4)	— (100.0)b	— (100.0)b	— (100.0)b	— —	— —	— —
22,0 (70)	39,1 (89.1)	43,6 (98.4)	44,8b (100.0)b	45,3b (100.0)b	— —	— —	— —
24,0 (75)	30,8 (82.4)	39,6 (91.8)	42,1 (97.4)	45,3 (100.0)b	45,3b (100.0)b	— —	— —
— (80)	— (61.4)	— (86.0)	— (91.0)	— (100.0)	— (100.0)b	— —	— —
26,0 (85)		— (76.2)	38,4 (85.2)	42,2 (93.6)	45,2 (100.0)	45,1b (100.0)b	— —
28,0 (90)			— (75.7)	38,7 (87.6)	42,6 (96.0)	41,4 (93.6)	— —
— (95)				— (82.2)	— (89.9)	— (87.6)	— —
30,0 (100)					38,9 (84.2)	38,0 (82.2)	— (80.1)
32,0 (105)					35,7 (78.8)	35,1 (77.4)	34,2 (75.5)
— (110)						— (73.0)	— (71.3)
34,0 (115)							31,7 (67.4)

Manitowoc Crane Care

Crane Care is Manitowoc's comprehensive service and support program. It includes classroom and on-site training, prompt parts availability, expert field service, technical support and documentation.

That's commitment you won't find anywhere else.

That's Crane Care.

Service training

Manitowoc specialists work with you in our training centers and in the field to make sure you know how to get maximum performance, reliability and life from your cranes.

Manitowoc Cranes Technical Training Centers provide valuable multi-level training, which is available for all models and attachments, in the following format:

- **Intro to Canbus and Canbus 1, 2, 3**
- **Intro to EPIC and EPIC 1, 2, 3**
- **Small Crawler 1**
- **Canbus 1 and 2 assembly, operation and maintenance**
- **EPIC 1 and 2 assembly, operation and maintenance**

Refer to www.manitowoc.com for course descriptions.

Parts availability

Genuine Manitowoc replacement parts are accessible through your distributor 24 hours a day, 7 days a week, 365 days a year.

Service interval kits

200 hour kit

1,000 hour kit

2,000 hour kit

Hydraulic test kit

U.S. standard tools kit

Field service

Factory-trained service experts are always ready to help maintain your crane's peak performance.

For a worldwide listing of dealer locations, please consult our website at: www.manitowoc.com

Technical support

Manitowoc's dealer network and factory personnel are available 24 hours a day, 7 days a week, 365 days a year to answer your technical questions and more, with the help of computerized programs that simplify crane selection, lift planning, and ground-bearing calculations.

For a worldwide listing of dealer locations, please consult our website at: www.manitowoc.com

Technical documentation

Manitowoc has the industry's most extensive documentation; available in major languages and formats that include print, videotape, and DVD/CD.

Additional copies available through your Authorized Manitowoc Distributor.

- Crane operator's manual
- Crane parts manual
- Crane capacity manual
- Crane vendor manual
- Crane service manual
- Luffing jib operator's/parts manual
- Capacity chart manual - attachments

CD rom versions of the operator's and parts manuals are shipped with each crane. Also available are the following CDs:

- Crane Care Owner CD –
- Ground Bearing Pressure Estimator CD
- Crane Selection and Planning Software (CompuCRANE®)
- EPIC® Crane Library CD consisting of capacity charts, range diagrams, wire rope specifications, travel specifications, crane weights, counterweight arrangements, luffing jib raising procedures, operating range diagrams, drum and lagging charts, boom rigging drawings, jib rigging drawings, outline dimensions and wind condition charts.

Available from your Authorized Manitowoc Cranes Distributor, these videos are available in NTSC, PAL, SECAM, and DVD formats.

- Your Capacity Chart Video
- Respect the Limits Video
- Crane Safety Video
- Boom Inspection/Repair Video

Crane Care Package

Manitowoc has assembled all of the available literature, CD's and videos listed above plus several Manitowoc premiums into one complete Crane Care Package.

Regional headquarters

Manitowoc - Americas

Manitowoc, Wisconsin, USA

Tel: +1 920 684 6621

Fax: +1 920 683 6277

Shady Grove, Pennsylvania, USA

Tel: +1 717 597 8121

Fax: +1 717 597 4062

Manitowoc - Europe, Middle East, Africa

Ecully, France

Tel: +33 (0)4 72 18 20 20

Fax: +33 (0)4 72 18 20 00

Manitowoc - Asia Pacific

Shanghai, China

Tel: +86 21 6457 0066

Fax: +86 21 6457 4955

Regional offices

Americas

Brazil

Alphaville

Mexico

Monterrey

Chile

Santiago

Europe, Middle East, Africa

Czech Republic

Netvorice

France

Baudemont

Cergy

Decines

Germany

Langenfeld

Hungary

Budapest

Italy

Parabiago

Netherlands

Breda

Poland

Warsaw

Portugal

Baltar

Russia

Moscow

U.A.E.

Dubai

U.K.

Gawcott

Asia - Pacific

Australia

Brisbane

Melbourne

Sydney

China

Beijing

Xi'an

India

Hyderabad

Pune

Korea

Seoul

Philippines

Makati City

Singapore

Factories

Brazil

Alphaville

China

TaiAn

Zhangjiagang

France

Charlieu

La Clayette

Moulins

Germany

Wilhelmshaven

India

Pune

Italy

Niella Tanaro

Portugal

Baltar

Fânzeres

Slovakia

Saris

USA

Manitowoc

Port Washington

Shady Grove

This document is non-contractual. Constant improvement and engineering progress make it necessary that we reserve the right to make specification, equipment, and price changes without notice. Illustrations shown may include optional equipment and accessories and may not include all standard equipment.