

# Series **800D**

## product guide

### features

- 100' ft (30.48 m) Four-Section Boom
- 23 USt (20.87 t) Rating
- Easy Glide Wear Pads
- Internal Anti-two-block



### contents

Features

2

Mounting Configurations

3

Specifications

4

Capacities

5

Accessories

13

Dimensions Specifications

14

# features

## Why Buy a National Crane Series 800D?

2



\*Product may be shown with optional equipment.

- **23 USt (20.87 t) Rating** – The 800D is a 23 USt (20.87 t) machine.
- **100 ft (30.48 m) Four-section Boom** – The longest in its size range. The longer boom allows the operator to perform more lifts without the use of a jib, reducing setup time and improving efficiency.
- **Overload Protection** – All National cranes are equipped with overload protection:
  - Load Moment Indicator (LMI) required on all machines equipped with jibs or personnel baskets.
  - LMI or Hydraulic Capacity Alert System (HCA) required with ordering machine without jib or personnel basket.
- **Internal Anti-two-block Wire** – The patent-pending design, standard on the 800D, routes the wire through the inside of the boom. No more snagging the wire on obstructions.
- **Easy Glide Wear Pads** – Reduce the conditions that cause boom chatter and vibration. The net result is smoother crane operation.
- **Adjustable Swing Speed** – Standard on the 800D. A control knob located on the swing motor brake release valve can be easily adjusted to the crane operator's swing speed preference.
- **Electronic versions of manuals available through Manitowoc Crane CARE.**
- **Heavier Duty Torsion Box** – The stronger standard torsion box improves rigidity, reduces truck frame flex and reduces the need for counterweight.
- **Speedy-Reeve Boom Tip and Sheave Blocks** – These standard features simplify rigging changes. Load line wedge socket removal not required for reeving of multi-part line options.
- **Pre-painted Components** – Painting crane components before assembly reduces the possibility of rust, improves serviceability and enhances the appearance of the machine.
- **Improved Serviceability and Reliability** –
  - Sheave bearings on the boom extend and retract cables can be greased through access holes in the boom side plates.
  - The number of internal boom parts has been reduced, facilitating rebuilding the machine.
- **New State-of-the-Art Control Valve** – Provides smoother operation. The new design eliminates parts, reducing repair costs and improving the machine's serviceability.
- **National Crane Is the Market Leader** – National Crane is number one in the production of commercial truck-mounted boom trucks. National Crane has the resources, programs and people to provide our customers with reliable products.
- **National Crane has the boom truck industry's leading test program** – Structural parts of the crane have been cycle tested up to 60,000 cycles at full capacity. In addition to cycle testing, each model has been subjected to intensive strain gauge testing that measures metal deformation as small as one one-millionth of an inch. The net result is that any weak areas are caught in test, not on job sites where costly downtime occurs.
- Parts are available for all National Crane machines for the life of the crane.
- National Crane has a formalized quality program and is ISO 9001 certified.

- 23 USt (20.87 t) maximum capacity
- 152 ft (46.32 m) maximum vertical reach\*
- 109 ft (33.22 m) maximum vertical hydraulic reach\*
- Load Moment Indicator System (LMI) or Hydraulic Capacity Alert System (HCA)
- Proportional boom extension
- High performance planetary winch
- Heavy-duty triple pump hydraulics
- \* Maximum vertical reach is ground-level to boom tip height at maximum extension and angle with outriggers/stabilizers fully extended.

800D

# mounting configurations

The configurations are based on the Series 800D with an 85% stability factor. The complete unit must be installed in accordance with factory requirements and a test performed to determine actual stability and counterweight requirements since individual truck chassis vary. Trucks with a frame height in excess of 42 inches (107 cm) after mounting will have a final mounted unit height more than 13' 6" (411.5 cm). Chassis that do not meet these minimum stability weights may require counterweight.

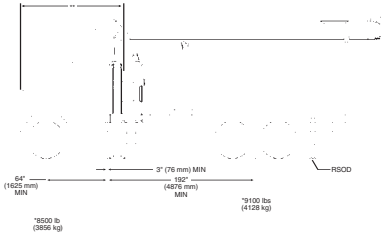

## Configuration 1 – 8100D

Working area	180°
Gross Axle Weight Rating Front	16,000 lb (7257 kg)
Gross Axle Weight Rating Rear	34,000 lb (15 422 kg)
Gross Vehicle Weight Rating	50,000 lb (22 679 kg)
Wheelbase	256 in (650 cm)
Cab to Axle/trunnion (CA/CT)	192 in (488 cm)
Frame Section Modulus (SM) under crane: 110,000 PSI (758 MPa)	15.9 in <sup>3</sup> (260.6 cm <sup>3</sup> )
Frame Section Modulus (SM) over rear stabilizers: 110,000 PSI (758 MPa)	13.0 in <sup>3</sup> (213.0 cm <sup>3</sup> )
Stability Weight, Front	8,500 lb (3856 kg) minimum*
Stability Weight, Rear	9,100 lb (4128 kg) minimum*
Estimated Average Final Weight	40,800 lb (18 507 kg)

This configuration allows the installation of the Series 8100D on a chassis by using the subbase for a 22-ft. (6.71-m) bed.

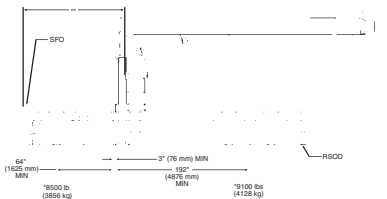

## Configuration 2 – 8100D (add SFO for 360° stability)

Working area	360°
Gross Axle Weight Rating Front	16,000 lb (7257 kg)
Gross Axle Weight Rating Rear	34,000 lb (15 422 kg)
Gross Vehicle Weight Rating	50,000 lb (22 679 kg)
Wheelbase	256 in (650 cm)
Cab to Axle/trunnion (CA/CT)	192 in (488 cm)
Frame Section Modulus (SM) under crane: 110,000 PSI (758 MPa)	20.0 in <sup>3</sup> (327.7 cm <sup>3</sup> )
Frame Section Modulus (SM) over rear stabilizers: 110,000 PSI (758 MPa)	13.0 in <sup>3</sup> (213.0 cm <sup>3</sup> )
Stability Weight, Front	8,500 lb (3856 kg) minimum*
Stability Weight, Rear	9,100 lb (4128 kg) minimum*
Estimated Average Final Weight	41,200 lb (18 688 kg)

This mount requires front stabilizer for full capacity 360° around the truck. Front stabilizer gives the machine a solid base. This configuration requires a 22-ft (6.71-m) bed for rear overhang, and extended front frame rails for SFO mounting. NOTE: Chassis will require extended front frame rails for SFO mounting.

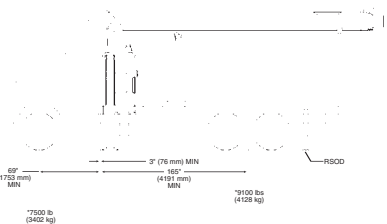

## Configuration 3 – All boom lengths, other than 8100D

Working area	180°
Gross Axle Weight Rating Front	16,000 lb (7257 kg)
Gross Axle Weight Rating Rear	34,000 lb (15 422 kg)
Gross Vehicle Weight Rating	50,000 lb (22 679 kg)
Wheelbase	234 in (594 cm)
Cab to Axle/trunnion (CA/CT)	165 in (419 cm)
Frame Section Modulus (SM) under crane w/110,000 PSI (758 MPa)	15.9 in <sup>3</sup> (260.6 cm <sup>3</sup> )
Frame Section Modulus (SM) over rear stabilizers: 110,000 PSI (758 MPa)	13.0 in <sup>3</sup> (213.0 cm <sup>3</sup> )
Stability Weight, Front	7,500 lb (3402 kg) minimum*
Stability Weight, Rear	9,100 lb (4128 kg) minimum*
Estimated Average Final Weight (890D)	38,800 lb (17 600 kg)**

This configuration allows the installation of the Series 800D on a chassis with a subbase and bed combination which best fits the boom length. Depending on the boom length, the bed can be 18', 20' or 22'. Not all bed lengths can be used with each boom due to rear overhang limits.

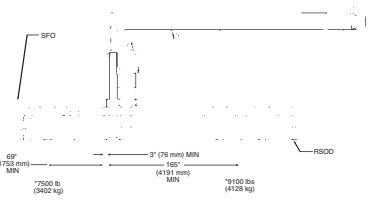

## Configuration 4 – All boom lengths, other than 8100D

Working area	360°
Gross Axle Weight Rating Front	16,000 lb (7257 kg)
Gross Axle Weight Rating Rear	34,000 lb (15 422 kg)
Gross Vehicle Weight Rating	50,000 lb (22 679 kg)
Wheelbase	234 in (594 cm)
Cab to Axle/trunnion (CA/CT)	165 in (419 cm)
Frame Section Modulus (SM) under crane w/110,000 PSI (758 MPa)	20 in <sup>3</sup> (327.7 cm <sup>3</sup> )
Frame Section Modulus (SM) over rear stabilizers: 110,000 PSI (758 MPa)	13 in <sup>3</sup> (213.0 cm <sup>3</sup> )
Stability Weight, Front	7,500 lb (3402 kg) minimum*
Stability Weight, Rear	9,100 lb (4128 kg) minimum*
Estimated Average Final Weight (890D)	39,200 lb (17 780 kg)

This mount requires front stabilizer for full capacity 360° around the truck. Front stabilizer gives the machine a solid base. Bed length and subbase combinations must match boom length to limit rear overhang. Extended front frame rails required for SFO mounting. NOTE: Chassis will require extended front frame rails for SFO mounting.

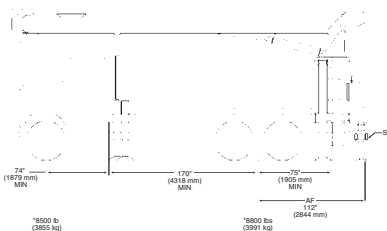

## Configuration 5 – Rear Mount (all boom lengths)

Working area	360°
Gross Axle Weight Rating Front	16,000 lb (7257 kg)
Gross Axle Weight Rating Rear	40,000 lb (18 143 kg)
Gross Vehicle Weight Rating	56,000 lb (25 401 kg)
Wheelbase	244 in (620 cm)
Cab to Axle/trunnion (CA/CT)	170 in (432 cm)
Frame Section Modulus (SM) under crane: 110,000 PSI (758 MPa)	15.9 in <sup>3</sup> (260.6 cm <sup>3</sup> )
Stability Weight, Front	8,500 lb (3856 kg) minimum*
Stability Weight, Rear	8,800 lb (3991 kg) minimum*
Estimated Average Final Weight (8100D)	43,000 lb (19 504 kg)

This configuration allows the rear-mount installation of the Series 800D. This configuration is 360° stable and allows the effective use of close working area to lift the heavier capacity loads. Maximum bed length is 16' (4.87 m). Requires single rear outrigger.

### Notes:

- Gross Vehicle Weight rating (GVWR) is dependent on all components of the vehicle (axles, tires, springs, frame, etc.) meeting manufacturers' recommendations; always specify GVWR when purchasing trucks
- Diesel engines require a variable speed governor and energize-to-run fuel solenoid for smooth crane operation; electronic fuel injection requires EET engine remote throttle

- All mounting data is based on a National Series 800D with an 85 percent stability factor
- The complete unit must be installed in accordance with factory requirements, and a test performed to determine actual stability and counterweight requirements per SAE J765; contact the factory for details
- Transmission neutral safety interlock switch is required with optional remote control

\*Estimated axle scale weights prior to installation of crane, stabilizers and subbase for 85% stability.

\*\*If the distance from the front bumper (SFO) to center of rotation exceeds 144 inches (366 cm), the 40-ft (12.19 m) overall truck length restriction will be exceeded. Overall length restrictions vary from state to state. In some states it is legal to be more than 40 ft (12.18 m) in length, and some states allow overlength permits.

3

800D

# specifications

## Boom and Jib Combinations Data

Available in five basic models.

4

**Model 851D** – Equipped with a 21 ft. to 51 ft. (6.4-15.5 m) three-section boom. Maximum tip height is 62 ft. (18.9 m).



**Model 860D** – Equipped with a 24 ft. to 60 ft. (7.31-18.28 m) three-section boom. Maximum tip height is 71 ft. (21.64 m).



**Model 880D** – Equipped with a 24 ft. 6 in. to 80 ft. (7.46-24.38 m) four-section boom. This model can be equipped with a 22-39 ft. (6.70-11.88 m) two-section jib. Maximum tip height w/39 ft. (11.88 m) jib is 128 ft. (39.01 m).

24'6"-80' (7.46-24.38 m) four-section boom.



24'6"-80' (7.46-24.38 m) four-section boom. **8FJ39M** 22-39 ft. (6.70-11.88 m) two-section jib



**Model 890D** – Equipped with a 27 ft. to 90 ft. (8.23-27.43 m) four-section boom. This model can be equipped with a 25-44 ft. (7.62-13.41 m) two-section jib. Maximum tip height w/44 ft. (13.41 m) jib is 143 ft. (43.58 m).

27'-90' (8.23-27.43 m) four-section boom.



27'-90' (8.23-27.43 m) four-section boom. **8FJ44M** 25-44 ft. (7.62-13.41 m) two-section jib



**Model 8100D** – Equipped with a 29 ft. 6 in. to 100 ft. (8.99-30.48 m) four-section boom. This model can be equipped with a 25-44 ft. (7.62-13.41 m) two-section jib. Maximum tip height w/44 ft. (13.41 m) jib is 152 ft. (46.32 m).

29'6" - 100' (8.99-30.48 m) four-section boom.



29'6" - 100' (8.99-30.48 m) four-section boom. **8FJ44M** 25-44 ft. (7.62-13.41 m) two-section jib



**Note:** Maximum tip is measured with outriggers/stabilizers fully extended.

## 800D Winch Data

### 800D Winch Data

- All winch pulls and speeds in this chart are shown on the **fourth** layer
- Winch line pulls would increase on the first, second and third layers
- Winch line speed would decrease on the first, second and third layers
- Winch line pulls may be limited by the winch capacity or the ANSI 5 to 1 cable safety factor
- Hook blocks are rated at maximum capacity for the block. **Do not exceed rated cable pull with any block.**

Winch	Cable Supplied	Average Breaking Strength	1 Part Line	2 Part Line	3 Part Line	4 Part Line	5 Part Line	6 Part Line
			Lift and Speed	Lift and Speed	Lift and Speed	Lift and Speed	Lift and Speed	Lift and Speed
Standard Planetary Winch	9/16" Diameter Rotation Resistant	38,600 lb (17,463 kg)	7,700 lb (3492 kg) 147 fpm (45 m/min)	15,400 lb (6,985 kg) 73 fpm (22 m/m)	23,100 lb (10,477 kg) 49 fpm (15 m/m)	30,800 lb (13,970 kg) 38 fpm (11 m/m)	38,500 lb (17,163 kg) 29 fpm (9 m/m)	46,000 lb (20,865 kg) 25 fpm (8 m/m)
With "Burst-of-Speed"	Same as corresponding cable data shown above		3,000 lb (1360 kg) 206 fpm (62 m/m)	6,000 lb (2721kg) 103 fpm (31 m/m)	9,000 lb (4082 kg) 68 fpm (20 m/m)	12,000 lb (5443 kg) 51 fpm (15 m/m)	15,000 lb (6803 kg) 41 fpm (12 m/m)	18,000 lb (8164 kg) 34 fpm (10 m/m)

Block Type	Rating	Weight
Downhaul Weight.....	3.85 USt (3.49 t).....	150 lb (68 kg)
1 Sheave Block.....	11.55 USt (10.48 t).....	305 lb (138 kg)
2 Sheave Block.....	19.25 USt (17.46 t).....	355 lb (161 kg)
3 Sheave Block.....	30.00 USt (27.21 t).....	575 lb (261 kg)

Winch	Bare Drum Pull	Allowable Cable Pull
With standard rotation resistant rope.....	10,200 lb (4627 kg).....	7,700 lb (3493 kg)

800D

# capacities

## Load Rating Chart: Series 8100D (30.48 m) Boom with 44 ft (13.41 m) Jib

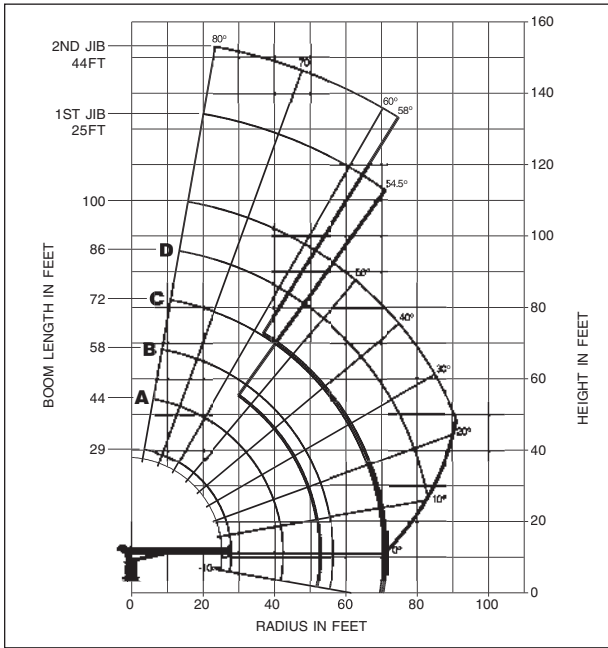

### CAUTION:

- Do not operate crane booms, jib extensions, any accessories or loads within 10 ft (3m) of live power lines or other conductors of electricity.
- Jib and boom capacities shown are maximum for each section.
- Do not exceed capacities at reduced radii
- Load ratings shown on the load rating charts are maximum allowable loads with the outriggers properly extended on a firm, level surface and the crane leveled and mounted on a factory recommended truck.
- Always level the crane with the level indicator located on the crane.
- The operator must reduce load to allow for factors such as wind, ground conditions, operating speeds and their effects on freely suspended loads.
- Overloading this crane may cause structural collapse or instability.
- Weights on any accessories attached to the boom or loadline must be deducted from the load chart capacities.
- Do not exceed jib capabilities at any reduced boom lengths.
- Do not deadhead lineblock against boom tip when extending boom or winching up.
- Keep at least three wraps of loadline on drum at all times.
- Use only specified cable with this machine.

5

### SERIES 8100D (30.48 M) WITH 44 ft (13.41 M) JIB

### NOTE:

- Operate with jib by radius when main boom is fully extended. If necessary increase boom angle to maintain loaded radius.
- Operate with jib by boom angle when main boom is not fully extended. Do not exceed rated jib capacities at any reduced boom lengths.

### LMI OPERATING CODE

OPERATING MODE	
01	Main Boom - No Jib Stowed
02	Main Boom - Jib Stowed
03	25 ft Tele Jib
04	44 ft Tele Jib
11	Man Basket On Main Boom
12	Man Basket On 25 ft Tele Jib
13	Man Basket On 44 ft Tele Jib

## Load Rating: Series 8100D (30.48 m) Boom with 44 ft (13.41 m) Jib

LOAD RADIUS (FEET)	LOADED BOOM ANGLE	29 ft BOOM (lb)	LOADED BOOM ANGLE	A 44 ft BOOM (lb)	LOADED BOOM ANGLE	B 58 ft BOOM (lb)	LOADED BOOM ANGLE	C 72 ft BOOM (lb)	LOADED BOOM ANGLE	D 86 ft BOOM (lb)	LOADED BOOM ANGLE	100 ft BOOM (lb)	LOAD RADIUS (FEET)	LOADED BOOM ANGLE	25 ft JIB (lb)	LOADED BOOM ANGLE	44 ft JIB (lb)
5	79	46,000											30	78	3,900	80	2,750
8	72.5	30,700	79	27,900									35	75.5	3,400	78	2,500
10	68	25,500	76	23,200									40	73	2,800	76	2,250
12	63.5	21,800	73.5	19,700	78	18,050							45	70.5	2,350	74	2,000
14	59	19,000	70.5	17,200	76	15,750	79.5	14,350					50	68	1,850	72	1,850
16	54	16,700	68	15,200	74	13,850	77.5	12,650					55	65	1,500	70	1,600
20	43	13,400	61	12,200	69.5	11,250	74.5	10,350	77.5	9,550	80	7,450	60	62.5	1,300	67.5	1,350
25	25	9,700	54	9,700	64	8,950	70	8,250	74	7,650	77	7,100	65	60	1,100	65	1,050
30			45	7,900	58.5	7,350	66	6,650	70.5	6,150	74	5,850	70	57	750	63	950
35			35	6,300	53	6,100	61.5	5,600	67	5,200	71	4,900	75	54.5	600	60.5	800
40			20	4,600	46	5,100	56.5	4,750	63	4,400	67.5	4,250	80			58	600
45					38	4,250	51.5	4,050	59.5	3,800	64.5	3,650					
50					28.5	3,400	46	3,450	55	3,250	61	3,150					
55					14	2,200	40	2,900	51	2,800	57.5	2,650					
60							33	2,350	46.5	2,400	54	2,300					
65							24	1,800	41	2,000	50	1,850					
70							6.5	700	35.5	1,600	46	1,650					
75									29	1,250	42	1,350					
80									20	800	37	1,050					
85											32	800					
90											25	500					
	0	5,100	0	2,300	0	950											

### LOADLINE EQUIPMENT DEDUCT ( lb )

Downhaul weight	_____	150
One sheave block	_____	305
Two sheave block	_____	355
Three sheave block	_____	575

Shaded areas are structurally limited capacities.

THIS CHART IS ONLY A GUIDE AND SHOULD NOT BE USED TO OPERATE THE CRANE. The individual crane's load chart, operating instructions and other instructional plates must be read and understood prior to operating the crane.

800D

# capacities

## Load Rating Chart: Series 8100D (30.48 m) Boom with No Jib

6

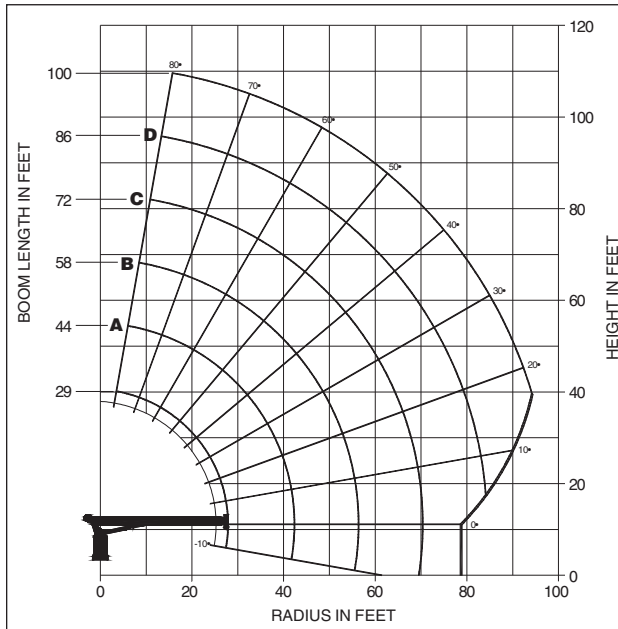

### CAUTION:

- Do not operate crane booms, jib extensions, any accessories or loads within 10 ft (3m) of live power lines or other conductors of electricity.
- Jib and boom capacities shown are maximum for each section.
- Do not exceed capacities at reduced radii
- Load ratings shown on the load rating charts are maximum allowable loads with the outriggers properly extended on a firm, level surface and the crane leveled and mounted on a factory recommended truck.
- Always level the crane with the level indicator located on the crane.
- The operator must reduce load to allow for factors such as wind, ground conditions, operating speeds and their effects on freely suspended loads.
- Overloading this crane may cause structural collapse or instability.
- Weights on any accessories attached to the boom or loadline must be deducted from the load chart capacities.
- Do not exceed jib capabilities at any reduced boom lengths.
- Do not deadhead lineblock against boom tip when extending boom or winching up.
- Keep at least three wraps of loadline on drum at all times.
- Use only specified cable with this machine.

**SERIES 8100D  
(30.48m) /  
NO JIB**

### LOADLINE EQUIPMENT DEDUCT (lb)

Downhaul weight	_____	150
One sheave block	_____	305
Two sheave block	_____	355
Three sheave block	_____	575

## Load Rating Chart: Series 8100D (30.48 m) Boom with No Jib

LOAD RADIUS (FEET)	LOADED BOOM ANGLE	29 ft BOOM (lb)	LOADED BOOM ANGLE	A 44 ft BOOM (lb)	LOADED BOOM ANGLE	B 58 ft BOOM (lb)	LOADED BOOM ANGLE	C 72 ft BOOM (lb)	LOADED BOOM ANGLE	D 86 ft BOOM (lb)	LOADED BOOM ANGLE	100 ft BOOM (lb)
5	79	46,000										
8	72.5	31,500	79	28,500								
10	68	26,300	76	23,800								
12	63.5	22,600	73.5	20,300	78	18,500						
14	59	19,800	70.5	17,800	76	16,200	79.5	14,700				
16	54	17,500	68	15,800	74	14,300	77.5	13,000				
20	43	14,200	61	12,800	69.5	11,700	74.5	10,700	77.5	9,850		
25	25	10,500	54	10,300	64	9,400	70	8,600	74	7,950	77	7,350
30			45	8,500	58.5	7,800	66	7,000	70.5	6,450	74	6,100
35			35	6,900	53	6,550	61.5	5,950	67	5,500	71	5,150
40			20	5,200	46	5,550	56.5	5,100	63	4,700	67.5	4,500
45					38	4,700	51.5	4,400	59.5	4,100	64.5	3,900
50					28.5	3,850	46	3,800	55	3,550	61	3,400
55					14	2,650	40	3,250	51	3,100	57.5	2,900
60							33	2,700	46.5	2,700	54	2,550
65							24	2,150	41	2,300	50	2,100
70							6.5	1,050	35.5	1,900	46	1,900
75									29	1,550	42	1,600
80									20	1,100	37	1,300
85											32	1,050
90											25	750
	0	5,900	0	2,900	0	1,400	0	500				

Shaded areas are structurally limited capacities.

THIS CHART IS ONLY A GUIDE AND SHOULD NOT BE USED TO OPERATE THE CRANE. The individual crane's load chart, operating instructions and other instructional plates must be read and understood prior to operating the crane.

**800D**

# capacities

7

## Load Rating Chart: Series 851D (15.54 m) Boom with No Jib

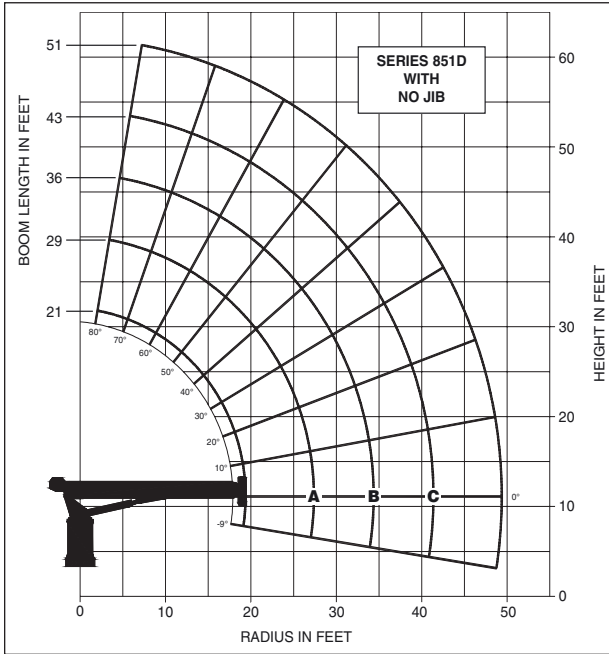

### CAUTION:

- Do not operate crane booms, jib extensions, any accessories or loads within 10 ft (3m) of live power lines or other conductors of electricity.
- Jib and boom capacities shown are maximum for each section.
- Do not exceed capacities at reduced radii
- Load ratings shown on the load rating charts are maximum allowable loads with the outriggers properly extended on a firm, level surface and the crane leveled and mounted on a factory recommended truck.
- Always level the crane with the level indicator located on the crane.
- The operator must reduce load to allow for factors such as wind, ground conditions, operating speeds and their effects on freely suspended loads.
- Overloading this crane may cause structural collapse or instability.
- Weights on any accessories attached to the boom or loadline must be deducted from the load chart capacities.
- Do not exceed jib capabilities at any reduced boom lengths.
- Do not deadhead lineblock against boom tip when extending boom or winching up.
- Keep at least three wraps of loadline on drum at all times.
- Use only specified cable with this machine.

**SERIES 851D  
(15.54 M) /  
NO JIB**

### LOADLINE EQUIPMENT DEDUCT ( lb )

Downhaul weight \_\_\_\_\_ 150 lb (68 kg)  
One sheave block \_\_\_\_\_ 305 lb (138 kg)  
Two sheave block \_\_\_\_\_ 355 lb (161 kg)  
Three sheave block \_\_\_\_\_ 575 lb (261 kg)

## Load Rating Chart: Series 851D (15.54 m) Boom with No Jib

LOAD RADIUS (FEET)	LOADED BOOM ANGLE	21 ft BOOM (lb)	LOADED BOOM ANGLE	A 29 ft BOOM (lb)	LOADED BOOM ANGLE	B 36 ft BOOM (lb)	LOADED BOOM ANGLE	C 43 ft BOOM (lb)	LOADED BOOM ANGLE	51 ft BOOM (lb)
5	73.5	46,000								
8	64	32,800	72	30,500	76	29,000				
10	57.5	27,800	67.5	26,200	72.5	25,100	76	23,800	78	22,500
12	50.5	24,500	63	23,200	69	22,100	73	21,100	76	21,000
14	42.5	21,400	58.5	20,500	65.5	20,000	70	18,800	73.5	18,000
16	33	18,400	53.5	18,300	62	17,500	67	16,600	71	16,500
20			42.5	15,500	54	15,100	61	14,000	66	13,500
25			23	11,400	43	12,500	53	12,000	59.5	11,000
30					29	9,300	43.5	10,000	53	9,600
35							33	7,800	46	8,500
40							16	6,000	37	6,800
45									25	5,800
	0	11,200	0	7,200	0	5,400	0	4,200	0	3,200

Shaded areas are structurally limited capacities.

THIS CHART IS ONLY A GUIDE AND SHOULD NOT BE USED TO OPERATE THE CRANE. The individual crane's load chart, operating instructions and other instructional plates must be read and understood prior to operating the crane.

800D

# capacities

## Load Rating Chart: Series 860D (18.28 m) Boom with No Jib

8

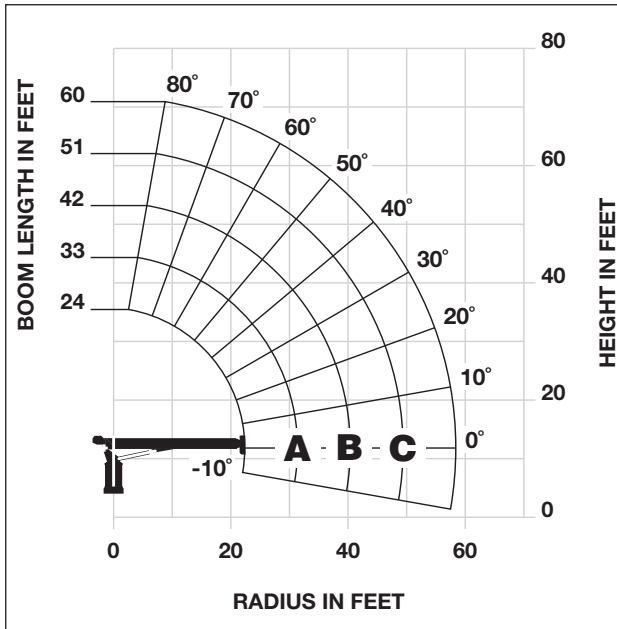

**CAUTION:**

- Do not operate crane booms, jib extensions, any accessories or loads within 10 ft (3m) of live power lines or other conductors of electricity.
- Jib and boom capacities shown are maximum for each section.
- Do not exceed capacities at reduced radii
- Load ratings shown on the load rating charts are maximum allowable loads with the outriggers properly extended on a firm, level surface and the crane leveled and mounted on a factory recommended truck.
- Always level the crane with the level indicator located on the crane.
- The operator must reduce load to allow for factors such as wind, ground conditions, operating speeds and their effects on freely suspended loads.
- Overloading this crane may cause structural collapse or instability.
- Weights on any accessories attached to the boom or loadline must be deducted from the load chart capacities.
- Do not exceed jib capabilities at any reduced boom lengths.
- Do not deadhead lineblock against boom tip when extending boom or winching up.
- Keep at least three wraps of loadline on drum at all times.
- Use only specified cable with this machine.

**SERIES 860D /  
NO JIB**

**LOADLINE EQUIPMENT  
DEDUCT (lb)**

Downhaul weight	_____	150 lb (68 kg)
One sheave block	_____	305 lb (138 kg)
Two sheave block	_____	355 lb (161 kg)
Three sheave block	_____	575 lb (261 kg)

## Load Rating Chart: Series 860D (18.28 m) Boom with No Jib

LOADED RADIUS (ft)	LOADED BOOM ANGLE (deg)	24 ft BOOM (lb)	LOADED BOOM ANGLE (deg)	A 33 ft BOOM (lb)	LOADED BOOM ANGLE (deg)	B 42 ft BOOM (lb)	LOADED BOOM ANGLE (deg)	C 51 ft BOOM (lb)	LOADED BOOM ANGLE (deg)	60 ft BOOM (lb)
5	75.5	39,200								
8	67.5	28,100								
10	62	23,800	70.5	22,400	75	21,500	78	20,800		
12	56.5	20,700	66.5	19,350	72.5	18,500	76	17,900	78	17,500
14	50	18,200	62.5	17,100	69.5	16,250	73.5	15,700	76	15,300
16	43	16,150	58.5	15,300	66.5	14,500	71	13,950	74	13,550
20	25	12,350	49.5	12,550	60	11,950	66	11,450	70	11,100
25			36.5	9,950	51.5	9,700	59.5	9,300	65	9,000
30			18	7,300	41.5	8,000	52.5	7,800	59.5	7,500
35					30.5	6,550	45.5	6,600	54	6,400
40							36.5	5,600	47.5	5,500
45							25	4,550	40.5	4,750
50									32	4,000
55									20	3,150
60										
65	0	7,700	0	4,850	0	3,350	0	2,150	0	1,650

Shaded areas are structurally limited capacities.

THIS CHART IS ONLY A GUIDE AND SHOULD NOT BE USED TO OPERATE THE CRANE. The individual crane's load chart, operating instructions and other instructional plates must be read and understood prior to operating the crane.

**800D**



# capacities

## Load Rating Chart: Series 880D (24.38 m) Boom with 44 ft (13.41 m) Jib

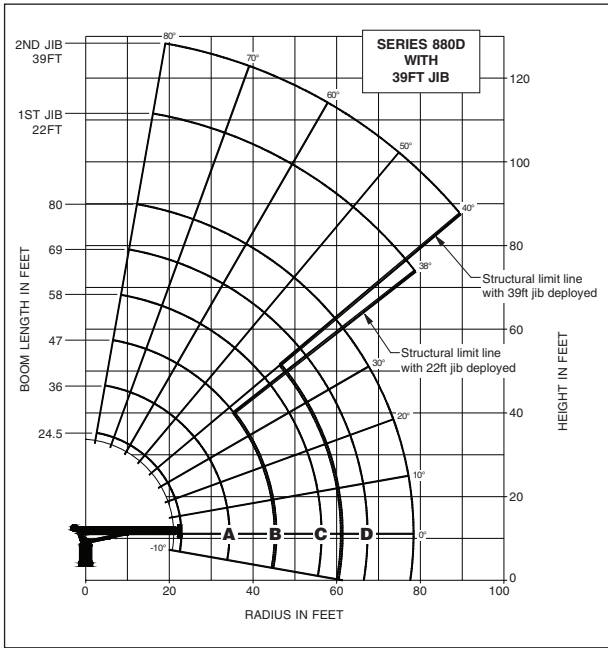

### CAUTION:

- Do not operate crane booms, jib extensions, any accessories or loads within 10 ft (3m) of live power lines or other conductors of electricity.
- Jib and boom capacities shown are maximum for each section.
- Do not exceed capacities at reduced radii
- Load ratings shown on the load rating charts are maximum allowable loads with the outriggers properly extended on a firm, level surface and the crane leveled and mounted on a factory recommended truck.
- Always level the crane with the level indicator located on the crane.
- The operator must reduce load to allow for factors such as wind, ground conditions, operating speeds and their effects on freely suspended loads.
- Overloading this crane may cause structural collapse or instability.
- Weights on any accessories attached to the boom or loadline must be deducted from the load chart capacities.
- Do not exceed jib capabilities at any reduced boom lengths.
- Do not deadhead lineblock against boom tip when extending boom or winching up.
- Keep at least three wraps of loadline on drum at all times.
- Use only specified cable with this machine.

9

### SERIES 880D BOOM WITH 44 ft (13.41 M) JIB

### NOTE:

- Operate with jib by radius when main boom is fully extended. If necessary increase boom angle to maintain loaded radius.
- Operate with jib by boom angle when main boom is not fully extended. Do not exceed rated jib capacities at any reduced boom lengths.

### LOADLINE EQUIPMENT DEDUCT ( lb )

Downhaul weight	150 lb (68 kg)
One sheave block	305 lb (138 kg)
Two sheave block	355 lb (161 kg)
Three sheave block	575 lb (261 kg)

## Load Rating Chart: Series 880D (24.38 m) Boom with 44 ft (13.41 m) Jib

LOAD RADIUS (FEET)	LOADED BOOM ANGLE	24.5FT BOOM (lb)	LOADED BOOM ANGLE	A 36FT BOOM (lb)	LOADED BOOM ANGLE	B 47FT BOOM (lb)	LOADED BOOM ANGLE	C 58FT BOOM (lb)	LOADED BOOM ANGLE	69FT BOOM (lb)	LOADED BOOM ANGLE	80FT BOOM (lb)	LOAD RADIUS (FEET)	LOADED BOOM ANGLE	22FT JIB (lb)	LOADED BOOM ANGLE	39FT JIB (lb)
5	76	46,000											20	79	6,000		
8	68.5	32,300											25	76	5,150	78.5	4,400
10	63	27,300	73	24,300	78	23,200							30	73	4,500	76.1	4,200
12	57	23,500	69.5	21,500	75	19,900	78	18,400					35	70	3,850	74	3,900
14	51	20,500	65.5	18,800	72	17,400	76	16,200	79	15,200			40	67	3,350	71	3,350
16	44.5	18,100	62	16,800	69.5	15,500	74	14,400	77	13,400	79	13,000	45	64	2,850	68.5	2,850
20	27.5	13,800	54.5	13,700	64	12,700	67	11,800	73.5	11,000	76	10,700	50	60.5	2,450	65.5	2,450
25			43	10,900	57	10,300	64	9,550	69	8,900	72	8,700	55	57	2,150	63	2,150
30			28.5	8,500	49	8,500	58.5	7,950	65	7,350	68.5	7,050	60	54	1,850	60	1,850
35					40.5	7,000	53	6,650	60	6,250	64.5	6,050	65	50	1,600	57	1,600
40					29.5	5,700	46	5,700	55	5,400	60.5	5,200	70	46	1,350	54	1,350
45							38.5	4,800	49.5	4,650	56.5	4,500	75	42	1,200	50.5	1,200
50							29	4,000	43.5	4,050	51.5	3,950	80	38	1,000	47.5	1,000
55							14	2,800	36.5	3,450	47	3,450	85			43.5	800
60									28.5	2,850	41.5	3,000	90			40	600
65									16.5	2,050	35.5	2,550					
70											28	2,100					
75											18	1,500					
	0	7,900	0	4,300	0	2,550	0	1,550	0	800							
ADD TO CAPACITIES WHEN NO JIB STOWED (lb)		700		500		400		300		250		200					

Shaded areas are structurally limited capacities.

THIS CHART IS ONLY A GUIDE AND SHOULD NOT BE USED TO OPERATE THE CRANE. The individual crane's load chart, operating instructions and other instructional plates must be read and understood prior to operating the crane.

800D

# capacities

10

## Load Rating Chart: Series 880D (24.38 m) Boom with No Jib

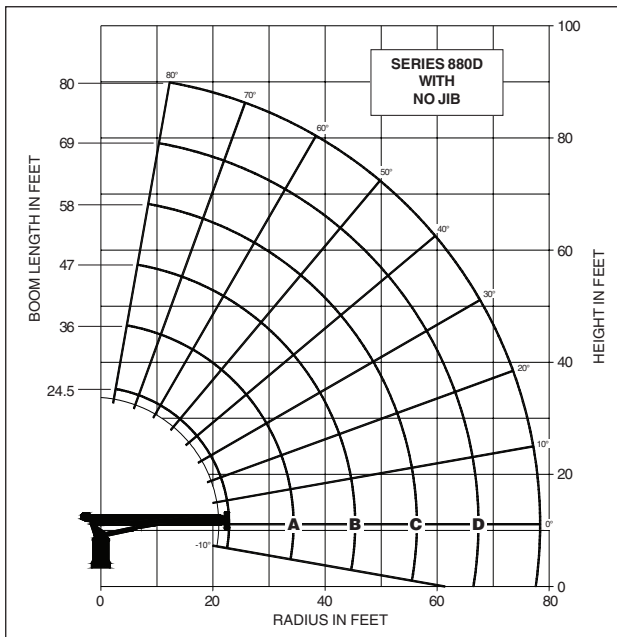

### CAUTION:

- Do not operate crane booms, jib extensions, any accessories or loads within 10 ft (3m) of live power lines or other conductors of electricity.
- Jib and boom capacities shown are maximum for each section.
- Do not exceed capacities at reduced radii
- Load ratings shown on the load rating charts are maximum allowable loads with the outriggers properly extended on a firm, level surface and the crane leveled and mounted on a factory recommended truck.
- Always level the crane with the level indicator located on the crane.
- The operator must reduce load to allow for factors such as wind, ground conditions, operating speeds and their effects on freely suspended loads.
- Overloading this crane may cause structural collapse or instability.
- Weights on any accessories attached to the boom or loadline must be deducted from the load chart capacities.
- Do not exceed jib capabilities at any reduced boom lengths.
- Do not deadhead lineblock against boom tip when extending boom or winching up.
- Keep at least three wraps of loadline on drum at all times.
- Use only specified cable with this machine.

**SERIES 880D  
(24.38 M) BOOM /  
NO JIB**

LOADLINE EQUIPMENT DEDUCT (lb)	
Downhaul weight	150 lb (68 kg)
One sheave block	305 lb (138 kg)
Two sheave block	355 lb (161 kg)
Three sheave block	575 lb (261 kg)

## Load Rating Chart: Series 880D (24.38 m) Boom with No Jib

LOAD RADIUS (FEET)	LOADED BOOM ANGLE	24.5 ft BOOM (lb)	LOADED BOOM ANGLE	A 36 ft BOOM (lb)	LOADED BOOM ANGLE	B 47 ft BOOM (lb)	LOADED BOOM ANGLE	C 58 ft BOOM (lb)	LOADED BOOM ANGLE	D 69 ft BOOM (lb)	LOADED BOOM ANGLE	80 ft BOOM (lb)
5	76	46,000										
8	68.5	33,000										
10	63	28,000	73	24,800	78	23,600						
12	57	24,200	69.5	22,000	75	20,300	78	18,700				
14	51	21,200	65.5	19,300	72	17,800	76	16,500	79	15,500		
16	44.5	18,800	62	17,300	69.5	15,900	74	14,700	77	13,700	79	13,200
20	27.5	14,500	54.5	14,200	64	13,100	67	12,100	73.5	11,300	76	10,900
25			43	11,400	57	10,700	64	9,850	69	9,200	72	8,900
30			28.5	9,000	49	8,900	58.5	8,250	65	7,600	68.5	7,250
35					40.5	7,400	53	6,950	60	6,500	64.5	6,250
40					29.5	6,100	46	6,000	55	5,650	60.5	5,400
45							38.5	5,100	49.5	4,900	56.5	4,700
50							29	4,300	43.5	4,300	51.5	4,150
55							14	3,100	36.5	3,700	47	3,650
60									28.5	3,100	41.5	3,200
65									16.5	2,300	35.5	2,750
70											28	2,300
75											18	1,700
	0	8,600	0	4,800	0	2,950	0	1,850	0	1,050	0	500

Shaded areas are structurally limited capacities.

THIS CHART IS ONLY A GUIDE AND SHOULD NOT BE USED TO OPERATE THE CRANE. The individual crane's load chart, operating instructions and other instructional plates must be read and understood prior to operating the crane.

800D

# capacities

## Load Rating Chart: Series 890D (27.43 m) Boom with 44 ft (13.41 m) Jib

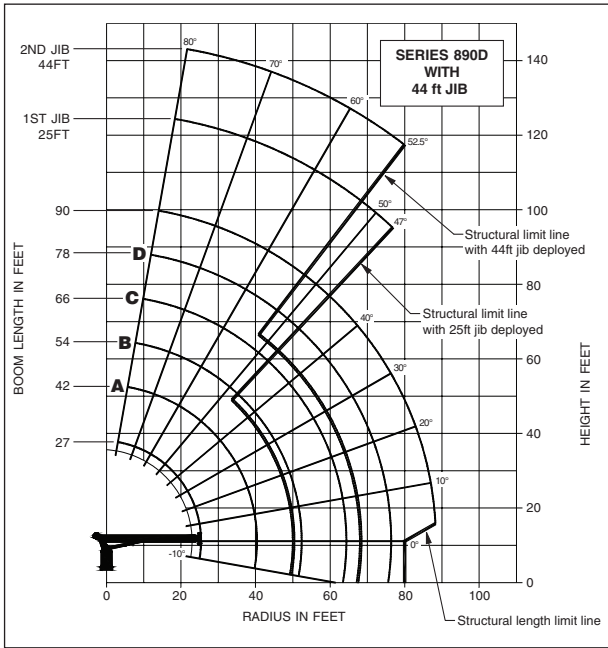

### CAUTION:

- Do not operate crane booms, jib extensions, any accessories or loads within 10 ft (3m) of live power lines or other conductors of electricity.
- Jib and boom capacities shown are maximum for each section.
- Do not exceed capacities at reduced radii
- Load ratings shown on the load rating charts are maximum allowable loads with the outriggers properly extended on a firm, level surface and the crane leveled and mounted on a factory recommended truck.
- Always level the crane with the level indicator located on the crane.
- The operator must reduce load to allow for factors such as wind, ground conditions, operating speeds and their effects on freely suspended loads.
- Overloading this crane may cause structural collapse or instability.
- Weights on any accessories attached to the boom or loadline must be deducted from the load chart capacities.
- Do not exceed jib capabilities at any reduced boom lengths.
- Do not deadhead lineblock against boom tip when extending boom or winching up.
- Keep at least three wraps of loadline on drum at all times.
- Use only specified cable with this machine.

11

### SERIES 890D BOOM WITH 44 ft (13.41 M) JIB

### NOTE:

- Operate with jib by radius when main boom is fully extended. If necessary increase boom angle to maintain loaded radius.
- Operate with jib by boom angle when main boom is not fully extended. Do not exceed rated jib capacities at any reduced boom lengths.

### LOADLINE EQUIPMENT DEDUCT ( lb )

Downhaul weight	_____	150 lb (68 kg)
One sheave block	_____	305 lb (138 kg)
Two sheave block	_____	355 lb (161 kg)
Three sheave block	_____	575 lb (261 kg)

## Load Rating Chart: Series 890D (27.43 m) Boom with 44 ft (13.41 m) Jib

LOAD RADIUS (FEET)	LOADED BOOM ANGLE	27 ft BOOM (lb)	LOADED BOOM ANGLE	A 42 ft BOOM (lb)	LOADED BOOM ANGLE	B 54 ft BOOM (lb)	LOADED BOOM ANGLE	C 66 ft BOOM (lb)	LOADED BOOM ANGLE	D 78 ft BOOM (lb)	LOADED BOOM ANGLE	90 ft BOOM (lb)	LOAD RADIUS (FEET)	LOADED BOOM ANGLE	25 ft JIB (lb)	LOADED BOOM ANGLE	44 ft JIB (lb)
5	77	46,000											30	76.5	4,800	79	3,100
8	70	32,300											35	74	4,300	77	2,900
10	65	26,700	75.5	23,400	79	21,900							40	71.5	3,650	75	2,700
12	60	22,800	72.5	20,400	77	18,700							45	68.5	3,000	73	2,500
14	54.5	19,900	69.5	17,800	75	16,400	78	15,050					50	66	2,450	71	2,300
16	49	17,500	66.5	15,800	72.5	14,400	76	13,250	79	12,300			55	63	2,000	69	2,100
20	35	13,700	60	12,700	68	11,800	72.5	10,900	76	10,000	78	9,750	60	60	1,600	66	1,800
25			51.5	10,200	62	9,500	68	8,800	72	8,150	74.5	7,850	65	57	1,300	63.5	1,500
30			42	8,300	55.5	7,950	63.5	7,100	68	6,500	71.5	6,250	70	54	1,000	61	1,250
35			31	6,550	49	6,500	58	6,050	64	5,550	68	5,300	75	50.5	750	58.5	1,050
40					41	5,450	53	5,150	60	4,950	64.5	4,500	80	47	500	55.5	850
45					32	4,500	47	4,400	55	4,100	61	3,900	85			52.5	650
50						18.5	3,300	40.5	3,700	50.5	3,550	57	3,350				
55								32.5	3,000	45.5	3,000	53	2,900				
60								22.5	2,350	39.5	2,600	49	2,500				
65										33	2,150	44	2,150				
70										25	1,650	39	1,800				
75										12	850	33.5	1,450				
80												26.5	1,100				
85												17	600				
	0	6,600	0	3,000	0	1,600	0	600									
ADD TO CAPACITIES WHEN NO JIB STOWED (lb)		800		500		400		350		300		250					

Shaded areas are structurally limited capacities.

THIS CHART IS ONLY A GUIDE AND SHOULD NOT BE USED TO OPERATE THE CRANE. The individual crane's load chart, operating instructions and other instructional plates must be read and understood prior to operating the crane.

800D

# capacities

12

## Load Rating Chart: Series 890D (27.43 m) Boom with No Jib

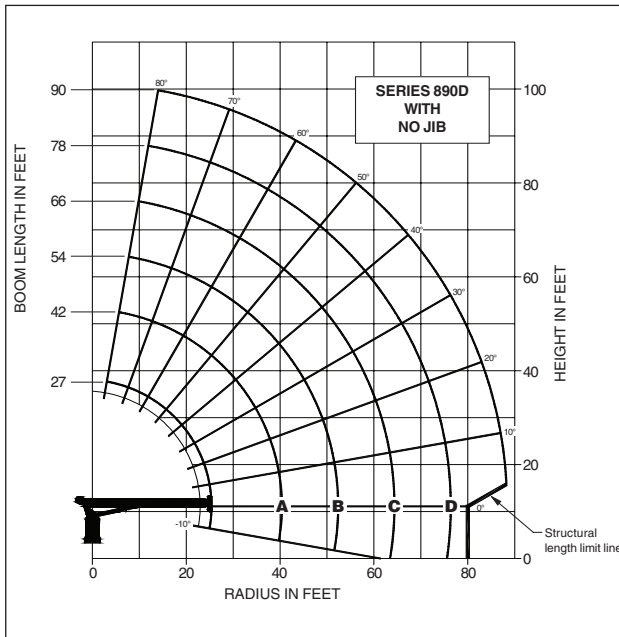

### CAUTION:

- Do not operate crane booms, jib extensions, any accessories or loads within 10 ft (3m) of live power lines or other conductors of electricity.
- Jib and boom capacities shown are maximum for each section.
- Do not exceed capacities at reduced radii
- Load ratings shown on the load rating charts are maximum allowable loads with the outriggers properly extended on a firm, level surface and the crane leveled and mounted on a factory recommended truck.
- Always level the crane with the level indicator located on the crane.
- The operator must reduce load to allow for factors such as wind, ground conditions, operating speeds and their effects on freely suspended loads.
- Overloading this crane may cause structural collapse or instability.
- Weights on any accessories attached to the boom or loadline must be deducted from the load chart capacities.
- Do not exceed jib capabilities at any reduced boom lengths.
- Do not deadhead lineblock against boom tip when extending boom or winching up.
- Keep at least three wraps of loadline on drum at all times.
- Use only specified cable with this machine.

**SERIES 890D  
(27.43 M) BOOM /  
NO JIB**

### LOADLINE EQUIPMENT DEDUCT (lb)

Downhaul weight	_____	150 lb (68 kg)
One sheave block	_____	305 lb (138 kg)
Two sheave block	_____	355 lb (161 kg)
Three sheave block	_____	575 lb (261 kg)

## Load Rating Chart: Series 890D (27.43 m) Boom with No Jib

LOAD RADIUS (FEET)	LOADED BOOM ANGLE	27 ft BOOM (lb)	LOADED BOOM ANGLE	A 42 ft BOOM (lb)	LOADED BOOM ANGLE	B 54 ft BOOM (lb)	LOADED BOOM ANGLE	C 66 ft BOOM (lb)	LOADED BOOM ANGLE	D 78 ft BOOM (lb)	LOADED BOOM ANGLE	90 ft BOOM (lb)
5	77	46,000										
8	70	33,000										
10	65	27,400	75.5	23,900	79	22,300						
12	60	23,500	72.5	20,900	77	19,100						
14	54.5	20,700	69.5	18,300	75	16,800	78	15,400				
16	49	18,300	66.5	16,300	72.5	14,800	76	13,600	79	12,600		
20	35	14,500	60	13,200	68	12,200	72.5	11,250	76	10,300	78	10,000
25			51.5	10,700	62	9,900	68	9,150	72	8,450	74.5	8,100
30			42	8,800	55.5	8,350	63.5	7,450	68	6,800	71.5	6,500
35			31	7,050	49	6,900	58	6,400	64	5,850	68	5,550
40					41	5,850	53	5,500	60	5,250	64.5	4,750
45					32	4,900	47	4,750	55	4,400	61	4,150
50					18.5	3,700	40.5	4,050	50.5	3,850	57	3,600
55							32.5	3,350	45.5	3,300	53	3,150
60							22.5	2,700	39.5	2,900	49	2,750
65									33	2,450	44	2,400
70									25	1,950	39	2,050
75									12	1,150	33.5	1,700
80											26.5	1,350
85											17	850
	0	7,400	0	3,500	0	2,000	0	950				

Shaded areas are structurally limited capacities.

THIS CHART IS ONLY A GUIDE AND SHOULD NOT BE USED TO OPERATE THE CRANE. The individual crane's load chart, operating instructions and other instructional plates must be read and understood prior to operating the crane.

800D

## **Radio Remote Controls –**

Eliminate the handling and maintenance concerns that accompany cabled remotes. Operate to a range of about 250 feet (76 m), varying with conditions.

• **NB4R**

## **One-Person Basket –**

Strong but lightweight steel basket with 300 lb (139 kg) capacity, gravity hung with swing lock and full body harness.

• **B1-S**  
• **2B1-S** (for dual locking baskets)

## **Heavy-duty Personnel Basket –**

1,200 lb. (544 kg) capacity steel basket with safety loops for four passengers. Gravity leveling 72 x 42 in (183 x 107 cm) platform. Fast attachment and secure locking systems. Load chart must show 2,300 lb (1043 kg) minimum to operate this accessory.

• **BSA-1**  
• **BSA-R1** (provides rotation)

## **Hydraulic Oil Cooler –**

Automatic, self-contained radiator system with electric fans cools oil under continuous operation.

• **OC**

## **Continuous Rotation –**

Allows rotation of turret/boom without rotation stop.

• **CR**

## **Single Front Outrigger –**

Center mount front stabilizer with 25 in vertical stroke.

• **SFO**

## **Hour Meter –**

Hour meter in truck cab to record crane operation hours.

• **HRM**

## **Bulkhead Options –**

Steel 30 in solid wall bulkhead.

• **BHSI**  
• **BHSD**

## **Steel Tool Box Options –**

**Spanish-Language Danger Decals, Control Knobs, and Operators' Manuals –**

• **SDD**  
• **SOM**

# dimensions specifications

## Dimensions Specifications

14

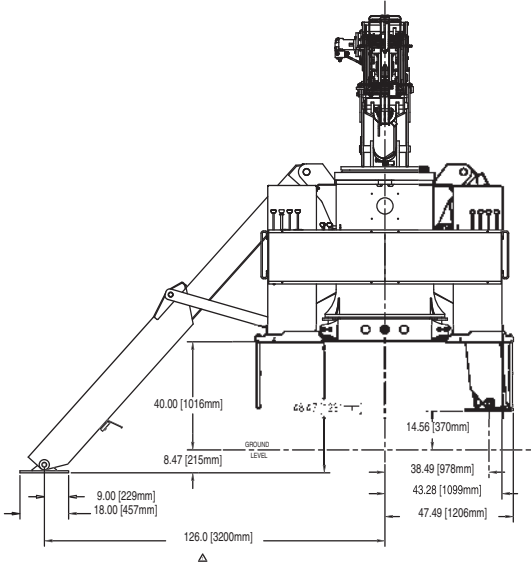

SERIES	G in (mm)	DRY WEIGHT lb (kg)	WITH OIL/WT lb (kg)
851D	28 (686)	13700 (6214)*	14215 (6448)*
860D	46 (117 cm)	14270 (6214)*	14790 (6448)*
880D	56 (1422)	18475 (8380)*	18995 (8615)*
890D	68 (1730)	19640 (8908)**	20160(9144)**
8100D	79 (2010)	20635 (9360)***	211585 (9596)***

\*\*\*INCLUDES STANDARD 18' SUBBASE  
 \*\*\*INCLUDES STANDARD 20' SUBBASE  
 \*\*\*INCLUDES STANDARD 22' SUBBASE

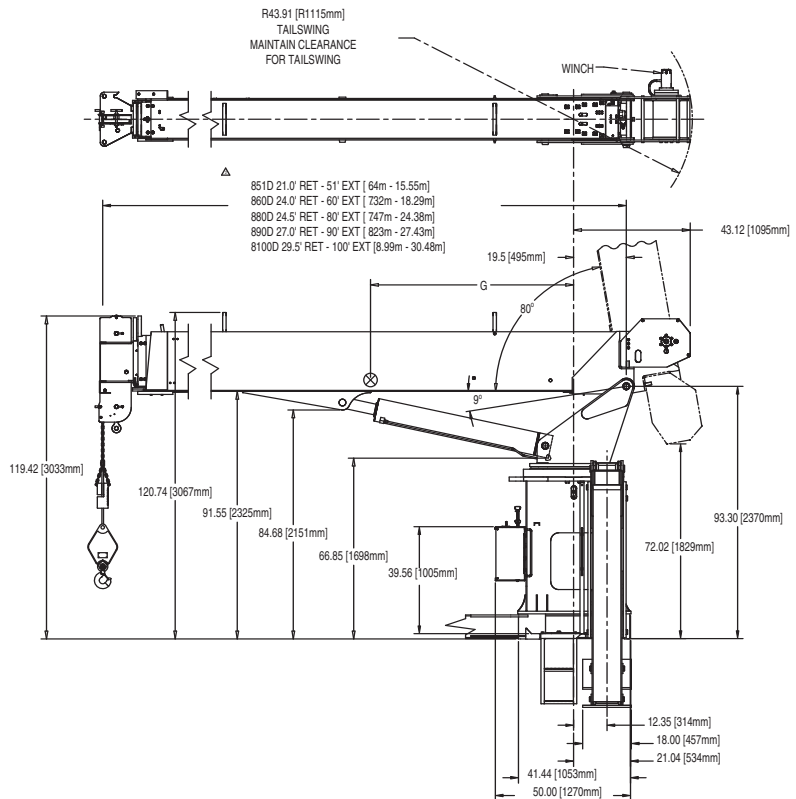

800D



## Regional Headquarters

### Americas

Manitowoc, Wisconsin, USA

Tel: +1 920 684 6621

Fax: +1 920 683 6278

Shady Grove, Pennsylvania, USA

Tel: +1 717 597 8121

Fax: +1 717 597 4062

## Regional Offices

### Americas

#### Brazil

Alphaville

Tel: +55 11 3103 0200

Fax: +55 11 4688 2013

#### Mexico

Monterrey

Tel: +52 81 8124 0128

Fax: +52 81 8124 0129

### Europe, Middle East, Africa

#### Algeria

Hydra

Tel: +21 3 21 48 1173

Fax: +21 3 21 48 1454

#### Czech Republic

Netvorice

Tel: +420 317 78 9313

Fax: +420 317 78 9314

#### France

Baudemont

Tel: +33 385 28 2589

Fax: +33 385 28 0430

#### Cergy

Tel: +33 130 31 3150

Fax: +33 130 38 6085

#### Decines

Tel: +33 472 81 5000

Fax: +33 472 81 5010

#### Germany

Langenfeld

Tel: +49 21 73 8909-0

Fax: +49 21 73 8909 30

#### Hungary

Budapest

Tel: +36 13 39 8622

Fax: +36 13 39 8622

#### Italy

Parabiago

Tel: +390 331 49 3311

Fax: +390 331 49 3330

### Europe, Middle East, Africa

Ecully, France

Tel: +33 472 18 2020

Fax: +33 472 18 2000

#### Netherlands

Breda

Tel: +31 76 578 3999

Fax: +31 76 578 3978

#### Poland

Warsaw

Tel: +48 22 843 3824

Fax: +48 22 843 3471

#### Portugal

Alfena

Tel: +351 229 69 8840

Fax: +351 229 69 8848

Lisbon

Tel: +351 212 109 340

Fax: +351 212 109 349

#### Russia

Moscow

Tel: +7 495 641 2359

Fax: +7 495 641 2358

#### U.A.E.

Dubai

Tel: +971 4 3381 861

Fax: +971 4 3382 343

#### U. K.

Middlesex

Tel: +44 1 895 43 0053

Fax: +44 1 895 45 9500

Sunderland

Tel: +44 191 522 2000

Fax: +44 191 522 2052

### Asia – Pacific

#### Australia

Melbourne

Tel: +61 3 9 336 1300

Fax: +61 3 9 336 1322

Sydney

Tel: +61 2 9 896 4433

Fax: +61 2 9 896 3122

### Asia – Pacific

Shanghai, China

Tel: +86 21 51113579

Fax: +86 21 51113578

Singapore

Tel: +65 6264 1188

Fax: +65 6862 4142

#### China

Beijing

Tel: +86 10 58674761

Fax: +86 10 58674760

Xi'an

Tel: +86 29 87891465

Fax: +86 29 87884504

#### Korea

Seoul

Tel: +82 2 3439 0400

Fax: +82 2 3439 0405

#### Philippines

Makati City

Tel: +63 2 844 9437

Fax: +63 2 844 4712

#### Factories

Brazil

Alphaville

China

Zhangjiagang

France

Charlieu

La Clayette

Moulins

Germany

Wilhelmshaven

India

Calcutta

Pune

Italy

Niella Tanaro

Portugal

Baltar

Fânzeres

Slovakia

Saris

U.S.A.

Manitowoc

Port Washington

Shady Grove



Constant improvement and engineering progress make it necessary that we reserve the right to make specification, equipment and price changes without notice. Illustrations shown may include optional equipment and accessories, and may not include all standard equipment.