



**TRUCK CRANES**  
**T 780**

**DATA SHEET – IMPERIAL**

# T 780



**Features:**

- ▶ 80 T Maximum Lifting Capacity
- ▶ 126 ft Maximum Boom Length
- ▶ 133 ft Maximum Tip Height
- ▶ Engine Configurations up to 500 hp
- ▶ Automatic and Manual Transmission Options
- ▶ Air-ride Suspension
- ▶ Travel Speeds up to 65 mph

**WORKS FOR YOU.™**

# CONTENTS

Page:

**Key** ..... 3

## Dimensions

Crane Dimensions and Boom Transport Dolly Dimensions ..... 4  
Specifications ..... 5  
Specifications with Dolly and Boom Over Rear ..... 6  
Range Diagram ..... 7







## Load Charts

15,000 lb Counterweight ..... 8  
11,000 lb Counterweight ..... 11  
7,000 lb Counterweight ..... 13  
5,000 lb Counterweight ..... 16

## Technical Descriptions

Hydraulics ..... 18  
Upper Operator Cab ..... 18  
Boom Controls ..... 18  
Counterweight ..... 18  
Hoists and Rope ..... 19  
Engine and Transmission ..... 19  
Lower Operator Cab ..... 19  
Chassis and Related Components ..... 20  
Boom and Components ..... 20

**Notes** ..... 21

	Counterweight		Main boom with auxiliary head / rooster sheave
	Lifting capacity on outriggers		Auxiliary hoist
	Radius		Hook and ball
	Main boom		Swing brake
	Maximum axle loads		Heating and air conditioning
	Tires		Crane in standard configuration
	Hook block		Load limiter / safety devices
	Main hoist		Engine
	Travel speed		Electrical system
	Gradeability – road		Transmission
	Swing		Rated weight on hook block
	Boom telescoping		Boom over the rear
	Maximum line pull		Steering
	Rope diameter		Hydraulics
	Rope length		Hook block (capacity-sheaves-rope diameter)

# CRANE DIMENSIONS

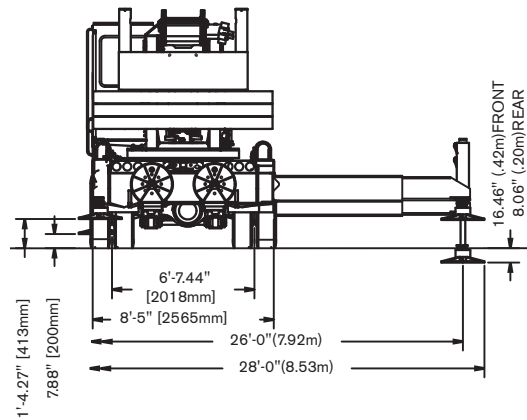
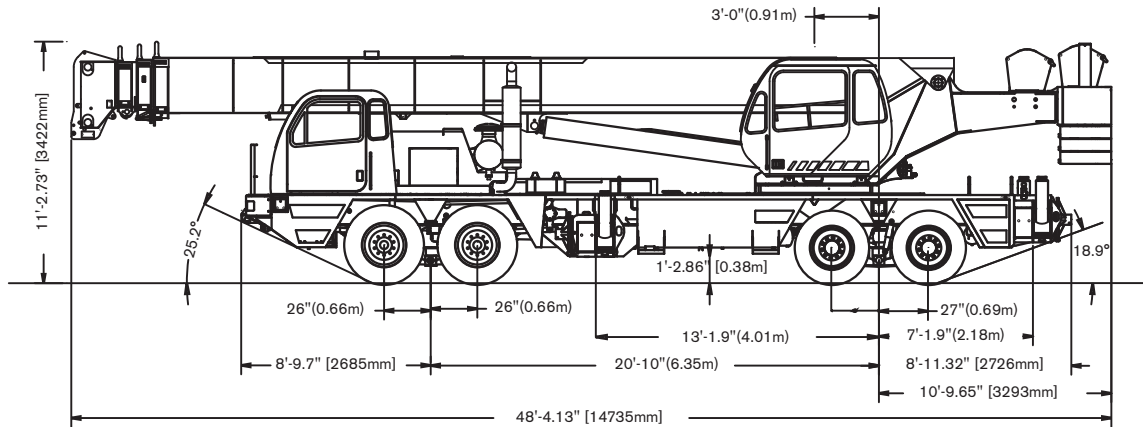



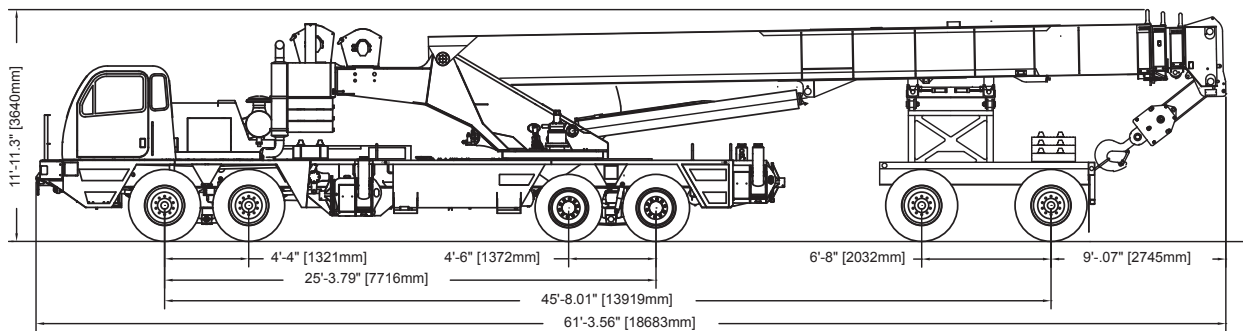

# BOOM TRANSPORT DOLLY DIMENSIONS













## Weight And Axle Load Chart: Boom In Front Travel Position

Icon	Configuration	Front Axle Load 48,000 Lbs Max	Rear Axle Load 60,000 Lbs Max	Gross Vehicle Weight
	Crane with 1/4 tank fuel 200 lb Operator seated in cab Front Tires: 445/65 20PR Rear Tires: 315/80 22.5 20PR 126 ft Boom/No Jib 2850 lb rear counterweight	36,781	44,474	81,255

### Counterweight Additions:

	2,000 lb semi-permanent rear & 1,000 lb front bumper	+ 647	+ 2,374	+ 3,020
	2,000 lb removable on rear	- (904)	+ 2,904	+ 2,000
	4,000 lb removable on rear	- (1,807)	+ 5,807	+ 4,000
	2,000 lb removable on carrier deck	+ 1,485	+ 515	+ 2,000
	4,000 lb removable on carrier deck	+ 2,969	+ 1,031	+ 4,000

### Other Additions:

	Full Tank of Fuel	+ 244	+ 301	+ 545
	Auxiliary hoist w/drum roller and 600 ft of 16x9 class wire rope	- (18)	+ 102	+ 84
	Spin resistant wire rope – main hoist	- (31)	+ 127	+ 96
	Spin resistant wire rope – auxiliary hoist	- (42)	+ 138	+ 96
	Electric remote control	+ 100	+ 100	+ 200
	32 ft swing-on jib	+ 1,393	- (123)	+ 1,270
	32 ft to 57 ft extensible swing-on jib	+ 2,262	- (92)	+ 2,170
	Auxiliary boom head	+ 227	- (102)	+ 125
	80 T hook block on bumper 5 sheave, quick reeving	+ 2,569	- (961)	+ 1,608
	12 T hook block on bumper	+ 669	- (250)	+ 419

### 15,000 lb Counterweight Package Consists of:

- one 2,850 lb rear superstructure fixed weight
- one 1,000 lb front bumper semi-fixed weight
- one 2,000 lb semi-fixed weight
- one 2,000 lb removable weight
- two 4,000 lb removable weight







**DO NOT add additional counterweight**

# SPECIFICATIONS











## Weight And Axle Load Chart: With Dolly and Boom Over Rear

Icon	Configuration	Front Axle Load 48,000 Lbs Max	Rear Axle Load 60,000 Lbs Max	Dolly	Gross Vehicle Weight
	Crane w/ 1/4 tank fuel 200 lb Operator seated in Cab Front Tires: 445/65 20PR Rear Tires: 315/80 22.5 20PR 126 ft Boom/No Jib 2850 lb rear counterweight	29,162	37,299	20,614	87,075

### Counterweight Additions:

	2,000 lb semi-permanent rear & 1,000 lb front bumper	+ 3,059	- (39)	+ 0	+ 3,020
	2,000 lb removable on rear	+ 1,485	+ 515	+ 0	+ 2,000
	4,000 lb removable on rear	+ 2,970	+ 1,030	+ 0	+ 4,000
	2,000 lb removable on carrier deck	+ 1,485	+ 515	+ 0	+ 2,000
	4,000 lb removable on carrier deck	+ 2,970	+ 1,030	+ 0	+ 4,000
	4,000 lb removable on dolly	+ 0	+ 0	+ 4,000	+ 4,000

### Other Additions:

	Full Tank of Fuel	+ 244	+ 301	+ 0	+ 545
	Auxiliary hoist w/drum roller and 600 ft of 16x9 class wire rope	+ 43	+ 41	+ 0	+ 84
	Spin resistant wire rope – main hoist	+ 59	+ 37	+ 0	+ 96
	Spin resistant wire rope – auxiliary hoist	+ 70	+ 26	+ 0	+ 96
	Electric remote control	+ 100	+ 100	+ 0	+ 200
	32 ft swing-on jib	+ 13	+ 18	+ 1,239	+ 1,270
	32 ft to 57 ft extensible swing-on jib	+ 62	+ 86	+ 2,022	+ 2,170
	Auxiliary boom head	- (43)	- (60)	+ 228	+ 125
	80 T hook block on bumper 5 sheave, quick reeving	- (27)	- (37)	+ 1,672	+ 1,608
	12 T hook block on bumper	- (7)	- (10)	+ 436	+ 419

### 15,000 lb Counterweight Package Consists of:

- one 2,850 lb rear superstructure fixed weight
- one 1,000 lb front bumper semi-fixed weight
- one 2,000 lb semi-fixed weight
- one 2,000 lb removable weight
- two 4,000 lb removable weight

**DO NOT add additional counterweight**

# RANGE DIAGRAM

T 780

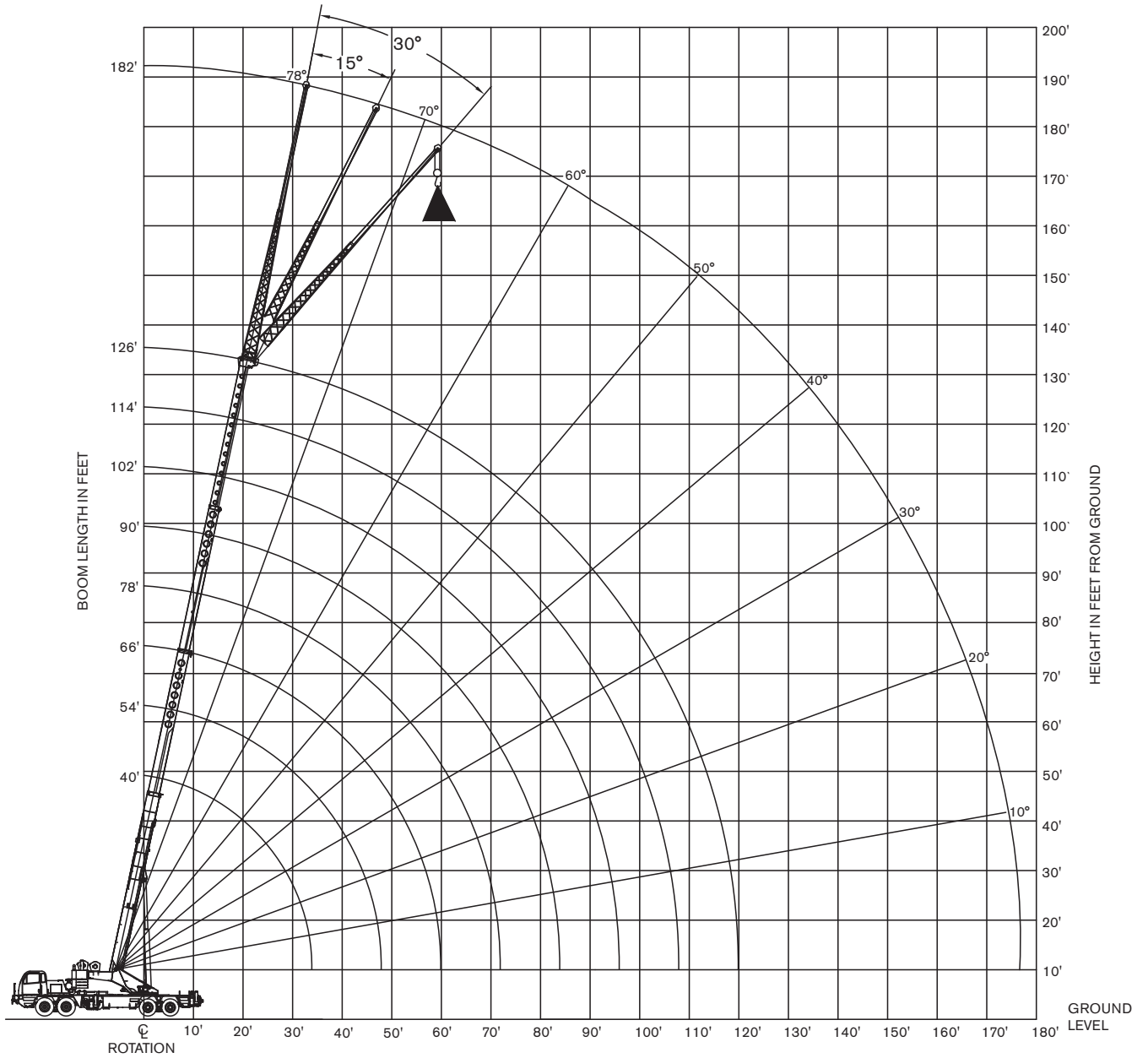

# LOAD CHARTS

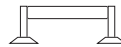

 15,000 lb

 100%

 360°

 40 to 126 ft

ASME Standard  
B 30.5

	Boom Length (ft)								
	40	54	66	78	90	102	114	126	
ft	lb	lb	lb	lb	lb	lb	lb	lb	ft
10	160,000	102,500							10
12	125,600	102,500							12
15	108,900	100,500	80,600						15
20	83,800	84,800	71,900	62,200	56,200				20
25	65,500	66,500	64,800	55,700	48,000	41,900			25
30	52,200	53,600	54,000	49,700	41,700	36,400	31,500		30
35		40,900	41,500	41,700	36,600	32,100	29,500	24,700	35
40		32,500	33,100	33,400	32,900	28,600	26,200	24,600	40
45		26,400	27,100	27,400	27,600	25,700	23,500	22,100	45
50		19,000	22,500	22,900	23,100	23,300	21,400	20,000	50
55			19,000	19,400	19,700	19,800	19,500	18,200	55
60				16,600	16,800	17,000	17,100	16,600	60
65				14,200	14,500	14,700	14,800	14,900	65
70					12,600	12,800	12,900	13,000	70
75					11,000	11,100	11,300	11,400	75
80					9,500	9,800	9,900	10,000	80
85						8,500	8,700	8,800	85
90						7,500	7,700	7,700	90
95						6,500	6,700	6,800	95
100							5,800	6,000	100
105							5,000	5,200	105
110								4,500	110
115								3,900	115



 15,000 lb

 100%

 Over Rear

 40 to 126 ft

ASME Standard  
B 30.5

	Boom Length (ft)									
	40	54	66	78	90	102	114	126		
ft	lb	lb	lb	lb	lb	lb	lb	lb	ft	
10	160,000	102,500							10	
12	125,600	102,500							12	
15	108,900	100,500	80,600						15	
20	84,500	85,300	71,900	62,200	56,200				20	
25	65,500	66,500	64,800	55,700	48,000	41,900			25	
30	52,200	53,600	54,000	49,700	41,700	36,400	31,500		30	
35		40,900	41,500	41,700	36,600	32,100	29,500	24,700	35	
40		32,500	33,100	33,400	32,900	28,600	26,200	24,600	40	
45		26,400	27,100	27,400	27,600	25,700	23,500	22,100	45	
50			22,500	22,900	23,100	23,300	21,400	20,000	50	
55			19,000	19,400	19,700	19,800	19,500	18,200	55	
60				16,600	16,800	17,000	17,100	16,600	60	
65				14,200	14,500	14,700	14,800	14,900	65	
70					12,300	12,600	12,800	12,900	13,000	70
75						11,000	11,100	11,300	11,400	75
80						9,500	9,800	9,900	10,000	80
85							8,500	8,700	8,800	85
90							7,500	7,700	7,700	90
95							6,500	6,700	6,800	95
100								5,800	6,000	100
105								5,100	5,200	105
110									4,600	110
115									3,900	115

**Notes to lifting capacity**

Lifting capacities do not exceed 85% of tipping load. Weight of hook blocks and slings is part of the load, and is to be deducted from the capacity ratings. Consult operation manual for further details.

**Note:** Data published herein is intended as a guide only and shall not be construed to warrant applicability for lifting purposes. Crane operation is subject to the computer charts and operation manual both supplied with the crane.





# LOAD CHARTS

# T 780

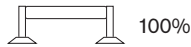
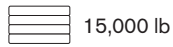

ASME Standard  
B 30.5

## 33 ft Jib with Pullout

0°		15°		30°	
Load Radius ft	360° lbs	Load Radius ft	360° lbs	Load Radius ft	360° lbs
40	12,500	51	8,500	56	6,400
47	12,000	56	8,100	61	6,200
53	11,500	62	7,800	67	6,100
59	10,900	67	7,500	72	5,900
68	9,900	75	7,100	79	5,900
76	9,200	82	6,700	86	5,600
83	8,900	89	6,400	93	5,400
90	7,900	96	6,200	99	5,300
99	6,800	104	5,900	107	5,200
106	5,700	111	5,300	114	5,100
113	4,700	118	4,500	121	4,500
120	3,900	125	3,800	126	3,700
127	3,100	132	3,100	132	3,000
135	2,400	139	2,400	138	2,400
143	1,800	145	1,700		
150	1,300	150	1,300		
152	1,100				



ASME Standard  
B 30.5

## 57 ft Jib with Pullout

0°		15°		30°	
Load Radius ft	360° lbs	Load Radius ft	360° lbs	Load Radius ft	360° lbs
49	6,500	65	4,500	76	3,300
56	6,400	71	4,300	81	3,200
63	6,200	77	4,100	87	3,100
70	6,000	83	3,900	92	3,000
80	5,400	92	3,700	100	2,900
89	4,900	100	3,500	107	2,800
98	4,500	108	3,300	114	2,700
106	4,200	115	3,100	121	2,600
116	3,800	124	2,900	129	2,500
126	3,500	132	2,800	136	2,500
134	3,300	140	2,700	143	2,400
142	3,100	147	2,600	149	2,400
150	2,500	154	2,300	156	2,300
159	1,900	162	1,800	162	1,800
167	1,400	169	1,400		
173	1,000	174	1,000		
177	800				

### Notes to lifting capacity

Lifting capacities do not exceed 85% of tipping load. Weight of hook blocks and slings is part of the load, and is to be deducted from the capacity ratings. Consult operation manual for further details.

**Note:** Data published herein is intended as a guide only and shall not be construed to warrant applicability for lifting purposes. Crane operation is subject to the computer charts and operation manual both supplied with the crane.

# LOAD CHARTS

 15,000 lb



 Over Rear

ASME Standard  
B 30.5

Boom		Travel Speed		
Radius	Length	0 mph	Creep	2.5 mph
ft	ft	lb	lb	lb
10	40	53,700	38,700	31,200
12	40	49,300	35,300	28,400
15	40	43,800	31,100	24,700
20	40	33,000	25,500	19,900
25	54	23,400	21,100	16,300
30	54	17,700	17,700	13,300
35	54	13,700	13,700	10,900
40	66	11,100	11,100	9,300
45	66	8,900	8,900	7,900
50	66	7,200	7,200	6,700
55	78	5,800	5,800	5,700
60	78	4,600	4,600	4,600
65	78	3,700	3,700	3,700
70	90	3,000	3,000	3,000
75	90	2,400	2,400	2,400
80	90	1,800	1,800	1,800

### Notes to lifting capacity

Lifting capacities do not exceed 85% of tipping load. Weight of hook blocks and slings is part of the load, and is to be deducted from the capacity ratings. Consult operation manual for further details.

**Note:** Data published herein is intended as a guide only and shall not be construed to warrant applicability for lifting purposes. Crane operation is subject to the computer charts and operation manual both supplied with the crane.

# LOAD CHARTS

# T 780

 11,000 lb

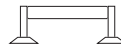
 100%

 360°

 40 to 126 ft

 ASME Standard  
B 30.5

ft	Boom Length (ft)								ft
	40	54	66	78	90	102	114	126	
lb	lb	lb	lb	lb	lb	lb	lb	lb	lb
10	160,000	102,500							10
12	125,600	102,500							12
15	108,900	100,500	80,600						15
20	82,000	83,100	71,900	62,200	56,200				20
25	63,400	64,500	64,800	55,700	48,000	41,900			25
30	49,000	50,400	50,800	49,700	41,700	36,400	31,500		30
35		38,400	38,900	39,200	36,600	32,100	29,500	24,700	35
40		30,300	30,900	31,200	31,400	28,600	26,200	24,600	40
45		24,600	25,200	25,600	25,700	25,700	23,500	22,100	45
50			20,900	21,300	21,500	21,600	21,400	20,000	50
55			17,500	17,900	18,100	18,200	18,300	18,200	55
60				15,100	15,400	15,500	15,600	15,700	60
65				12,800	13,100	13,300	13,400	13,400	65
70				11,000	11,300	11,400	11,500	11,600	70
75					9,700	9,900	10,000	10,100	75
80					8,300	8,500	8,700	8,800	80
85						7,400	7,500	7,600	85
90						6,400	6,500	6,600	90
95						5,500	5,600	5,800	95
100							4,900	5,000	100
105							4,100	4,300	105
110								3,600	110
115								3,100	115

 11,000 lb

 100%

 Over Rear

 40 to 126 ft

 ASME Standard  
B 30.5

ft	Boom Length (ft)								ft
	40	54	66	78	90	102	114	126	
lb	lb	lb	lb	lb	lb	lb	lb	lb	lb
10	160,000	102,500							10
12	125,600	102,500							12
15	108,900	100,500	80,600						15
20	82,000	83,100	71,900	62,200	56,200				20
25	63,400	64,500	64,800	55,700	48,000	41,900			25
30	49,000	50,400	50,800	49,700	41,700	36,400	31,500		30
35		38,400	38,900	39,200	36,600	32,100	29,500	24,700	35
40		30,300	30,900	31,200	31,400	28,600	26,200	24,600	40
45		24,600	25,200	25,600	25,700	25,700	23,500	22,100	45
50			20,900	21,300	21,500	21,600	21,400	20,000	50
55			17,500	17,900	18,200	18,300	18,400	18,200	55
60				15,200	15,500	15,700	15,800	15,800	60
65				13,000	13,300	13,500	13,600	13,700	65
70				11,200	11,500	11,700	11,800	11,900	70
75					9,900	10,100	10,200	10,300	75
80					8,600	8,800	8,900	9,000	80
85						7,600	7,800	7,900	85
90						6,600	6,700	6,900	90
95						5,700	5,900	6,000	95
100							5,100	5,200	100
105							4,300	4,500	105
110								3,800	110
115								3,200	115

### Notes to lifting capacity

Lifting capacities do not exceed 85% of tipping load. Weight of hook blocks and slings is part of the load, and is to be deducted from the capacity ratings. Consult operation manual for further details.

**Note:** Data published herein is intended as a guide only and shall not be construed to warrant applicability for lifting purposes. Crane operation is subject to the computer charts and operation manual both supplied with the crane.

# LOAD CHARTS

 11,000 lb



 Over Rear

ASME Standard  
B 30.5

Boom		Travel Speed		
Radius	Length	0 mph	Creep	2.5 mph
ft	ft	lb	lb	lb
10	40	56,000	41,000	33,500
12	40	51,500	37,500	30,500
15	40	45,500	33,000	26,700
20	40	29,500	27,200	21,700
25	54	21,100	21,100	17,800
30	54	16,000	16,000	14,700
35	54	12,600	12,600	12,100
40	66	9,700	9,700	9,700
45	66	7,500	7,500	7,500
50	66	5,900	5,900	5,900
55	78	4,800	4,800	4,800
60	78	4,000	4,000	4,000
65	78	3,300	3,300	3,300
70	90	2,800	2,800	2,800
75	90	2,100	2,100	2,100

### Notes to lifting capacity

Lifting capacities do not exceed 85% of tipping load. Weight of hook blocks and slings is part of the load, and is to be deducted from the capacity ratings. Consult operation manual for further details.

**Note:** Data published herein is intended as a guide only and shall not be construed to warrant applicability for lifting purposes. Crane operation is subject to the computer charts and operation manual both supplied with the crane.

# LOAD CHARTS

# T 780



7,000 lb

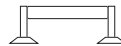

100%



360°



40 to 126 ft

ASME Standard  
B 30.5

ft	Boom Length (ft)								ft
	40	54	66	78	90	102	114	126	
lb	lb	lb	lb	lb	lb	lb	lb	lb	lb
10	149,300	102,500							10
12	125,600	102,500							12
15	106,300	100,500	80,600						15
20	79,600	80,600	71,900	62,200	56,200				20
25	61,500	62,500	63,100	55,700	48,000	41,900			25
30	44,600	46,000	46,400	46,700	41,700	36,400	31,500		30
35		34,900	35,400	35,600	35,800	32,100	29,500	24,700	35
40		27,400	28,000	28,300	28,500	28,600	26,200	24,600	40
45		22,000	22,700	23,000	23,200	23,300	23,400	22,100	45
50			18,700	19,100	19,300	19,400	19,500	19,600	50
55			15,500	15,900	16,100	16,300	16,300	16,400	55
60				13,200	13,500	13,900	13,700	13,800	60
65				11,100	11,400	11,900	11,600	11,700	65
70				9,300	9,600	10,200	9,900	10,000	70
75					8,100	8,700	8,400	8,500	75
80					6,900	7,500	7,200	7,300	80
85						6,400	6,100	6,200	85
90						5,500	5,200	5,300	90
95						4,600	4,400	4,500	95
100							3,600	3,700	100
105							2,900	3,100	105
110								2,500	110
115								2,000	115



7,000 lb



100%



Over Rear



40 to 126 ft

ASME Standard  
B 30.5

ft	Boom Length (ft)								ft
	40	54	66	78	90	102	114	126	
lb	lb	lb	lb	lb	lb	lb	lb	lb	lb
10	160,000	102,500							10
12	125,600	102,500							12
15	108,900	100,500	80,600						15
20	79,600	80,600	71,900	62,200	56,200				20
25	61,500	62,500	63,100	55,700	48,000	41,900			25
30	44,600	46,000	46,400	46,700	41,700	36,400	31,500		30
35		34,900	35,400	35,600	35,800	32,100	29,500	24,700	35
40		27,400	28,000	28,300	28,500	28,600	26,200	24,600	40
45		22,000	22,700	23,000	23,200	23,300	23,400	22,100	45
50			18,700	19,100	19,300	19,400	19,500	19,600	50
55			15,500	15,900	16,200	16,300	16,400	16,500	55
60				13,400	13,700	13,900	14,000	14,100	60
65				11,400	11,700	11,900	12,000	12,100	65
70				9,700	10,000	10,200	10,300	10,400	70
75					8,500	8,700	8,900	9,000	75
80					7,300	7,500	7,600	7,800	80
85						6,400	6,600	6,700	85
90						5,500	5,600	5,700	90
95						4,600	4,800	4,900	95
100							4,000	4,200	100
105							3,400	3,500	105
110								2,900	110
115								2,400	115

### Notes to lifting capacity

Lifting capacities do not exceed 85% of tipping load. Weight of hook blocks and slings is part of the load, and is to be deducted from the capacity ratings. Consult operation manual for further details.

**Note:** Data published herein is intended as a guide only and shall not be construed to warrant applicability for lifting purposes. Crane operation is subject to the computer charts and operation manual both supplied with the crane.

# LOAD CHARTS

 7,000 lb

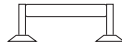
 100%

 360°

ASME Standard  
B 30.5

## 33 ft Jib with Pullout

0°		15°		30°	
Load Radius ft	360° lbs	Load Radius ft	360° lbs	Load Radius ft	360° lbs
39	12,500	49	8,500	57	6,400
46	12,000	55	8,100	62	6,200
53	11,500	60	7,800	67	6,100
59	10,900	66	7,500	72	5,900
67	9,900	73	7,100	79	5,900
75	9,200	81	6,700	86	5,600
82	8,000	87	6,400	93	5,400
88	6,800	94	6,000	99	5,300
97	5,400	102	4,900	106	4,500
104	4,200	110	3,900	113	3,600
111	3,300	117	3,100	120	2,900
117	2,600	123	2,400	126	2,200
125	1,800	130	1,600	132	1,600
135	1,200	137	1,000	138	1,100

 7,000 lb

 100%

 360°

ASME Standard  
B 30.5

## 57 ft Jib with Pullout

0°		15°		30°	
Load Radius ft	360° lbs	Load Radius ft	360° lbs	Load Radius ft	360° lbs
49	6,500	66	4,500	75	3,300
57	6,400	72	4,300	81	3,200
64	6,200	78	4,100	86	3,100
71	6,000	84	3,900	92	3,000
81	5,400	92	3,700	99	2,900
90	4,900	100	3,500	107	2,800
98	4,500	108	3,300	114	2,700
106	4,200	115	3,100	120	2,600
116	3,800	124	2,900	128	2,500
124	3,200	132	2,800	136	2,500
132	2,400	140	2,200	143	2,200
139	1,800	146	1,700	149	1,700
147	1,200	154	1,200	155	1,200

### Notes to lifting capacity

Lifting capacities do not exceed 85% of tipping load. Weight of hook blocks and slings is part of the load, and is to be deducted from the capacity ratings. Consult operation manual for further details.

**Note:** Data published herein is intended as a guide only and shall not be construed to warrant applicability for lifting purposes. Crane operation is subject to the computer charts and operation manual both supplied with the crane.

# LOAD CHARTS

# T 780

 7,000 lb

 Over Rear

 ASME Standard  
B 30.5

Boom		Travel Speed		
Radius	Length	0 mph	Creep	2.5 mph
ft	ft	lb	lb	lb
10	40	56,000	41,000	33,500
12	40	51,500	37,500	30,500
15	40	45,500	33,000	26,700
20	40	29,500	27,200	21,700
25	54	21,100	21,100	17,800
30	54	16,000	16,000	14,700
35	54	12,600	12,600	12,100
40	66	9,700	9,700	9,700
45	66	7,500	7,500	7,500
50	66	5,900	5,900	5,900
55	78	4,800	4,800	4,800
60	78	4,000	4,000	4,000
65	78	3,300	3,300	3,300
70	90	2,800	2,800	2,800

### Notes to lifting capacity

Lifting capacities do not exceed 85% of tipping load. Weight of hook blocks and slings is part of the load, and is to be deducted from the capacity ratings. Consult operation manual for further details.

**Note:** Data published herein is intended as a guide only and shall not be construed to warrant applicability for lifting purposes. Crane operation is subject to the computer charts and operation manual both supplied with the crane.

# LOAD CHARTS

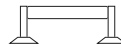

 5,000 lb

 100%

 360°

 40 to 126 ft

ASME Standard  
B 30.5

	Boom Length (ft)								
	40	54	66	78	90	102	114	126	
ft	lb	lb	lb	lb	lb	lb	lb	lb	ft
10	148,200	102,500							10
12	125,600	102,500							12
15	108,900	100,500	80,600						15
20	82,000	83,100	71,900	62,200	56,200				20
25	63,400	64,500	64,800	55,700	48,000	41,900			25
30	49,000	50,400	50,800	49,700	41,700	36,400	31,500		30
35		38,400	38,900	39,200	36,600	32,100	29,500	24,700	35
40		30,300	30,900	31,200	31,400	28,600	26,200	24,600	40
45		24,600	25,200	25,600	25,700	25,700	23,500	22,100	45
50			20,900	21,300	21,500	21,600	21,400	20,000	50
55			17,500	17,900	18,100	18,200	18,300	18,200	55
60				15,100	15,400	15,500	15,600	15,700	60
65				12,800	13,100	13,300	13,400	13,400	65
70				11,000	11,300	11,400	11,500	11,600	70
75					9,700	9,900	10,000	10,100	75
80					8,300	8,500	8,700	8,800	80
85						7,400	7,500	7,600	85
90						6,400	6,500	6,600	90
95						5,500	5,600	5,800	95
100							4,900	5,000	100
105							4,100	4,300	105
110								3,600	110
115								3,100	115



 5,000 lb

 100%

 Over Rear

 40 to 126 ft

ASME Standard  
B 30.5

	Boom Length (ft)								
	40	54	66	78	90	102	114	126	
ft	lb	lb	lb	lb	lb	lb	lb	lb	ft
10	160,000	102,500							10
12	125,600	102,500							12
15	108,900	100,500	80,600						15
20	82,000	83,100	71,900	62,200	56,200				20
25	63,400	64,500	64,800	55,700	48,000	41,900			25
30	49,000	50,400	50,800	49,700	41,700	36,400	31,500		30
35		38,400	38,900	39,200	36,600	32,100	29,500	24,700	35
40		30,300	30,900	31,200	31,400	28,600	26,200	24,600	40
45		24,600	25,200	25,600	25,700	25,700	23,500	22,100	45
50			20,900	21,300	21,500	21,600	21,400	20,000	50
55			17,500	17,900	18,200	18,300	18,400	18,200	55
60				15,200	15,500	15,700	15,800	15,800	60
65				13,000	13,300	13,500	13,600	13,700	65
70				11,200	11,500	11,700	11,800	11,900	70
75					9,900	10,100	10,200	10,300	75
80					8,600	8,800	8,900	9,000	80
85						7,600	7,800	7,900	85
90						6,600	6,700	6,900	90
95						5,700	5,900	6,000	95
100							5,100	5,200	100
105							4,300	4,500	105
110								3,800	110
115								3,200	115

**Notes to lifting capacity**

Lifting capacities do not exceed 85% of tipping load. Weight of hook blocks and slings is part of the load, and is to be deducted from the capacity ratings. Consult operation manual for further details.

**Note:** Data published herein is intended as a guide only and shall not be construed to warrant applicability for lifting purposes. Crane operation is subject to the computer charts and operation manual both supplied with the crane.





# LOAD CHARTS

# T 780

 5,000 lb

 Over Rear

 ASME Standard  
B 30.5

Boom		Travel Speed		
Radius	Length	0 mph	Creep	2.5 mph
ft	ft	lb	lb	lb
10	40	55,600	40,600	33,200
12	40	49,100	37,200	30,200
15	40	40,000	32,700	26,400
20	40	27,500	26,900	21,400
25	54	18,200	18,200	17,500
30	54	12,400	12,400	12,400
35	54	9,900	9,900	9,900
40	66	7,700	7,700	7,700
45	66	5,600	5,600	5,600
50	66	4,700	4,700	4,700
55	78	3,600	3,600	3,600
60	78	2,700	2,700	2,700
65	78	1,800	1,800	1,800

### Notes to lifting capacity

Lifting capacities do not exceed 85% of tipping load. Weight of hook blocks and slings is part of the load, and is to be deducted from the capacity ratings. Consult operation manual for further details.





**Note:** Data published herein is intended as a guide only and shall not be construed to warrant applicability for lifting purposes. Crane operation is subject to the computer charts and operation manual both supplied with the crane.

# TECHNICAL DESCRIPTIONS



## Hydraulics

	Three Pump System Main hoist/boom hoist and telescope tandem pump Outrigger and swing Power steering Simultaneous operation of hydraulic functions Two-speed boom extension	57.3 / 42.6 gal/min @ 4,500 psi 21.2 gal/min 3,500 psi 8 gal/min @ 1,900 psi
	Full Flow with bypass protection Suction Return	250 micron screen 5 micron filter
	Pressurized Tank with Sight Level Gauge	202 gal

## Upper Operator Cab

	Upper Cab Sliding door on left side Sliding window on the right side Tilting, tinted glass skylight Removable front windshield Six-way adjustable seat with armrest dual-axis electro-proportional joysticks Joystick control for hoist(s), swing and boom elevation Foot pedals for swing brake, boom telescope and engine rpm Hand control for engine rpm
 	Optional Features for Upper Cab Air conditioning – hydraulically powered Heater and air conditioning package – hydraulically powered Liquid Propane (LP) Cab Heater Single-Axis armrest mounted controls Work Lights Upper cab remote carrier control AM/FM radio with cassette
	Rated capacity indicator with pictograph display of boom radius, boom angle, boom length, allowable load, actual load and % of allowable load Settable alarms for swing angle, boom length, boom angle, tip height and work area exclusion zone











## Boom Controls

	Foot pedal actuated multi-disc brake and air actuated 360° house lock
	Hydraulic driven double planetary reduction gear drive <span style="float: right;">2.5 rev/min</span>



## Counterweight

	Main counterweight with integrated hydraulic removal system is bolted to upper crane structure Hydraulic system allows weights to be removed and attached without additional lifting equipment for placement on carrier deck or dolly trailer	15,000 lb standard counterweight package
---	--	--

## Hoists and Rope

	Two speeds First layer (no load speed) Fifth layer (no load speed)	Low Speed: 200 ft/min 287 ft/min	High Speed: 320 ft/min 460 ft/min
	First layer Fifth layer	Low Speed: 18,450 lb 12,845 lb	High Speed: 10,002 lb 6,963 lb
	Permissible line pull		13,800 lb
			6x19 IWRC XIPS
	Maximum useable		561 ft
	Rope diameter		0.75 in
	Two speeds First layer (no load speed) Fifth layer (no load speed)	Low Speed: 200 ft/min 287 ft/min	High Speed: 320 ft/min 460 ft/min
	First layer Fifth layer	Low Speed: 18,450 lb 12,845 lb	High Speed: 10,002 lb 6,963 lb
	Permissible line pull		13,800 lb
	Optional		34x7 Grade 960
	Optional		.75 in

## Engine and Transmission





	<b>Standard Engine and Transmission</b>		
	Detroit Diesel 60 Series Turbocharged and Aftercooled Eaton Fuller		14 L / 435 hp 10 speed manual
	<b>Optional Engine and Transmission</b>		
	Detroit Diesel 60 Series Turbocharged and Aftercooled Allision automatic		14 L / 515 hp 7 speed with lock-up torque converter
	Fuel Capacity		100 gal
	Voltage Batteries Alternator		12 VDC Three 2,400 CCA 130 amp

## Lower Operator Cab











	<b>Lower Cab</b>	
	Hinged door on left side with roll-down window Sliding window on the right side Six-way adjustable seat with seatbelt Cruise control Two speed windshield wiper with washer Jacobs engine brake	

# TECHNICAL DESCRIPTIONS

## Chassis and Related Components

	Hydraulic assist	33 ft 4 in turn radius to CL of tires
	Front axle – maximum capacity Tubular beam with equalizer air suspension mounting Rear axle – maximum capacity Interaxle differential with lock-out. Equalizer beam air suspension mounting	48,000 lb 60,000 lb
	Aluminium wheels with stainless hub covers Front Rear	445/65R22.5-20 PR 315/80R22.5 -20 PR
	Theoretical maximum Manual transmission Automatic transmission	100 +% 100 +%
	Manual transmission Automatic transmission Axle drive system Air brakes with ABS	67 mph 65 mph 8x4 drive Air release / spring set

## Boom and Components

	Full power extension via foot pedal control	Four Section
	Retracted boom length Extended boom length Maximum tip height	40 ft 126 ft 133 ft
	Raised – maximum Lower – minimum	+78° -4°
	<b>Optional</b> Swing-On Jib – Fixed length – Can be offset to 0°, 15°, or 30° Maximum tip height with fixed jib Swing-On Jib – with 25 ft extension – Can be offset to 0°, 15°, or 30° Maximum tip height with extended jib	32 ft 164 ft 33 ft to 57 ft 189 ft
	<b>Optional</b> Boom Dolly	
	5 or 6 metallic load sheaves 2 nylon idler sheaves Quick reeving design	
	Installs only on main boom head Compatible with extendable and fixed swing-on jibs	Single nylon sheave
	5 metallic sheaves Quick reeving design	80 T
	<b>Optional</b> 5 metallic sheaves Quick reeving design	60 T
	Top swivel ball with hook and latch	12 T

---

---

---

---

---

---

---

---

---

---

---

---

---

---

---

---

---

---

---

---

---

---

---

---

# NOTES

---

---

---

---

---

---

---

---

---

---

---

---

---

---

---

---

---

---

---

---

---

---

---



[www.terexcranes.com](http://www.terexcranes.com)

Effective Date: October 2010. Product specifications and prices are subject to change without notice or obligation. The photographs and/or drawings in this document are for illustrative purposes only. Refer to the appropriate Operator's Manual for instructions on the proper use of this equipment. Failure to follow the appropriate Operator's Manual when using our equipment or to otherwise act irresponsibly may result in serious injury or death. The only warranty applicable to our equipment is the standard written warranty applicable to the particular product and sale and Terex makes no other warranty, express or implied. Products and services listed may be trademarks, service marks or trade-names of Terex Corporation and/or its subsidiaries in the USA and other countries. All rights are reserved. Terex is a registered trademark of Terex Corporation in the USA and many other countries. © 2010 Terex Corporation.

Terex Cranes, Global Marketing, Dinglerstraße 24, 66482 Zweibrücken, Germany  
Tel. + 49 (0) 6332 830, Email: [info.cranes@terex.com](mailto:info.cranes@terex.com), [www.terexcranes.com](http://www.terexcranes.com)

TC-DS-I-E-T780 10/10



**WORKS FOR YOU.™**