

GROVE®

GMK4090-1



product guide

features

- 37-142 ft. (11.2-43.2 m) 5-section full power boom
- Patented TWIN-LOCK™ boom pinning system
- 33-56 ft. (10-17 m) bifold luffing lattice swingaway extension hydraulically offset 0° - 40°
- 37,000 lb. (16 800 kg) counterweight with hydraulic installation/removal system
- 422 hp (315 kW) Mercedes OM 501 LA 6 cylinder turbo-charged diesel engine. ZF-Astronic 12 speed forward, 2 speed reverse transmission
- Independent hydro-pneumatic MEGATRAK™ suspension
- All wheel steering



contents

Features

2

Specifications

3

Dimensions

5

Counterweight

6

Trailing Boom Proposal

7

Working Range

8

Load Charts

9

Rated Lifting Capacities

14

features

2

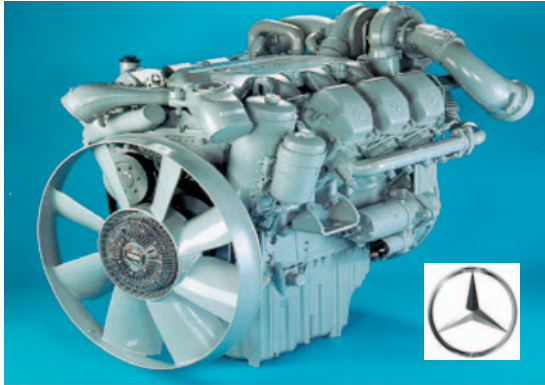

Mercedes-Benz OM501LA
422 bhp (315 kW) @ 1800 rpm
1276 ft./lb. torque (1730 Nm) @ 1080 rpm

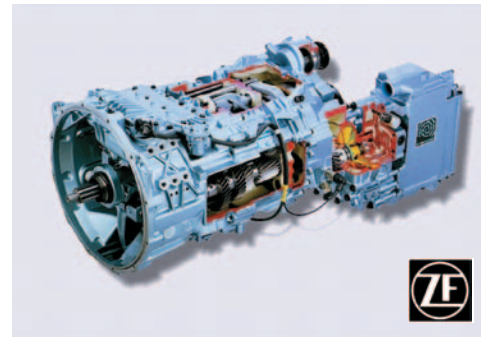

ZF AS Tronic
12 speeds fwd, 2 rev

TWIN-LOCK™
Boom pinning
mechanism
automatically pins
the sections in
position using two
horizontal large
diameter boom
pins

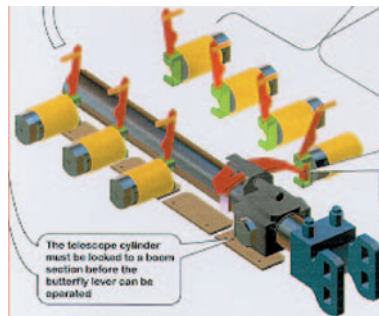

MEGATRAK™
Independent
suspension and
all wheel steer
system allows
wheels to
remain on the
ground at all
times so
stresses and
weight are not
continually
transferred
between axles

LUFFING BI-FOLD SWINGAWAY
Hydraulically offset lattice bi-fold swingaway
lets the operator set the offset from 0°-40°
while under load, from the superstructure
cab

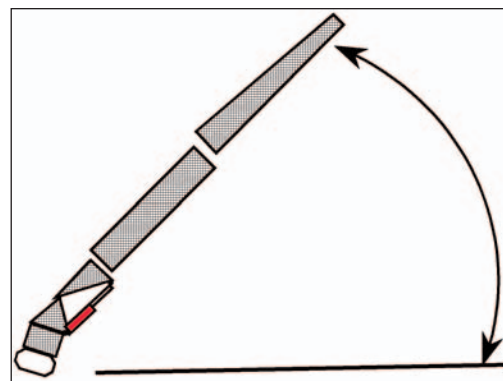

specifications

3

Superstructure

Boom

37 ft. - 142 ft. (11.2 m - 43.2 m) five section, full power boom with patented TWIN-LOCK™ boom pinning system. Maximum tip height: 151 ft. (46 m)

Boom Elevation

Single lift cylinder with safety valve provides boom angle from -3° to +82°.

Hydraulically Offsettable Lattice Extension

33 ft. - 56 ft. (10 m - 17 m) bifold lattice swingaway extension hydraulically offsettable and luffing under load from 5° - 40°. Controlled from the crane cab.

*Offsettable Lattice Extension

33 ft.-56 ft. (10m-17m) bifold swingaway extension manually offset, 0°, 20°, 40°.

Lattice Inserts

Two 16 ft.(5 m) inserts for use with lattice swingaway extension to increase length up to 72 ft. (22 m) or 88 ft. (27 m).

Load Moment & Anti-Two Block System

Load moment and anti-two block system with audio/visual warning and control lever lockout provides electronic display of boom angle, length, radius, tip height, relative load moment, maximum permissible load, load indication and warning of impending two-block condition.

Cab

All aluminum construction cab is tiltable (- 5° to +15°) and includes safety glass and adjustable operator's seat with hydraulic suspension. Other features include engine independent heater, armrest integrated crane controls, and ergonomically arranged instrumentation. Drive/steer controls.

Swing

Axial piston fixed displacement motor and planetary gear box. Holding brake and service brake.

Counterweight

37,000 lbs. (16 783 kg) consisting of various sections with hydraulic installation/removal system controlled from the superstructure cab.

Hydraulic System

2 separate circuits, 1 axial piston variable displacement pump (load sensing) with electronic power limiting control and 1 gear pump for swing. Dual thermostatically controlled oil coolers keep oil at optimum operating temperature.

Tank capacity: 180 gal. (680 l)

Control System

Full electronic control of all crane movements using electrical control levers with automatic reset to zero. Controls are integrated with the LMI and engine management system by CAN-BUS. ECOS system with graphic display.

Hoist

Main and auxiliary hoist are powered by axial piston motor with planetary gear and brake. "Thumb-thumper" hoist drum rotation indicator alerts operator of hoist movement.

	Main	Auxiliary
Line length:	720 ft. (220 m)	720 ft. (220 m)
Rope diameter:	16 mm	16 mm
Line speed:	410 ft./min. (125 m/min)	410 ft./min. (125 m/min)
Line pull:	11,240 lbs. (50 kN)	11,240 lbs. (50 kN)

Electrical System

24 V system with three-phase alternator 28 V/80 A, 2 batteries 12 V/170 Ah.

*Optional Equipment

- *Second spotlight on superstructure cab
- *Stereo/cassette player
- *Air Conditioning
- *24 hr. timer for diesel cab heater
- *Outrigger pad load indicator
- *Worklight mounted on top of base section
- *Boom mounted aircraft warning light
- *Working range limiter
- *Data logger – superstructure

*Denotes optional equipment

GMK 4090-1

specifications

4

Carrier



Chassis

Box-type, torsion resistant frame is fabricated from high-strength steel.



Outrigger System

Four hydraulic two-stage outrigger beams with vertical cylinders and outrigger pads. Outriggers can be set in four positions:

Fully extended (100%)	- 23' (7 m)
Partial	- 19' 8" (6 m)
Retracted	- 16' 5" (5 m)
Fully retracted (0%)	- 7' 7" (2.3 m)

Independent horizontal and vertical movement control on each side of carrier. Electronic crane level indicators at each control station. Automatic level system on carrier.



Engine

Mercedes-Benz OM501LA, diesel, 6 cylinders, water cooled, turbo charged, 422 HP (315 kW) at 1800 rpm. Max. torque: 1,475 ft./lbs. (2000 Nm) at 1080 rpm

Engine emission: EURO II/EUROMOT/EPA/CARB (non road)
Permanent exhaust brake and constant throttle brake.



Fuel Tank Capacity

106 gallons (400 L).



Transmission

ZF-AS TRONIC automatic, 12 forward and 2 reverse speeds.
Single speed transfer case with inter-axle differential lock.



Drive/Steer

8 x 6 x 8



Axles

1st axle line - drive/steer

2nd axle line - steer

3rd axle line - drive/steer (connects for all-wheel steer)

4th axle line - drive/steer

Drive axles with planetary hub reduction and center mounted gearing.



Suspension

Grove exclusive MEGATRAK™ suspension on all wheels independent hydroneumatic system with hydraulic lockout acting on all wheels. The suspension can be raised 6-1/2" (170 mm) or lowered 5" (130 mm) both longitudinally and transversely and features an automatic leveling system for on-highway travel.



Tires

8 tires, 20.5 R25.



Steering

Dual circuit, hydraulic power assisted with a transfer case mounted, ground driven, emergency steering pump. Axles 1, 2, and 4 steer on highway. Separate steering of the 3rd and 4th axle for all wheel steer and crab-steer is controlled by an electric rocker switch.



Brakes

Service brake: pneumatic dual circuit acting on all wheels, air dryer. Anti-lock braking system (ABS). Parking brake: pneumatically operated spring loaded brake acting on axle lines 2 & 4.



Cab

Two-man, aluminum construction driver's cab includes the following features: safety glass; driver and passenger seats with hydraulic suspension, engine-dependent hot water heater, complete instrumentation and driving controls.



Electrical System

24 V system with three-phase alternator 28 V/100A,
2 batteries 12 V/170 Ah.



Maximum Speed

53 mph (85 km/h) with 20.5 R25 tires.



Gradeability (Theoretical)

70% with 20.5 R25 tires.

Miscellaneous Standard Equipment

Trailing boom kit (less dolly); additional hydraulic oil cooler; working light; tool kit; fire extinguisher; rooster sheave; radio cassette in carrier cab.

Optional Equipment

- * 8 x 8 x 8
- * Electric driveline retarder
- * 16.00 R25 tires (vehicle width 9 ft. 10 in. [3 m])
- * 14.00 R25 tires (vehicle width 9 ft. [2.75 m])
- * Engine-independent diesel heater, with engine pre-heater
- * Trailing boom "boost" weight transfer kit
- * Air conditioning
- * Spare tire and wheel with mounting bracket
- * 24 hour timer for diesel heater
- * Aluminum edging for carrier deck
- * Additional strobe lights
- * Worklights for outrigger beams
- * Data logger-carrier

* Denotes optional equipment

GMK 4090-1

GROVE.

dimensions

5

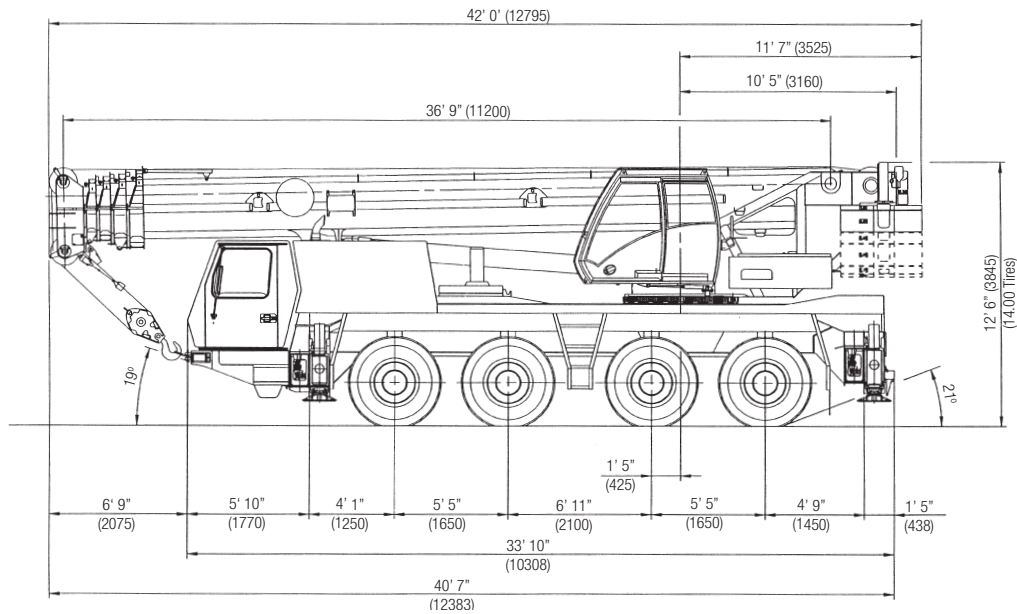
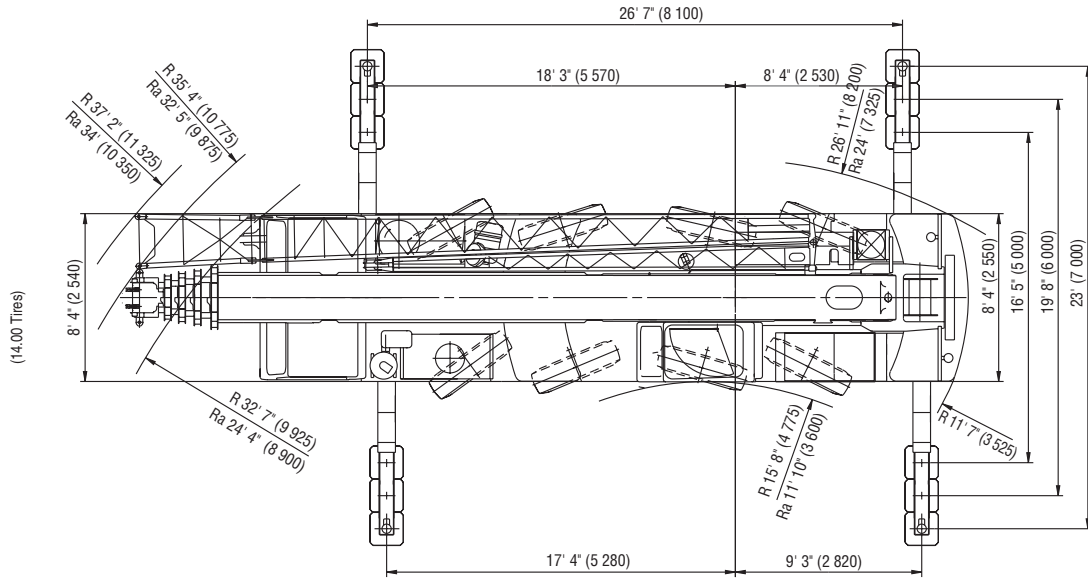

Basic Weights lb. (kg.)	Axles 1 & 2	Axles 3 & 4	Total
Mercedes power, 20.5 tires, auxiliary hoist, 2nd oil cooler, outrigger pads, hydraulic offsettable swingaway with hydraulic reel, 8x6x8 and 2,866 lb. (1 300 kg.) counterweight bolted to superstructure.	53,989 (24 489)	34,229 (15 526)	88,218 (40 015)
Additions:			
Auxiliary boom nose	428 (194)	-251 (-114)	176 (80)
20.5 spare tire	-642 (-291)	1,451 (658)	809 (367)
16.00 spare tire	-560 (-254)	1,276 (579)	716 (325)
14.00 spare tire	-452 (-205)	1036 (470)	584 (265)
Driveline retarder	-55 (-25)	496 (225)	441 (200)
Additional 5,512 lb. (2 500 kg.) baseplate on carrier, 11,023 lb. (5 000 kg.) on superstructure. Total counterweight of 20,500 lb. (9 300 kg.)	-2,332 (-1 058)	18,620 (8 446)	16,288 (7,388)
8x8x8 drive	584 (265)	165 (75)	749 (340)
Substitute:			
IPO counterweight in lieu of auxiliary hoist	298 (135)	-500 (-227)	-202 (-92)
Manual offset swingaway in lieu of hydraulic luffing swingaway	-580 (-263)	293 (133)	-287 (-130)
16.00 tires in lieu of 20.5	-370 (-168)	-370 (-168)	-741 (-336)
14.00 tires in lieu of 20.5	-955 (-433)	-955 (-433)	-1,910 (-866)
Remove:			
Hydraulic luffing swingaway	-3,646 (-1 654)	780 (354)	-2,866 (-1 300)
2,866 lb. (1 300 kg.) bolted counterweight	1,962 (890)	-4,828 (-2 190)	-2,866 (-1 300)

GMK4090-1

GROVE

counterweight

6

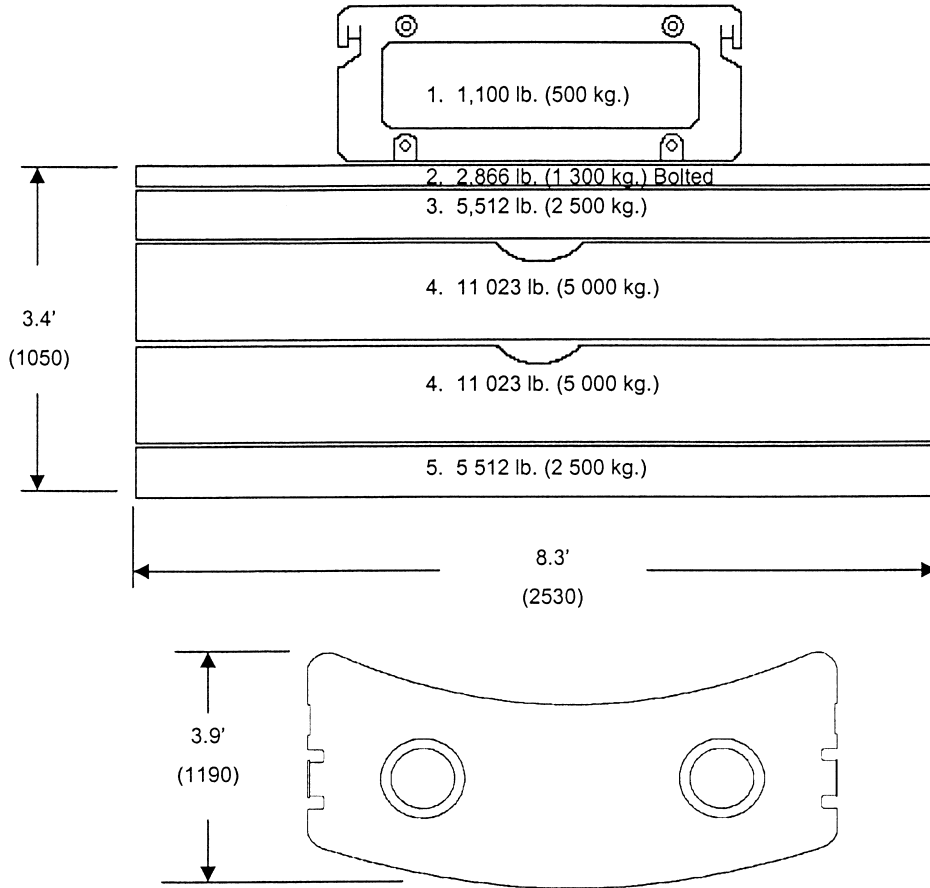

Counterweight Configurations

lb. (kg.)	1	2	3	4	5
3,900 (1 800)	x	x			
9,400 (4 300)	x	x			x
14,900 (6 800)	x	x	x		x
20,500 (9,300)	x	x		x	x
26,000 (11 800)	x	x	x	x	x
31,500 (14 300)	x	x		2x	x
37,000 (16 800)	x	x	x	2x	x

Load Chart Configuration

Counterweight	37,000 lb.	31,500 lb.	26,000 lb.	20,500 lb.	14,900 lb.	9,400 lb.	3,900 lb.
Main Boom	X■●□	X■●□	X■●□	X■●□	X■●◇□○	X■●◇□○	X■●◇□○
33 ft. Swingaway	X■●	X■●	X■●	X■	X■	X■	X■
56 ft. Swingaway	X■●	X■●	X■●	X■	X■	X■	X■
72 ft. Boom Extension	X■	X	X	X	X		
88 ft. Boom Extension	X■	X	X	X	X		

Outrigger Span 23.0 ft. = X 19.7 ft. = ■ 16.4 ft. = ● 7.6 ft. = ◇
 Rubber P&C = □ 360° = ○

GMK 4090-1

trailing boom proposal

Trailing Boom

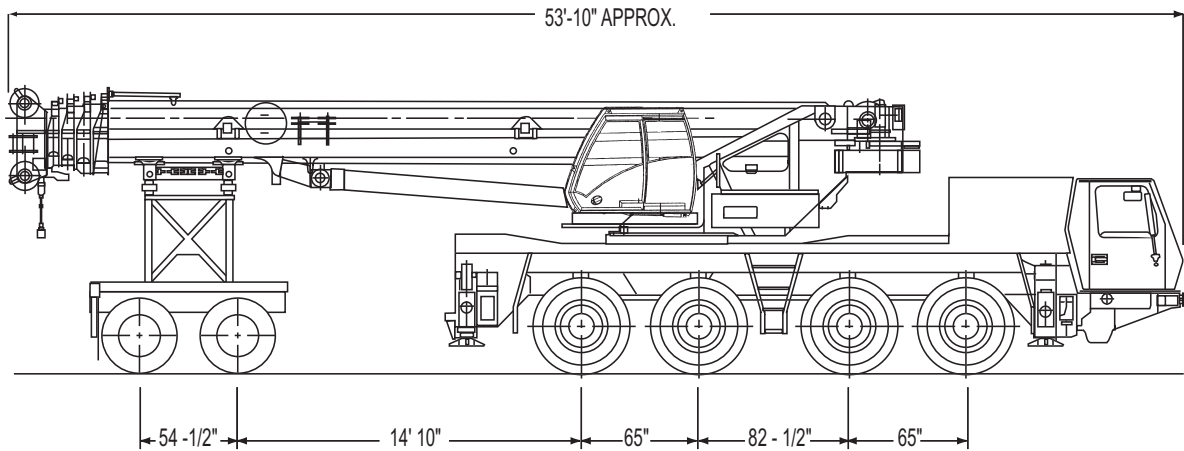

7

Dolly Axles
22,444 lbs.

Rear Axles
26,588 lbs.

Front Axles
44,787 lbs.

G.V.W.
93,819 lbs.

Unit configured as follows:

- 37-142 ft. Boom
- 1.3MT counterweight on superstructure
- 20.5 tires
- 8 x 6 x 8 Drive
- Outrigger pads on machine
- Main & auxiliary hoists with wire rope
- 33-56 ft. hydraulically offsettable swingaway
- Additional oil cooler
- 2 Axle boom dolly (5,700 lbs.)

Weights may vary due to manufacturing tolerances

THIS ILLUSTRATION IS ONLY A GUIDE. CONSULT FACTORY FOR SPECIFIC DETAILS.

GMK 4090-1

GROVE

working range

37'-141' main boom

8

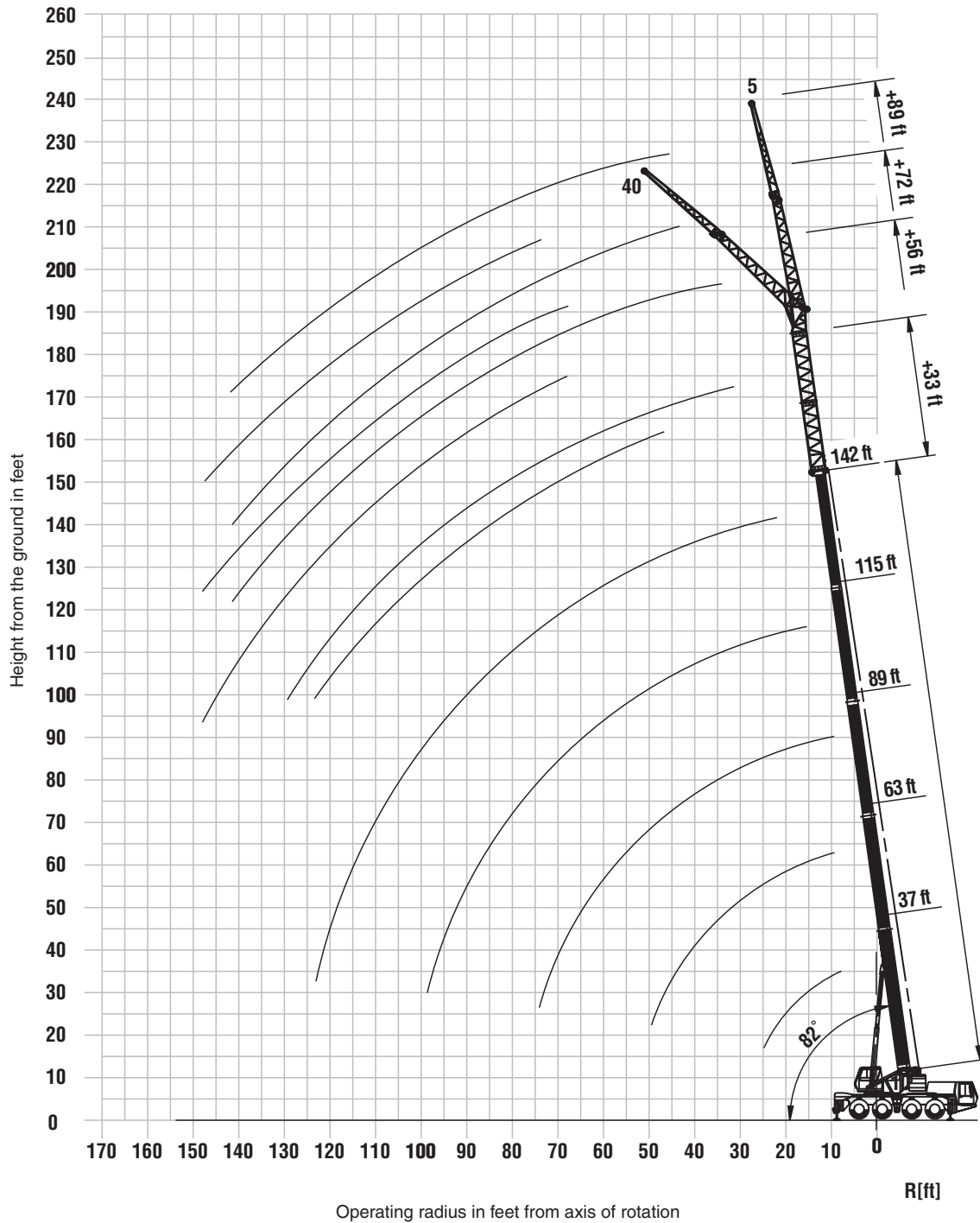

GMK 4090-1

THIS CHART IS ONLY A GUIDE AND SHOULD NOT BE USED TO OPERATE THE CRANE. The individual crane's load chart, operating instructions and other instructional plates must be read and understood prior to operating the crane.

GROVE.

load charts

 37-142 ft.
 (11.3-43.2 m)
  37,000 lb.
 (16,800 kg)
  100%
 23' Spread
  360°

Feet	Pounds (thousands)									
	37'	50'	63'	76'	89'	102'	115'	128'	142'	
8	*165.0									
9	*153.0									
10	152.0	130.0	123.0	117.0	78.0					
15	111.0	107.0	100.0	95.0	78.0	57.0				
20	89.0	88.0	85.0	80.0	77.0	54.0	40.6	32.4		
25	70.0	72.0	69.0	65.0	63.0	48.0	40.6	32.4	25.4	
30		56.0	55.0	53.0	49.0	43.6	37.8	32.4	25.4	
35		44.0	45.0	43.0	40.6	39.8	34.2	30.6	25.4	
40			36.8	36.0	34.0	34.0	30.6	28.0	25.4	
45			30.6	30.4	30.6	29.2	27.4	25.8	23.6	
50			25.8	25.8	26.8	25.2	25.0	22.6	21.8	
55				23.0	23.2	22.0	22.0	20.8	20.0	
60				20.4	20.2	19.8	19.4	18.8	17.6	
65				18.0	17.8	18.2	17.2	16.8	15.6	
70					15.6	16.0	15.4	15.0	13.8	
75					14.2	14.2	13.8	13.4	12.4	
80						12.6	12.2	12.0	11.0	
85						11.4	11.0	10.6	9.8	
90						10.2	9.8	9.4	8.8	
95							8.8	8.4	7.8	
100							7.8	7.6	6.8	
105								6.8	6.0	
110								6.0	5.2	
115								5.4	4.6	
120									4.0	
125									3.4	
130									3.0	

*Directly over the rear.
Lifting capacities greater than 127,000 lb. can only be lifted with additional equipment.

 37-142 ft.
 (11.3-43.2 m)
  20,500 lb.
 (9,300 kg)
  100%
 23' Spread
  360°

Feet	Pounds (thousands)									
	37'	50'	63'	76'	89'	102'	115'	128'	142'	
8	*165.0									
9	*153.0									
10	152.0	130.0	123.0	117.0	78.0					
15	111.0	107.0	100.0	95.0	78.0	57.0				
20	85.0	80.0	74.0	71.0	66.0	54.0	40.6	32.4		
25	59.0	59.0	56.0	53.0	50.0	48.0	40.6	32.4	25.4	
30		45.0	43.8	41.4	41.0	38.4	35.8	32.4	25.4	
35		34.6	35.4	33.6	33.6	31.4	30.8	28.8	25.4	
40			28.8	29.4	28.0	27.6	25.8	25.0	23.4	
45			24.0	25.0	23.8	23.4	22.2	21.2	19.8	
50			20.0	21.0	20.8	20.2	19.2	18.4	17.0	
55				18.0	18.0	17.6	16.6	15.8	14.6	
60				15.6	15.6	15.6	14.6	13.8	12.8	
65				13.4	13.4	13.6	12.8	12.2	11.0	
70					11.8	11.8	11.4	10.8	9.6	
75					10.2	10.4	10.0	9.4	8.4	
80						9.0	8.6	8.4	7.4	
85						8.0	7.6	7.2	6.4	
90						7.0	6.6	6.2	5.4	
95							5.6	5.4	4.6	
100							5.0	4.6	4.0	
105								4.0	3.2	
110								3.4	2.6	
115								2.8	2.0	
120										
125										
130										

*Directly over the rear.
Lifting capacities greater than 127,000 lb. can only be lifted with additional equipment.

THIS CHART IS ONLY A GUIDE AND SHOULD NOT BE USED TO OPERATE THE CRANE. The individual crane's load chart, operating instructions and other instructional plates must be read and understood prior to operating the crane.

load charts

10

37-142 ft.
(11.3-43.2 m)
 3,900 lb.
(1769 kg)
 100%
23' Spread
 360°

Feet	Pounds (thousands)								
	37'	50'	63'	76'	89'	102'	115'	128'	142'
8	*165.0								
9	*153.0								
10	152.0	130.0	123.0	112.0	78.0				
15	98.0	87.0	80.0	71.0	63.0	57.0			
20	60.0	57.0	53.0	49.0	47.0	42.6	39.4	32.4	
25	43.0	41.4	39.4	38.4	36.2	34.0	31.6	29.4	25.4
30		31.6	30.8	30.2	28.6	27.0	25.2	23.6	21.4
35		25.2	24.8	24.4	23.2	22.0	20.4	19.0	17.2
40			20.0	20.0	19.0	18.0	16.8	15.6	14.0
45			16.4	16.6	15.8	15.0	13.8	12.8	11.4
50			13.4	14.0	13.2	12.6	11.6	10.8	9.4
55				11.8	11.2	10.8	9.8	9.0	7.8
60				10.0	9.6	9.2	8.2	7.6	6.4
65				8.2	8.2	7.8	7.0	6.4	5.2
70					7.0	6.6	5.8	5.2	4.2
75					5.8	5.8	5.0	4.4	3.4
80						4.8	4.2	3.6	2.6
85						4.0	3.4	2.8	1.8
90						3.2	2.8	2.2	
95							2.2		
100									
105									
110									
115									
120									
125									
130									

*Directly over the rear.
Lifting capacities greater than 127,000 lb. can only be lifted with additional equipment.

GMK 4090-1

THIS CHART IS ONLY A GUIDE AND SHOULD NOT BE USED TO OPERATE THE CRANE. The individual crane's load chart, operating instructions and other instructional plates must be read and understood prior to operating the crane.

load charts

luffing swingaway



11

Feet	Pounds (thousands)											
	33 FT			56 FT			72 FT			89 FT		
	0°	0°-20°	20°-40°	0°	0°-20°	20°-40°	0°	0°-20°	20°-40°	0°	0°-20°	20°-40°
20												
25												
30												
35	13.8											
40	13.8			8.2								
45	13.8	13.8		8.2								
50	13.8	13.8	10.8	8.2			6.2			4.8		
55	13.8	13.8	10.8	8.2	8.0		6.2			4.8		
60	13.8	13.8	10.8	8.2	8.0		6.2	6.2		4.8		
65	13.8	13.6	10.8	8.2	8.0		6.2	6.2		4.8		
70	13.0	13.0	10.8	8.2	7.8		6.2	6.2		4.8	4.8	
75	11.6	11.6	10.8	8.2	7.4	6.2	6.2	6.2	6.0	4.8	4.8	
80	10.4	10.4	10.8	8.2	7.2	6.0	6.2	6.2	6.0	4.8	4.8	4.8
85	9.4	9.4	10.0	8.2	7.0	6.0	6.2	6.2	6.0	4.8	4.8	4.8
90	8.4	8.4	9.0	8.2	7.0	5.8	6.2	6.2	5.8	4.8	4.8	4.8
95	7.4	7.4	8.0	7.8	6.8	5.8	6.2	6.2	5.8	4.8	4.8	4.8
100	6.6	6.6	7.2	7.2	6.6	5.8	6.2	6.2	5.8	4.8	4.8	4.8
105	6.0	6.0	6.4	6.4	6.4	5.6	6.0	6.0	5.6	4.8	4.8	4.8
110	5.2	5.2	5.8	5.8	5.8	5.6	5.4	5.4	5.6	4.8	4.8	4.6
115	4.6	4.6	5.0	5.2	5.2	5.6	4.8	4.8	5.6	4.6	4.6	4.6
120	4.0	4.0	4.4	4.6	4.6	5.4	4.2	4.2	5.2	4.2	4.2	4.4
125	3.4	3.4	3.8	4.0	4.0	4.8	3.8	3.8	4.6	3.6	3.6	4.4
130	3.0	3.0	3.2	3.6	3.6	4.2	3.4	3.4	4.0	3.2	3.2	4.0
135	2.4	2.4		3.2	3.2	3.8	2.8	2.8	3.6	2.8	2.8	3.4
140	2.0	2.0		2.6	2.6	3.2	2.6	2.6	3.2	2.4	2.4	3.0
145	1.6			2.2	2.2	2.8	2.2	2.2	2.6	2.0	2.0	2.6
150	1.2			1.8	1.8	2.4	1.8	1.8	2.2	1.6	1.6	2.2



Feet	Pounds (thousands)							
	33 FT		56 FT		72 FT		89 FT	
	0°-20°	20°-40°	0°-20°	20°-40°	0°-20°	20°-40°	0°-20°	20°-40°
20								
25								
30								
35								
40								
45	13.2							
50	13.2	10.4						
55	13.0	10.4	7.6					
60	12.6	10.4	7.4					
65	12.0	10.4	7.2			6.0		
70	11.6	10.4	7.0			6.0		4.6
75	11.4	10.4	6.6	5.8		6.0	5.6	4.6
80	10.4	10.2	6.4	5.6		6.0	5.6	4.6
85	9.2	9.8	6.2	5.6		6.0	5.6	4.6
90	8.0	8.6	6.0	5.4		6.0	5.6	4.6
95	7.0	7.6	5.8	5.4		6.0	5.4	4.6
100	6.2	6.8	5.6	5.2		5.8	5.4	4.6
105	5.6	6.0	5.4	5.2		5.8	5.2	4.6
110	4.8	5.2	5.4	5.0		5.4	5.2	4.6
115	4.2	4.6	4.8	5.0		4.8	5.2	4.4
120	3.6	4.0	4.2	5.0		4.2	5.0	4.2
125	3.2	3.4	3.8	4.4		3.6	4.4	4.2
130	2.6	3.0	3.2	4.0		3.2	3.8	3.8
135	2.2		2.8	3.4		2.8	3.4	3.4
140	1.8		2.4	3.0		2.4	3.0	3.0
145			2.0	2.6		2.0	2.4	2.6
150			1.8	2.2		1.6	2.0	2.2

THIS CHART IS ONLY A GUIDE AND SHOULD NOT BE USED TO OPERATE THE CRANE. The individual crane's load chart, operating instructions and other instructional plates must be read and understood prior to operating the crane.

GMK 4090-1

load charts

luffing swingaway

12

142 ft. (43.2 m)
 33-56-72-89 ft. (10-17-22-27 m) Fixed & Intermediate Angles
 20,500 lbs. (9,300 kg)
 100% 23' Spread
 360°

Feet	Pounds (thousands)											
	33 FT			56 FT			72 FT			89 FT		
	0°	0-20°	20-40°	0°	0-20°	20-40°	0°	0-20°	20-40°	0°	0-20°	20-40°
20												
25												
30												
35	13.8											
40	13.8			8.2								
45	13.8	13.8		8.2								
50	13.8	13.8	10.8	8.2			6.2			4.8		
55	13.8	13.8	10.8	8.2	8.0		6.2			4.8		
60	12.0	12.0	10.8	8.2	8.0		6.2	6.2		4.8		
65	10.4	10.4	10.8	8.2	8.0		6.2	6.2		4.8		
70	9.0	9.0	10.0	8.2	7.8		6.2	6.2		4.8	4.8	
75	7.8	7.8	8.8	8.2	7.4	6.2	6.2	6.2	6.0	4.8	4.8	
80	6.8	6.8	7.6	7.4	7.2	6.0	6.2	6.2	6.0	4.8	4.8	4.8
85	6.0	6.0	6.6	6.4	6.4	6.0	6.0	6.0	6.0	4.8	4.8	4.8
90	5.0	5.0	5.8	5.6	5.6	5.8	5.4	5.4	5.8	4.8	4.8	4.8
95	4.4	4.4	5.0	4.8	4.8	5.8	4.6	4.6	5.8	4.4	4.4	4.8
100	3.6	3.6	4.2	4.2	4.2	5.2	4.0	4.0	5.0	3.8	3.8	4.8
105	3.0	3.0	3.6	3.6	3.6	4.6	3.4	3.4	4.4	3.2	3.2	4.2
110	2.6	2.6	3.0	3.0	3.0	4.0	2.8	2.8	3.8	2.6	2.6	3.6
115	2.0	2.0	2.4	2.6	2.6	3.4	2.4	2.4	3.2	2.2	2.2	3.2
120	1.6	1.6	2.0	2.2	2.2	2.8	1.8	1.8	2.6	1.8	1.8	2.6
125			1.4	1.6	1.6	2.4	1.4	1.4	2.2	1.4	1.4	2.2
130				1.4	1.4	2.0			1.8			1.6
135						1.6			1.4			1.2
140												
145												
150												

142 ft. (43.2 m)
 33-56-72-89 ft. (10-17-22-27 m) Loads Luffing
 20,500 lbs. (9,300 kg)
 100% 23' Spread
 360°

Feet	Pounds (thousands)							
	33 FT		56 FT		72 FT		89 FT	
	0°-20°	20°-40°	0°-20°	20°-40°	0°-20°	20°-40°	0°-20°	20°-40°
20								
25								
30								
35								
40								
45	13.2							
50	13.2	10.4						
55	13.0	10.4	7.6					
60	12.0	10.4	7.4			6.0		
65	10.4	10.4	7.2			6.0		
70	9.0	10.0	7.0			6.0	4.6	
75	7.8	8.8	6.6	5.8		6.0	5.6	4.6
80	6.8	7.6	6.4	5.6		6.0	5.6	4.6
85	6.0	6.6	6.2	5.6		6.0	5.6	4.6
90	5.0	5.8	5.6	5.4		5.4	5.6	4.6
95	4.4	5.0	4.8	5.4		4.6	5.4	4.6
100	3.6	4.2	4.2	5.2		4.0	5.0	4.6
105	3.0	3.6	3.6	4.6		3.4	4.4	4.2
110	2.4	3.0	3.0	4.0		2.8	3.8	3.6
115	2.0	2.4	2.6	3.4		2.4	3.2	3.2
120	1.4	1.8	2.2	2.8		1.8	2.6	2.6
125		1.4	1.6	2.4		1.4	2.2	2.2
130				2.0			1.8	1.6
135				1.4			1.4	1.2
140								
145								
150								

GMK 4090-1

THIS CHART IS ONLY A GUIDE AND SHOULD NOT BE USED TO OPERATE THE CRANE. The individual crane's load chart, operating instructions and other instructional plates must be read and understood prior to operating the crane.

load charts

manual offsettable swingaway

13

		Pounds (thousands)											
		33 FT			56 FT			72 FT			89 FT		
		0°	20°	40°	0°	20°	40°	0°	20°	40°	0°	20°	40°
Feet													
20													
25													
30													
35	13.8												
40	13.8				8.2								
45	13.8	13.8			8.2								
50	13.8	13.8	11.0		8.2			6.2			4.8		
55	13.8	13.8	11.0		8.2	8.0		6.2			4.8		
60	13.8	13.8	11.0		8.2	8.0		6.2	6.2		4.8		
65	13.8	13.6	11.0		8.2	8.0		6.2	6.2		4.8		
70	13.0	13.2	11.0		8.2	7.8		6.2	6.2		4.8	4.8	
75	11.6	12.4	11.0		8.2	7.4	6.2	6.2	6.2	6.0	4.8	4.8	
80	10.4	11.2	11.0		8.2	7.2	6.0	6.2	6.2	6.0	4.8	4.8	4.8
85	9.4	10.0	10.6		8.2	7.0	6.0	6.2	6.2	6.0	4.8	4.8	4.8
90	8.4	9.0	9.4		8.2	7.0	5.8	6.2	6.2	5.8	4.8	4.8	4.8
95	7.4	8.0	8.4		7.8	6.8	5.8	6.2	6.2	5.8	4.8	4.8	4.8
100	6.6	7.2	7.6		7.2	6.6	5.8	6.2	6.2	5.8	4.8	4.8	4.8
105	6.0	6.4	6.8		6.4	6.4	5.6	6.0	6.0	5.6	4.8	4.8	4.8
110	5.2	5.8	6.0		5.8	6.2	5.6	5.4	5.8	5.6	4.8	4.8	4.6
115	4.6	5.0	5.4		5.2	6.0	5.6	4.8	5.6	5.6	4.6	4.6	4.6
120	4.0	4.4	4.6		4.6	5.4	5.6	4.2	5.2	5.4	4.2	4.6	4.4
125	3.4	3.8	4.0		4.0	4.8	5.2	3.8	4.6	5.2	3.6	4.4	4.4
130	3.0	3.2	3.4		3.6	4.2	4.8	3.4	4.0	4.6	3.2	4.0	4.2
135	2.4	2.8			3.2	3.8	4.2	2.8	3.6	4.0	2.8	3.4	4.0
140	2.0	2.2			2.6	3.2	3.6	2.6	3.2	3.6	2.4	3.0	3.4
145	1.6				2.2	2.8	3.0	2.2	2.6	3.0	2.0	2.6	3.0
150	1.2				1.8	2.4	2.6	1.8	2.2	2.6	1.6	2.2	2.6
155							2.2			2.2			2.2

		Pounds (thousands)											
		33 FT			56 FT			72 FT			89 FT		
		0°	20°	40°	0°	20°	40°	0°	20°	40°	0°	20°	40°
Feet													
20													
25													
30													
35	13.8												
40	13.8				8.2								
45	13.8	13.8			8.2								
50	13.8	13.8	11.0		8.2			6.2			4.8		
55	13.8	13.8	11.0		8.2	8.0		6.2			4.8		
60	12.0	13.0	11.0		8.2	8.0		6.2	6.2		4.8		
65	10.4	11.4	11.0		8.2	8.0		6.2	6.2		4.8		
70	9.0	10.0	10.8		8.2	7.8		6.2	6.2		4.8	4.8	
75	7.8	8.8	9.4		8.2	7.4	6.2	6.2	6.2	6.0	4.8	4.8	
80	6.8	7.6	8.2		7.4	7.2	6.0	6.2	6.2	6.0	4.8	4.8	4.8
85	6.0	6.6	7.2		6.4	7.0	6.0	6.0	6.2	6.0	4.8	4.8	4.8
90	5.0	5.8	6.2		5.6	6.8	5.8	5.4	6.2	5.8	4.8	4.8	4.8
95	4.4	5.0	5.4		4.8	6.0	5.8	4.6	5.8	5.8	4.4	4.8	4.8
100	3.6	4.2	4.6		4.2	5.2	5.8	4.0	5.0	5.8	3.8	4.8	4.8
105	3.0	3.6	4.0		3.6	4.6	5.4	3.4	4.4	5.2	3.2	4.2	4.8
110	2.6	3.0	3.2		3.0	4.0	4.6	2.8	3.8	4.6	2.6	3.6	4.4
115	2.0	2.4	2.6		2.6	3.4	4.0	2.4	3.2	3.8	2.2	3.2	3.8
120	1.6	2.0	2.2		2.2	2.8	3.4	1.8	2.6	3.4	1.8	2.6	3.2
125		1.4	1.6		1.6	2.4	3.0	1.4	2.2	2.8	1.4	2.2	2.8
130					1.4	2.0	2.4		1.8	2.2		1.6	2.2
135						1.6	2.0		1.4	1.8		1.2	1.8
140							1.4			1.4			1.4
145													
150													

GMK 4090-1

THIS CHART IS ONLY A GUIDE AND SHOULD NOT BE USED TO OPERATE THE CRANE. The individual crane's load chart, operating instructions and other instructional plates must be read and understood prior to operating the crane.

rated lifting capacities

14

IMPORTANT NOTES:

WARNING: THIS CHART IS ONLY A GUIDE.

The notes below are for illustration only and should not be relied upon to operate the crane. The individual crane's load chart, operating instructions and other instruction plates must be read and understood prior to operating the crane.

1. All rated loads meet ANSI/ASME B30.5, Mobile and Locomotive Cranes. Testing and development were performed to SAEJ1063, Cantilevered Boom Crane Structures - Method of Test and SAEJ765 Crane Stability Test Code.

































2. Capacities given do not include the weight of hook blocks, slings, auxiliary lifting equipment and load handling devices. Their weights must be added to the load to be lifted. When more than minimum required reeving is used, the additional rope weight shall be considered part of the load.

3. The machine shall be leveled on a firm supporting surface. Depending on the nature of the supporting surface, it may be necessary to have structural supports under the outrigger floats to spread the load to a larger bearing surface.

4. When either boom length or radius or both are between values listed, the smallest load shown at either the next larger radius or next longer or shorter boom length shall be used.

5. For outrigger operation, outriggers shall be properly extended with tires raised off the ground before operating the boom or lifting loads.

Symbols Glossary

	Frame		Steering
	Outriggers		Transmission
	Outrigger Controls		Axles
	Engine		Brakes
	Fuel Tank Capacity		Tires
	Electrical System		Suspension
	Drive		Rotation
	Lights		Boom Elevation
	Cab		Swing
	Boom		Counterweight
	Boom Nose		Oil
	Boom Extension		Hydraulic System
	Speed		Hoist
	Grade		Radius
	Extension		Boom Length
	Gear		Hookblock



Manitowoc Crane Group - Americas

Manitowoc, Wisconsin Facility
Tel: [Int + 001] 920 684 6621
Fax: [Int + 001] 920 683 6277
Shady Grove, Pennsylvania Facility
Tel: [Int + 001] 717 597 8121
Fax: [Int + 001] 717 597 4062

Manitowoc Crane Group - EMEA

Europe Middle East & Africa
Tel: [Int + 33] (0) 191 565 6281
Fax: [Int + 33] (0) 4 72 18 20 20

Manitowoc Crane Group - UK

Europe Middle East & Africa
Tel: [Int + 44] (0) 191 565 6281
Fax: [Int + 44] (0) 191 564 0442

Manitowoc Crane Group - Germany

(Sales, Parts & Service)
Tel: [Int + 49](0) 2173 8909 0
Fax: [Int + 49] (0) 2173 8909-30

Manitowoc Crane Group - France

France & Africa (Sales, Parts & Service)
Tel: [Int + 33] (0) 1 303 13150
Fax: [Int + 33] (0) 1 303 86085

Manitowoc Crane Group - Netherlands

(Sales, Parts & Service)
Tel: [Int + 31] (0) 76 578 39 99
Fax: [Int + 31] (0) 76 578 39 78

Manitowoc Crane Group - Italy

Italy & Southern Europe (Sales, Parts & Service)
Tel: [Int + 39] (0) 331 49 33 11
Fax: [Int + 39] (0) 331 49 33 30

Manitowoc Crane Group - Portugal

Portugal & Spain (Sales, Parts & Service)
Tel: [Int + 351] (0) 22 968 08 89
Fax: [Int + 351] (0) 22 968 08 97

Manitowoc Crane Group - Singapore

Asia/Pacific excl China (Sales, Parts & Service)
Tel: [Int + 65] 6861 1733
Fax: [Int + 65] 6862 4040 / 4142

Manitowoc Crane Group - Shanghai

China (Sales, Parts & Service)
Tel: [Int + 86] (0) 21 64955555
Fax: [Int + 86] (0) 2164852038

Manitowoc Crane Group - Beijing

China (Sales, Parts & Service)
Tel: [Int + 86] (0) 10 646 71690
Fax: [Int + 86] (0) 10 646 71691

Manitowoc Crane Group - Middle East

(Sales)
Tel: [Int + 971] (0) 4 348 4478
Fax: [Int + 971] (0) 4 348 4478
(Parts & Service)
Tel: [Int + 973] (0) 9 660 899
Fax: [Int + 973] (0) 2 707 740

Distributed By:



www.manitowoccrane.com



Constant improvement and engineering progress make it necessary that we reserve the right to make specification, equipment, and price changes without notice. Illustrations shown may include optional equipment and accessories, and may not include all standard equipment.