

POTAIN

MCR 225

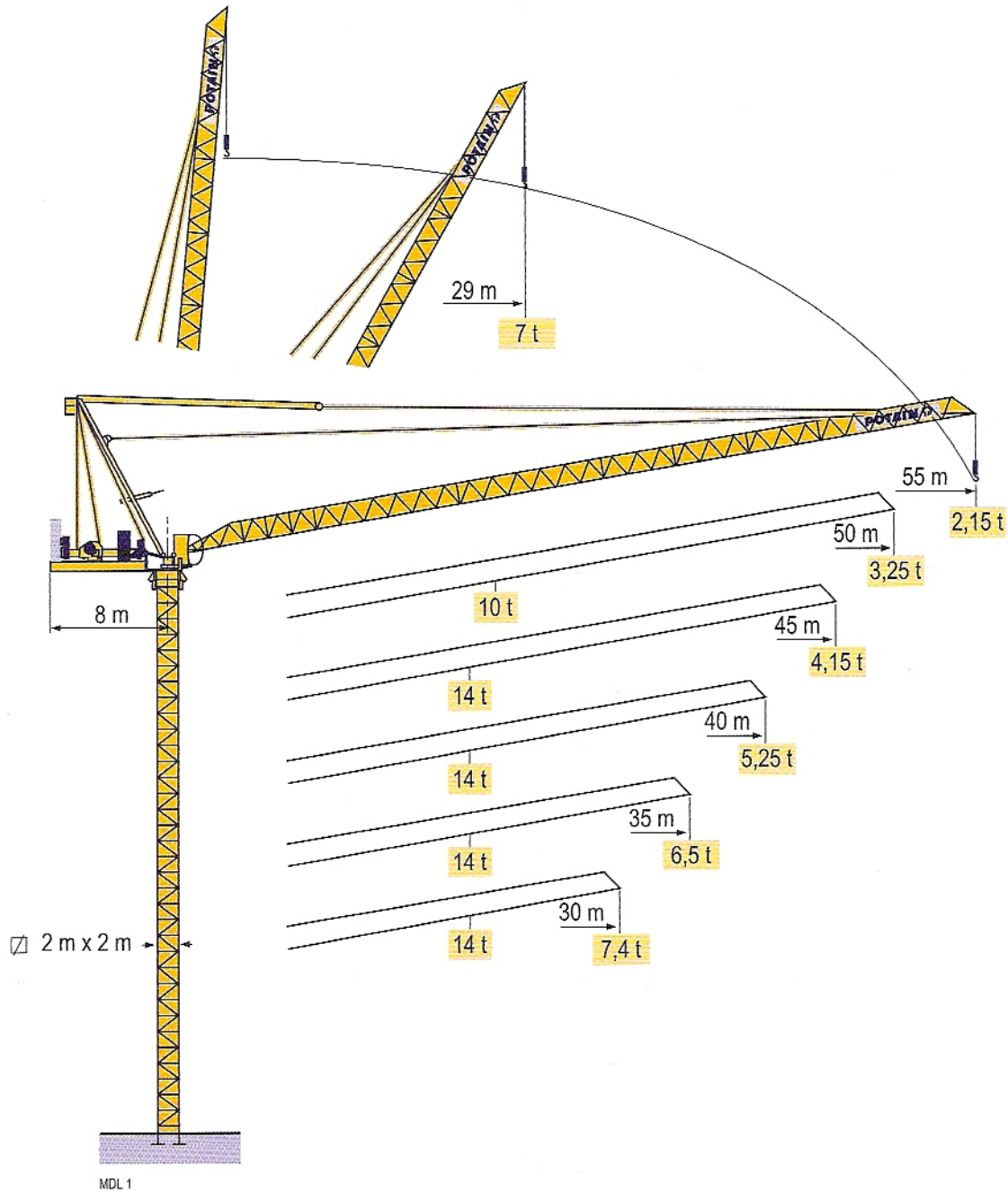

Masts / Reactions

NDL 1

Telescopic 2 m

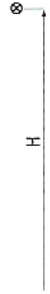
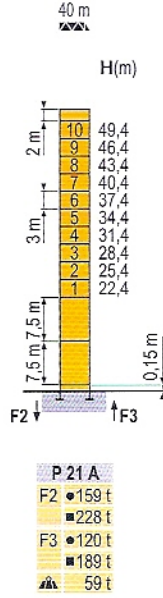
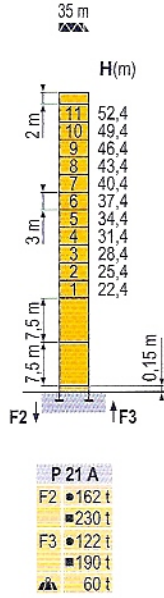
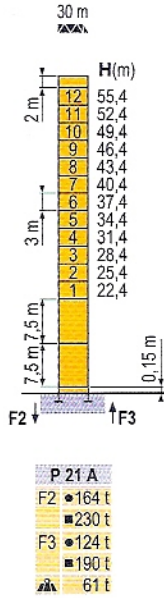

Telescopic 2 m

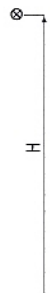
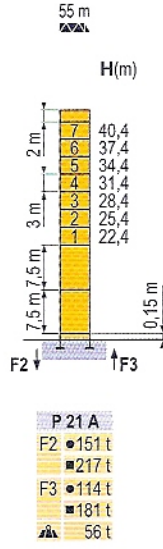
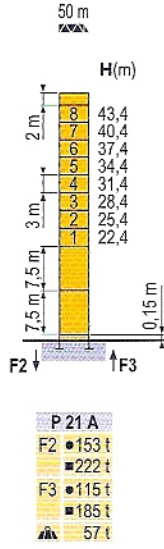
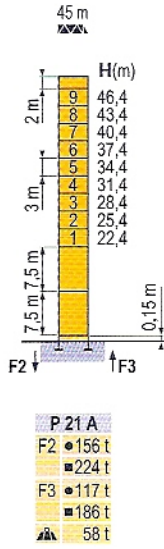

MCR 225

POTAIN



- Reactions in service
- Reactions out of service
- ▲ Without load, ballast (or transport axles), with maximum jib and maximum height.

Load diagrams

MCR 1

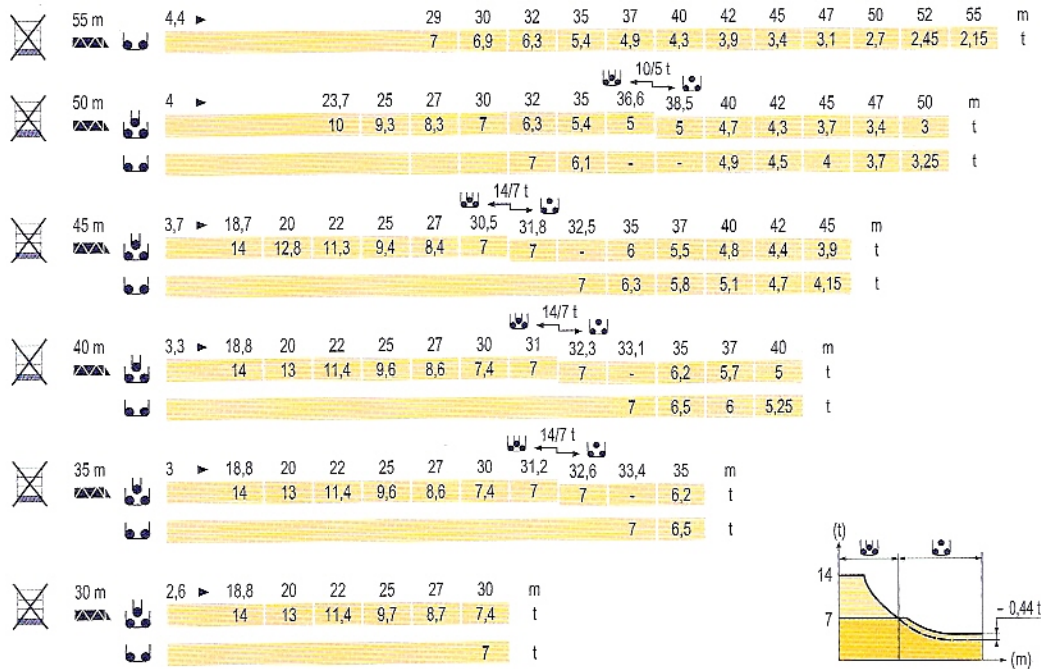

= - 0,1 t

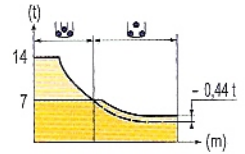

Luffing jib

MCR 1

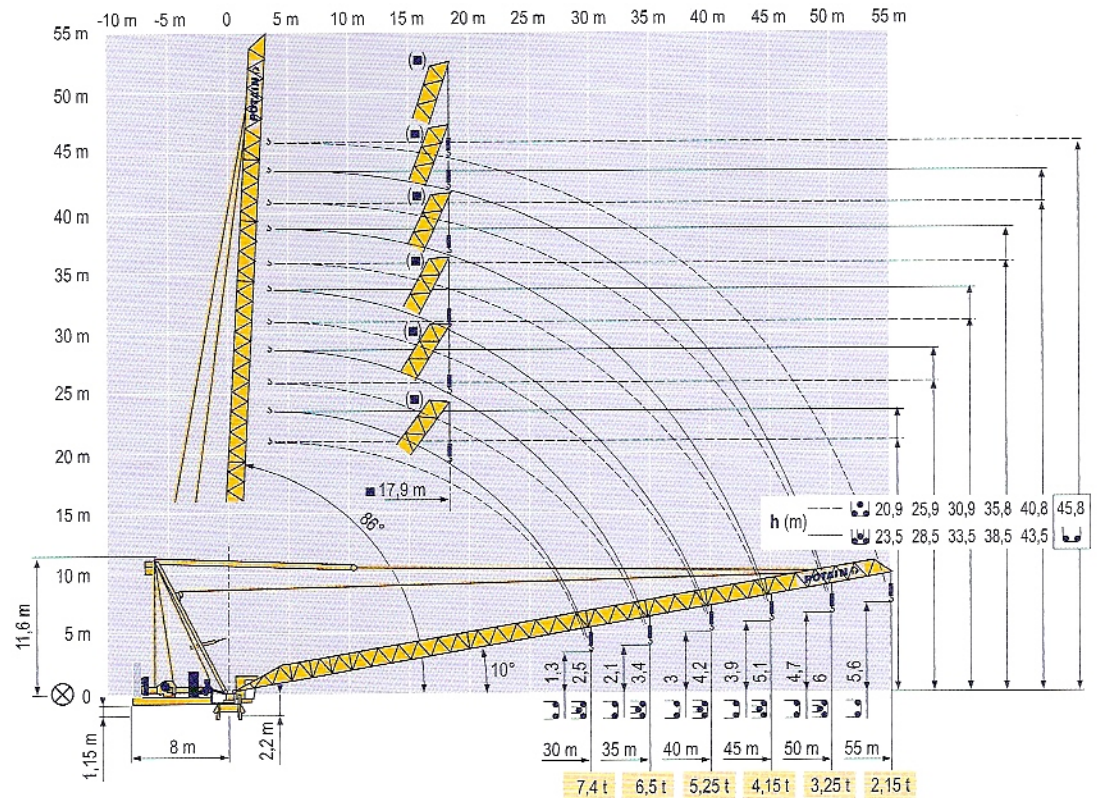

MCR 225

POTAIN



Load diagrams without jib-end inspection platform



Load diagrams with jib-end inspection platform deduct 0,1 t



Jib hinge shaft



Weathervaning position

Mechanisms

MDL 1

MCR 225 - 50 Hz													hp	kW									
	75 LVF 35	m/min	0	→	40	→	46	→	81	→	96	0	→	20	→	23	→	41	→	48	75	55	766 m
	Optima	t	7		6		3		2,25	14		12		6		4,5							
	75 VBR 30	m/min	2 min															75	55				
	RCV 185	rpm	0 → 0,71															2 x 9	2 x 6,6				
CEI 38			IEC 38												kVA								
400 V (+6% -10%)															75 LVF : 160 kVA								

MCR 225 - 60 Hz													hp	kW									
	75 LVF 35	m/min	0	→	40	→	46	→	81	→	96	0	→	20	→	23	→	41	→	48	75	55	766 m
	Optima	t	7		6		3		2,25	14		12		6		4,5							
	75 VBR 30	m/min	1min 40 s															90	66				
	RCV 185	rpm	0 → 0,84															2 x 10,8	2 x 8				
CEI 38			IEC 38												kVA								
480 V (+6% -10%)															75 LVF : 180 kVA								



- Hoisting
- Luffing
- Slewing



This commercial document is not legally binding.
For any technical information, please refer to the corresponding instructions.

Manitowoc
Crane CARE

Manitowoc
Crane Group

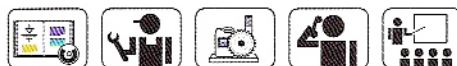

Americas
Tel : +1 888 479 7278
Tel : +1 717 593 2000

Europe - Middle East - Africa
Tel : +33 (0) 4 72 81 50 00
Tel : +44 (0) 191 522 2000

Asia - Pacific
Tel : +65 6264 1188
Fax : +65 6862 4142

www.manitowoccrane.com

Manitowoc Crane Group Asia Pte Ltd
Manitowoc Crane Group
4 Kwong Min Road
Singapore 628707

Tel: +65 6264 1188
Fax: +65 6862 4040
www.manitowoccrane.com

MCR 225
Réf. 2006 06 MDL 1

Copyright.Reproduction interdite © POTAIN 2006

Réalisation Sedoc