

MAIN BOOM LIFTING CAPACITY

(Counterweight: 48.0 t, Without Carbody Weight)

Unit: Metric tons

Boom length m (ft)	15.2	18.3	21.3	24.4	27.4	30.5	33.5	36.6	39.6	42.7	45.7	48.8	51.8	54.9	57.9	61.0	64.0	67.1	70.1	73.2	76.2	
4.5	4.5 m/135.0																					
5.0	121.0	5.1 m/120.5	5.6 m/114.7																			
6.0	106.4	107.7	105.3	6.1 m/97.8	6.7 m/84.9																	
7.0	91.9	90.6	86.9	83.3	80.1	7.2 m/74.9	7.7 m/66.9															
8.0	73.8	73.7	73.7	71.1	68.6	66.4	64.3	8.2 m/60.2	8.8 m/54.7													
9.0	61.6	61.4	61.4	61.2	59.9	58.1	56.5	54.7	53.2	9.3 m/49.9	9.8 m/45.8											
10.0	52.7	52.6	52.5	52.3	52.2	51.6	50.3	48.8	47.5	46.2	45.0	10.4 m/42.2	10.9 m/39.0	11.4 m/36.3	11.9 m/33.8							
12.0	40.8	40.6	40.5	40.3	40.2	40.1	40.0	39.8	38.9	37.9	37.0	36.1	35.2	34.4	33.6	12.5 m/31.4	13.0 m/29.2	13.5 m/26.7				
14.0	33.1	32.9	32.8	32.6	32.4	32.4	32.3	32.1	32.0	31.9	31.3	30.5	29.8	29.1	28.4	27.7	27.0	26.5	14.1 m/25.8	14.6 m/24.1	15.1 m/20.4	
16.0	14.8 m/29.3	27.6	27.5	27.3	27.1	27.0	26.9	26.7	26.6	26.5	26.4	26.2	25.6	25.1	24.5	23.9	23.2	22.9	22.3	21.7	19.4	
18.0		17.5 m/24.6	23.5	23.3	23.1	23.0	22.9	22.7	22.6	22.5	22.4	22.2	22.1	21.9	21.3	20.8	20.2	19.9	19.4	18.9	17.5	
20.0			20.6	20.3	20.1	20.0	19.9	19.7	19.6	19.4	19.3	19.2	19.0	18.9	18.8	18.3	17.8	17.5	17.1	16.6	15.8	
22.0			20.1 m/20.4	17.9	17.7	17.6	17.5	17.3	17.2	17.0	16.9	16.7	16.6	16.5	16.3	16.2	15.8	15.5	15.1	14.6	14.2	
24.0				22.8 m/17.2	15.8	15.7	15.5	15.3	15.2	15.1	14.9	14.8	14.6	14.5	14.4	14.2	14.0	13.8	13.4	13.0	12.6	
26.0					25.4 m/14.7	14.1	13.9	13.7	13.6	13.5	13.3	13.2	13.0	12.9	12.7	12.6	12.4	12.4	12.0	11.6	11.2	
28.0						12.8	12.6	12.4	12.2	12.1	12.0	11.8	11.6	11.5	11.4	11.2	11.0	11.0	10.8	10.4	10.0	
30.0						28.1 m/12.7	11.5	11.2	11.1	10.9	10.8	10.6	10.5	10.4	10.2	10.0	9.8	9.8	9.6	9.3	9.0	
32.0							30.7 m/11.1	10.2	10.1	10.0	9.8	9.6	9.5	9.4	9.2	9.0	8.8	8.8	8.6	8.3	8.0	
34.0								9.3	9.1	8.9	8.8	8.6	8.5	8.3	8.1	8.0	7.9	7.7	7.5	7.2		
36.0									8.5	8.3	8.2	8.0	7.8	7.7	7.5	7.4	7.2	7.1	7.0	6.7	6.4	
38.0										7.7	7.5	7.3	7.2	7.0	6.9	6.7	6.5	6.5	6.3	6.0	5.8	
40.0											38.6 m/7.5	6.9	6.7	6.6	6.4	6.3	6.1	5.9	5.8	5.6	5.4	5.2
42.0												41.2 m/6.6	6.2	6.0	5.9	5.7	5.5	5.3	5.2	5.0	4.8	4.6
44.0													43.9 m/5.8	5.6	5.4	5.2	5.0	4.7	4.7	4.5	4.2	4.0
46.0														5.1	4.9	4.7	4.5	4.2	4.2	4.0	3.7	3.6
48.0														46.5 m/5.0	4.5	4.3	4.1	3.8	3.7	3.5	3.3	3.1
50.0															49.2 m/4.2	3.9	3.7	3.4	3.3	3.1	2.9	2.7
52.0																51.8 m/3.5	3.3	3.1	3.0	2.8	2.5	2.3
54.0																	3.0	2.7	2.6	2.4	2.2	
56.0																	54.4 m/2.9	2.4	2.3	2.1		
58.0																		57.1 m/2.3	2.0			
reeves	10	9	9	8	7	6	5	5	5	4	4	4	3	3	3	3	3	2	2	2	2	2

Note: Ratings according to DIN 15018/3 and prEN 13000.
Ratings shown in are determined by the strength of the boom or other structural components.

MAIN BOOM LIFTING CAPACITY

(Counterweight: 53.0 t, Carbody Weight: 10.0 t)

Unit: Metric tons

Boom length m (ft)	15.2	18.3	21.3	24.4	27.4	30.5	33.5	36.6	39.6	42.7	45.7	48.8	51.8	54.9	57.9	61.0	64.0	67.1	70.1	73.2	76.2	
4.5	4.5 m/135.0																					
5.0	131.1	5.1 m/128.4	5.6 m/117.2																			
6.0	110.4	110.1	109.6	6.1 m/107.8	6.7 m/95.1																	
7.0	95.1	94.8	93.3	91.1	89.3	7.2 m/84.2	7.7 m/75.3															
8.0	79.5	79.9	79.1	77.4	75.9	74.6	72.4	8.2 m/67.8	8.8 m/61.7													
9.0	67.7	68.8	68.5	67.2	66.0	64.9	62.5	61.5	60.0	9.3 m/56.3	9.8 m/51.8											
10.0	58.4	59.0	59.0	58.8	58.3	57.4	56.5	55.0	53.6	52.2	50.9	10.4 m/47.8	10.9 m/44.2	11.4 m/40.1	11.9 m/38.4							
12.0	44.3	45.7	45.6	45.4	45.2	45.2	45.1	44.9	44.1	43.0	42.0	41.0	40.0	39.1	38.2	12.5 m/35.8	13.0 m/33.4	13.5 m/26.7				
14.0	33.5	37.1	37.0	36.8	36.6	36.5	36.5	36.3	36.2	36.1	35.6	34.7	33.9	33.2	32.5	31.7	30.9	26.7	14.1 m/26.7	14.6 m/24.4	15.1 m/20.4	
16.0	14.8 m/29.3	30.0	31.0	30.8	30.6	30.5	30.4	30.2	30.1	30.0	29.9	29.8	29.3	28.7	28.1	27.4	26.7	26.3	25.7	22.7	19.4	
18.0		17.5 m/24.8	26.6	26.4	26.2	26.1	26.0	25.8	25.7	25.6	25.4	25.3	25.2	25.1	24.6	24.0	23.4	23.0	22.5	20.6	17.5	
20.0			21.7	23.0	22.8	22.7	22.6	22.4	22.3	22.2	22.0	21.9	21.7	21.6	21.5	21.2	20.7	20.4	19.9	18.8	15.8	
22.0			20.1 m/21.3	19.9	20.1	20.0	19.9	19.7	19.6	19.5	19.3	19.2	19.0	18.9	18.8	18.6	18.4	18.1	17.7	17.1	14.3	
24.0				22.8 m/18.5	18.0	17.9	17.7	17.5	17.4	17.3	17.1	17.0	16.8	16.7	16.6	16.4	16.2	16.2	15.8	15.4	13.0	
26.0					25.4 m/16.0	16.1	16.0	15.7	15.6	15.5	15.3	15.2	15.0	14.9	14.7	14.6	14.4	14.4	14.2	13.8	11.8	
28.0						14.2	14.5	14.2	14.1	13.9	13.8	13.6	13.5	13.4	13.2	13.1	12.9	12.8	12.7	12.4	10.7	
30.0						28.1 m/14.1	13.2	12.9	12.8	12.7	12.5	12.3	12.2	12.1	11.9	11.7	11.6	11.5	11.4	11.2	9.7	
32.0							30.7 m/12.5	11.8	11.7	11.5	11.4	11.2	11.1	10.9	10.8	10.6	10.4	10.4	10.2	10.0	8.8	
34.0								33.3 m/10.9	10.8	10.6	10.4	10.3	10.1	10.0	9.8	9.6	9.4	9.4	9.2	9.1	8.0	
36.0									9.7	9.8	9.6	9.4	9.2	9.1	8.9	8.8	8.6	8.5	8.4	8.2	7.2	
38.0										8.9	8.8	8.7	8.5	8.4	8.2	8.0	7.8	7.8	7.6	7.4	6.5	
40.0										38.6 m/8.6	8.1	8.0	7.8	7.7	7.5	7.3	7.1	7.1	6.9	6.7	5.8	
42.0											41.2 m/7.5	7.4	7.2	7.1	6.9	6.7	6.5	6.5	6.3	6.1	5.2	
44.0												43.9 m/6.5	6.7	6.5	6.4	6.2	6.0	5.9	5.7	5.5	4.6	
46.0													5.9	6.0	5.9	5.7	5.4	5.3	5.2	4.9	4.0	
48.0													46.5 m/5.7	5.3	5.4	5.2	4.9	4.9	4.7	4.4	3.5	
50.0														49.2 m/4.8	4.7	4.7	4.5	4.4	4.2	4.0	2.9	
52.0															51.8 m/4.1	4.2	4.1	4.0	3.8	3.6	2.4	

WORKING RADIUS & BOOM ARRANGEMENT

WORKING RADIUS

(Counterweight: 53.0 t, Carbody Weight: 10.0 t)

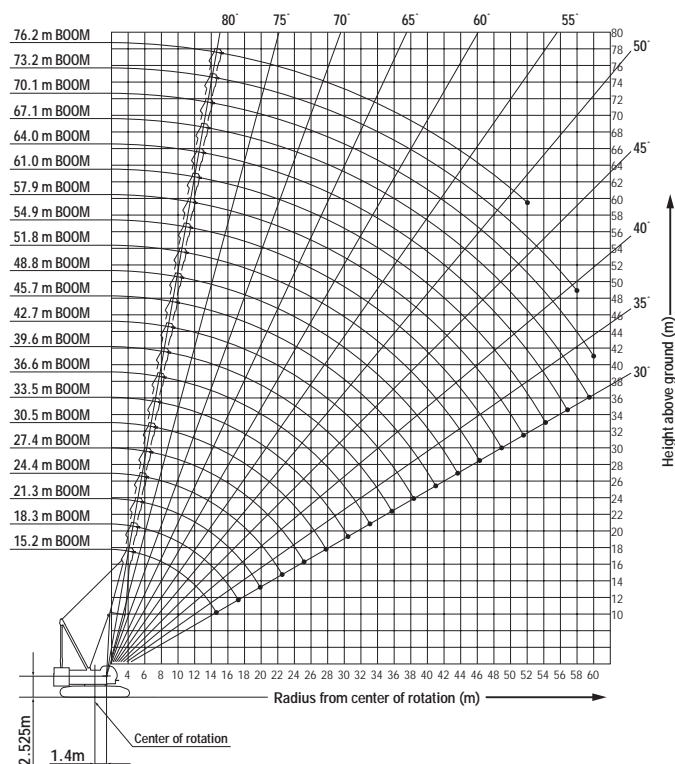

BOOM ARRANGEMENT CHART

Boom length (m)	Boom arrangement
15.2	Base-Tip
18.3	Base-A-Tip
21.3	Base-B-Tip
24.4	Base-A-B-Tip
27.4	Base-A-A-B-Tip
30.5	Base-A-A-C-Tip
33.5	Base-A-B-C-Tip
36.6	Base-A-A-B-C-Tip
39.6	Base-A-B-B-C-Tip
42.7	Base-A-B-C-C-Tip
45.7	Base-A-A-B-C-C-Tip
48.8	Base-A-B-B-C-C-Tip
51.8	Base-A-B-C-C-C-Tip
54.9	Base-A-A-B-C-C-C-Tip
57.9	Base-A-B-B-C-C-C-Tip
61.0	Base-A-B-C-C-C-C-Tip
64.0	Base-A-A-B-C-C-C-C-Tip
67.0	Base-A-B-B-C-C-C-C-Tip
70.1	Base-A-B-C-C-C-C-C-Tip
73.2	Base-A-A-B-C-C-C-C-C-Tip
76.2	Base-A-B-B-C-C-C-C-C-Tip

Base = 7.6 m, Tip Section = 4.6 m Boom tip + 3.0 m tapered boom
 Inserts: A = 3.0 m, B = 6.1 m, C = 9.1 m

WORKING RADIUS (Jib Offset Angle: 10°)

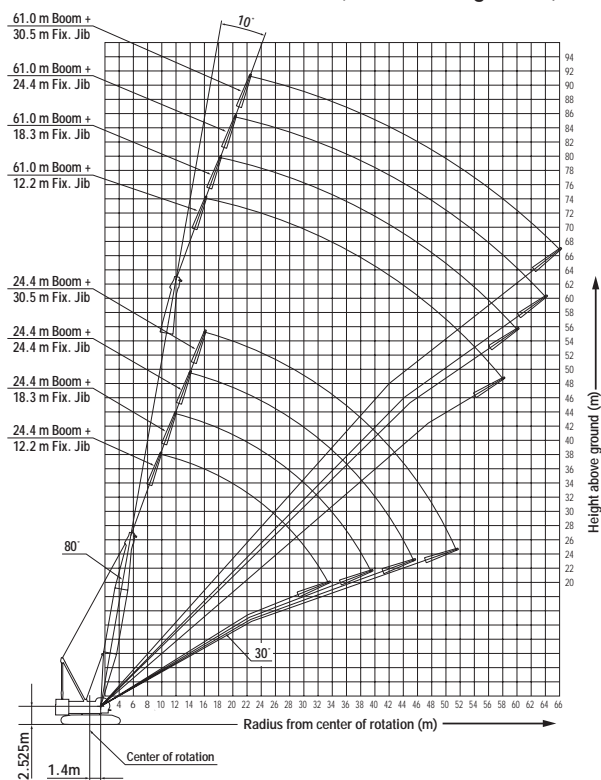

WORKING RADIUS (Jib Offset Angle: 30°)

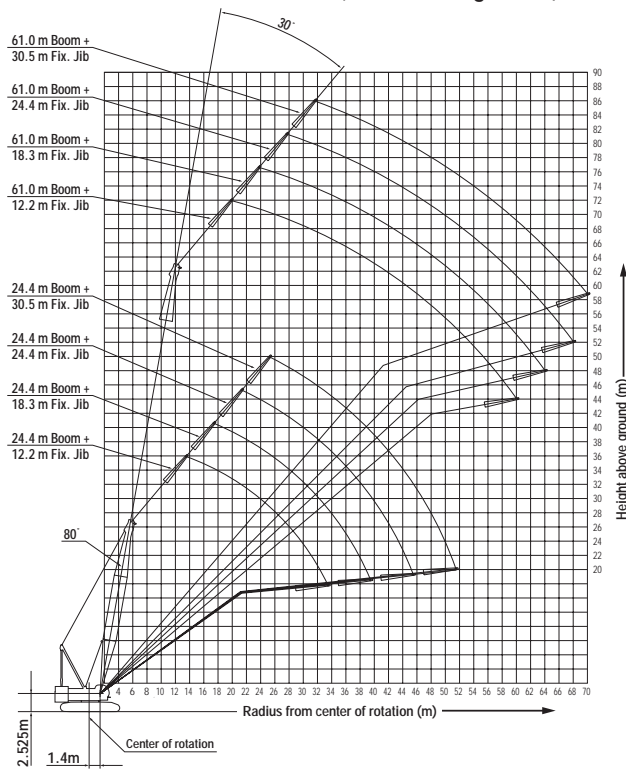

FIXED JIB ARRANGEMENT

Jib length (m)	Jib arrangement
12.2	Base-A-Jib Tip
18.3	Base-A-B-Jib Tip
24.4	Base-A-B-B-Jib Tip
30.5	Base-A-B-B-B-Jib Tip

Base = 4.6 m, Jib Tip Section = 4.6 m
 Jib Insert: A = 3.0 m, B = 6.1 m

FIXED JIB LIFTING CAPACITY

(Counterweight: 53.0 t, Carbody Weight: 10.0 t, without main hook)

Jib Offset Angle: 10°

Unit: Metric tons

Boom length		24.4 m				33.5 m				39.6 m			
Jib length	12.2 m	18.3 m	24.4 m	30.5 m	12.2 m	18.3 m	24.4 m	30.5 m	12.2 m	18.3 m	24.4 m	30.5 m	
Working radius	9.0 m	9.9/26.8											
	10.0 m	26.8			11.5/26.8								
	12.0 m	26.7	19.2		26.8	13.5/19.2			12.5/26.8				
	14.0 m	25.8	18.9	14.3/9.9		26.8	19.1	15.9/9.9		26.8	14.6/19.2		
	16.0 m	24.9	18.3	9.7	16.4/5.9	26.0	18.8	9.9	6.0	26.5	19.0	17.0/9.9	
	18.0 m	24.1	17.7	9.5	5.8	25.3	18.4	9.7	5.9	25.8	18.7	9.8	19.1/5.9
	20.0 m	22.9	16.8	9.2	5.6	23.0	17.9	9.5	5.7	22.7	18.3	9.6	5.8
	22.0 m	20.8	15.2	8.8	5.3	20.3	17.4	9.3	5.6	20.0	17.8	9.5	5.7
	24.0 m	18.6	13.9	8.4	5.0	18.1	16.4	9.0	5.4	17.7	17.4	9.3	5.6
	26.0 m	16.8	12.8	8.0	4.8	16.2	15.1	8.6	5.1	15.9	16.1	9.0	5.4
	28.0 m	15.2	11.9	7.7	4.5	14.7	14.0	8.3	4.9	14.3	14.6	8.7	5.1
	30.0 m	13.9	11.1	7.4	4.3	13.4	13.1	8.0	4.7	13.0	13.2	8.4	4.9
	32.0 m	12.8	10.4	7.2	4.2	12.3	12.3	7.7	4.5	11.9	12.1	8.1	4.7
	34.0 m	11.2	9.7	6.9	4.0	11.3	11.5	7.5	4.3	10.9	11.1	7.8	4.6
	36.0 m		9.2	6.7	3.8	10.4	10.6	7.3	4.2	10.0	10.2	7.6	4.4
	38.0 m		8.7	6.5	3.7	9.7	9.8	7.1	4.0	9.3	9.5	7.4	4.2
	40.0 m		8.3	6.3	3.5	8.9	9.1	6.9	3.9	8.6	8.8	7.2	4.1
	42.0 m			6.2	3.4	7.8	8.5	6.7	3.8	8.0	8.1	7.0	4.0
	44.0 m			6.1	3.3		8.0	6.5	3.6	7.4	7.6	6.8	3.8
	46.0 m			6.0	3.2		7.3	6.4	3.5	6.5	7.1	6.7	3.7
	48.0 m				3.1		6.4	6.3	3.4		6.6	6.5	3.6
	50.0 m				3.1			6.1	3.3		6.0	6.4	3.5
	52.0 m							6.0	3.2		5.4	6.0	3.4
	54.0 m							5.4	3.2			5.7	3.3
56.0 m								3.1			5.1	3.3	
58.0 m								3.0			4.5	3.2	
60.0 m								2.9				3.1	
62.0 m												3.1	
64.0 m												3.0	

Boom length		45.7 m				51.8 m				61.0 m			
Jib length	12.2 m	18.3 m	24.4 m	30.5 m	12.2 m	18.3 m	24.4 m	30.5 m	12.2 m	18.3 m	24.4 m	30.5 m	
Working radius	12.0 m	13.6/26.8											
	14.0 m	26.8	15.7/19.1			14.6/26.8							
	16.0 m	26.8	19.1			26.8	16.7/19.1			16.2/21.2			
	18.0 m	25.8	18.9	9.9		25.6	19.0	19.1/9.9		20.7	18.3/19.1		
	20.0 m	22.4	18.6	9.7	20.1/5.9	22.1	18.8	9.8	21.2/5.9	20.3	18.9	20.7/9.9	
	22.0 m	19.6	18.1	9.6	5.8	19.3	18.4	9.6	5.8	18.7	18.7	9.8	22.8/5.9
	24.0 m	17.4	17.6	9.4	5.7	17.1	17.4	9.5	5.7	16.6	16.7	9.6	5.8
	26.0 m	15.5	15.8	9.3	5.5	15.2	15.5	9.4	5.6	14.8	14.9	9.5	5.7
	28.0 m	14.0	14.2	9.0	5.3	13.7	13.9	9.2	5.5	13.2	13.4	9.4	5.6
	30.0 m	12.7	12.9	8.7	5.1	12.4	12.6	8.9	5.3	11.9	12.1	9.3	5.5
	32.0 m	11.5	11.7	8.4	4.9	11.2	11.5	8.7	5.1	10.7	11.0	9.1	5.3
	34.0 m	10.5	10.7	8.1	4.7	10.2	10.4	8.4	4.9	9.7	10.0	8.8	5.2
	36.0 m	9.7	9.9	7.9	4.6	9.3	9.6	8.2	4.8	8.8	9.1	8.6	5.0
	38.0 m	8.9	9.1	7.7	4.4	8.6	8.8	8.0	4.6	8.1	8.3	8.4	4.9
	40.0 m	8.2	8.4	7.5	4.3	7.9	8.1	7.8	4.5	7.4	7.6	7.9	4.7
	42.0 m	7.6	7.8	7.3	4.2	7.3	7.5	7.6	4.3	6.7	7.0	7.3	4.6
	44.0 m	7.0	7.2	7.1	4.0	6.7	6.9	7.2	4.2	6.2	6.4	6.7	4.4
	46.0 m	6.5	6.7	7.0	3.9	6.2	6.4	6.7	4.1	5.6	5.9	6.2	4.3
	48.0 m	5.9	6.2	6.5	3.8	5.7	5.9	6.2	4.0	5.1	5.3	5.7	4.2
	50.0 m	5.3	5.8	6.1	3.7	5.2	5.5	5.8	3.9	4.6	4.9	5.3	4.1
	52.0 m	4.6	5.3	5.7	3.6	4.7	5.1	5.4	3.8	4.1	4.4	4.9	4.0
	54.0 m		4.8	5.3	3.5	4.1	4.6	5.0	3.7	3.7	4.0	4.5	3.9
	56.0 m		4.3	5.0	3.4	3.6	4.2	4.7	3.6	3.3	3.6	4.1	3.8
	58.0 m		3.7	4.5	3.3	3.1	3.7	4.3	3.5	2.8	3.2	3.7	3.7
60.0 m			4.1	3.3		3.3	3.9	3.4		2.8	3.3	3.5	
62.0 m			3.6	3.2		2.9	3.5	3.3			3.0	3.1	
64.0 m			3.2	3.1		2.4	3.1	3.3			2.7	2.8	
66.0 m				3.1			2.8	3.1				2.5	
68.0 m				2.9			2.4	2.8					
70.0 m				2.5				2.4					

Note: 1. Rating according to DIN 15018/3 and prEN 13000.

2. Rating shown in [] are determined by the strength of the boom or other structural components.

3. The own weight of all load carrying devices of main boom tackle must be subtracted from the capacity of the offset jib at radius.

FIXED JIB LIFTING CAPACITY

CKE1350

(Counterweight: 48.0 t, without Carbody Weight, without main hook)

Jib Offset Angle: 10°

Unit: Metric tons

Working radius	Boom length	24.4 m				33.5 m				39.6 m			
	Jib length	12.2 m	18.3 m	24.4 m	30.5 m	12.2 m	18.3 m	24.4 m	30.5 m	12.2 m	18.3 m	24.4 m	30.5 m
9.0 m	9.0 m	9.9/26.8											
10.0 m	10.0 m	26.8				11.5/26.8							
12.0 m	12.0 m	26.7	19.2			26.8	13.5/19.2			12.5/26.8			
14.0 m	14.0 m	25.8	18.9	14.3/9.9		26.8	19.1	15.9/9.9		26.8	14.6/19.2		
16.0 m	16.0 m	24.9	18.3	9.7	16.4/5.9	26.0	18.8	9.9	6.0	26.5	19.0	17.0/9.9	
18.0 m	18.0 m	23.9	17.7	9.5	5.8	23.4	18.4	9.7	5.9	23.1	18.7	9.8	19.1/5.9
20.0 m	20.0 m	20.8	16.8	9.2	5.6	20.3	17.9	9.5	5.7	20.0	18.3	9.6	5.8
22.0 m	22.0 m	18.4	15.2	8.8	5.3	17.9	17.4	9.3	5.6	17.5	17.8	9.5	5.7
24.0 m	24.0 m	16.4	13.9	8.4	5.0	15.9	16.1	9.0	5.4	15.5	15.8	9.3	5.6
26.0 m	26.0 m	14.8	12.8	8.0	4.8	14.2	14.5	8.6	5.1	13.9	14.1	9.0	5.4
28.0 m	28.0 m	13.4	11.9	7.7	4.5	12.9	13.1	8.3	4.9	12.5	12.7	8.7	5.1
30.0 m	30.0 m	12.2	11.1	7.4	4.3	11.7	11.9	8.0	4.7	11.3	11.5	8.4	4.9
32.0 m	32.0 m	11.2	10.4	7.2	4.2	10.7	10.9	7.7	4.5	10.3	10.5	8.1	4.7
34.0 m	34.0 m	10.3	9.7	6.9	4.0	9.8	10.0	7.5	4.3	9.4	9.6	7.8	4.6
36.0 m	36.0 m		9.2	6.7	3.8	9.0	9.2	7.3	4.2	8.6	8.8	7.6	4.4
38.0 m	38.0 m		8.7	6.5	3.7	8.3	8.5	7.1	4.0	7.9	8.1	7.4	4.2
40.0 m	40.0 m		8.3	6.3	3.5	7.7	7.9	6.9	3.9	7.3	7.5	7.2	4.1
42.0 m	42.0 m			6.2	3.4	7.2	7.3	6.7	3.8	6.8	7.0	7.0	4.0
44.0 m	44.0 m			6.1	3.3		6.8	6.5	3.6	6.3	6.5	6.7	3.8
46.0 m	46.0 m			6.0	3.2		6.4	6.4	3.5	5.8	6.0	6.2	3.7
48.0 m	48.0 m				3.1		6.0	6.2	3.4		5.6	5.8	3.6
50.0 m	50.0 m				3.0			5.8	3.3		5.2	5.4	3.5
52.0 m	52.0 m							5.4	3.2		4.9	5.1	3.4
54.0 m	54.0 m							5.1	3.2			4.8	3.3
56.0 m	56.0 m								3.1			4.5	3.3
58.0 m	58.0 m								3.0			4.2	3.2
60.0 m	60.0 m												3.1
62.0 m	62.0 m												3.1
64.0 m	64.0 m												3.0

Working radius	Boom length	45.7 m				51.8 m				61.0 m			
	Jib length	12.2 m	18.3 m	24.4 m	30.5 m	12.2 m	18.3 m	24.4 m	30.5 m	12.2 m	18.3 m	24.4 m	30.5 m
12.0 m	12.0 m	13.6/26.8											
14.0 m	14.0 m	26.8	15.7/19.1			14.6/26.8							
16.0 m	16.0 m	26.8	19.1			26.6	16.7/19.1			16.2/21.2			
18.0 m	18.0 m	22.8	18.9	9.9		22.5	19.0	19.1/9.9		20.7	18.3/19.1		
20.0 m	20.0 m	19.6	18.6	9.7	20.1/5.9	19.4	18.8	9.8	21.2/5.9	18.9	18.9	20.7/9.9	
22.0 m	22.0 m	17.2	17.5	9.6	5.8	16.9	17.2	9.6	5.8	16.4	16.8	9.8	22.8/5.9
24.0 m	24.0 m	15.2	15.5	9.4	5.7	14.9	15.2	9.5	5.7	14.4	14.7	9.6	5.8
26.0 m	26.0 m	13.5	13.8	9.3	5.5	13.2	13.5	9.4	5.6	12.7	13.0	9.5	5.7
28.0 m	28.0 m	12.1	12.4	9.0	5.3	11.8	12.1	9.2	5.5	11.3	11.6	9.4	5.6
30.0 m	30.0 m	10.9	11.2	8.7	5.1	10.6	10.9	8.9	5.3	10.1	10.4	9.3	5.5
32.0 m	32.0 m	9.9	10.2	8.4	4.9	9.6	9.9	8.7	5.1	9.1	9.4	9.1	5.3
34.0 m	34.0 m	9.0	9.3	8.1	4.7	8.7	9.0	8.4	4.9	8.2	8.5	8.8	5.2
36.0 m	36.0 m	8.2	8.5	7.9	4.6	7.9	8.2	8.2	4.8	7.4	7.7	8.0	5.0
38.0 m	38.0 m	7.6	7.8	7.7	4.4	7.2	7.5	7.8	4.6	6.7	7.0	7.3	4.9
40.0 m	40.0 m	6.9	7.1	7.4	4.3	6.6	6.8	7.1	4.5	6.1	6.3	6.7	4.7
42.0 m	42.0 m	6.4	6.6	6.9	4.2	6.1	6.3	6.6	4.3	5.5	5.8	6.1	4.6
44.0 m	44.0 m	5.9	6.1	6.3	4.0	5.6	5.8	6.1	4.2	5.0	5.3	5.6	4.4
46.0 m	46.0 m	5.4	5.6	5.9	3.9	5.1	5.3	5.6	4.1	4.6	4.8	5.1	4.3
48.0 m	48.0 m	5.0	5.2	5.5	3.8	4.7	4.9	5.2	4.0	4.1	4.4	4.7	4.2
50.0 m	50.0 m	4.7	4.8	5.1	3.7	4.3	4.5	4.8	3.9	3.7	3.9	4.3	4.1
52.0 m	52.0 m	4.3	4.5	4.7	3.6	4.0	4.2	4.4	3.8	3.3	3.5	3.9	4.0
54.0 m	54.0 m		4.2	4.4	3.5	3.7	3.9	4.1	3.7	2.9	3.1	3.5	3.7
56.0 m	56.0 m		3.9	4.1	3.4	3.3	3.5	3.8	3.6	2.5	2.8	3.2	3.3
58.0 m	58.0 m		3.6	3.8	3.3	3.0	3.2	3.5	3.5	2.2	2.5	2.8	3.0
60.0 m	60.0 m			3.6	3.3		2.9	3.2	3.3		2.2	2.5	2.6
62.0 m	62.0 m			3.3	3.2		2.6	2.9	3.0			2.2	2.4
64.0 m	64.0 m			3.1	3.1		2.4	2.7	2.8			2.0	2.1
66.0 m	66.0 m				2.9			2.4	2.5				
68.0 m	68.0 m				2.7			2.2	2.3				
70.0 m	70.0 m				2.5				2.1				

Note: 1. Rating according to DIN 15018/3 and prEN 13000.
 2. Rating shown in [] are determined by the strength of the boom or other structural components.
 3. The own weight of all load carrying devices of main boom tackle must be subtracted from the capacity of the offset jib at radius.

FIXED JIB LIFTING CAPACITY

(Counterweight: 53.0 t, Carbody Weight: 10.0 t, without main hook)

Jib Offset Angle: 30°

Unit: Metric tons

Working radius	Boom length	24.4 m				33.5 m				39.6 m			
	Jib length	12.2 m	18.3 m	24.4 m	30.5 m	12.2 m	18.3 m	24.4 m	30.5 m	12.2 m	18.3 m	24.4 m	30.5 m
10.0 m													
12.0 m	13.5/18.2												
14.0 m	17.8					15.1/18.2							
16.0 m	16.4	17.5/12.4				17.7				16.2/18.3			
18.0 m	15.2	12.1				16.5	19.0/12.5			17.2			
20.0 m	14.3	11.2	21.4/7.4			15.6	12.1			16.3	20.1/12.5		
22.0 m	13.4	10.5	7.4			14.7	11.3	23.0/7.5		15.5	11.8		
24.0 m	12.7	9.8	7.2	25.3/4.1		14.0	10.7	7.4		14.7	11.2	7.5	
26.0 m	12.1	9.2	7.0	4.0		13.4	10.1	7.2	26.9/4.1	14.1	10.6	7.3	27.9/4.0
28.0 m	11.6	8.8	6.8	3.8		12.8	9.6	7.0	4.0	13.5	10.1	7.1	4.0
30.0 m	11.1	8.3	6.5	3.7		12.3	9.2	6.8	3.8	13.0	9.7	7.0	3.9
32.0 m	10.8	7.9	6.2	3.6		11.9	8.8	6.7	3.7	12.2	9.3	6.8	3.8
34.0 m	10.5	7.6	5.9	3.5		11.5	8.4	6.4	3.6	11.1	8.9	6.7	3.7
36.0 m		7.3	5.6	3.4		10.6	8.1	6.1	3.5	10.2	8.6	6.4	3.6
38.0 m		7.1	5.4	3.3		9.8	7.8	5.9	3.4	9.4	8.3	6.2	3.5
40.0 m		7.0	5.2	3.2		9.1	7.6	5.7	3.3	8.7	8.0	6.0	3.4
42.0 m			5.0	3.1		8.2	7.4	5.5	3.3	8.1	7.8	5.8	3.4
44.0 m			4.9	3.1			7.2	5.3	3.2	7.5	7.6	5.6	3.3
46.0 m			4.8	3.0			7.0	5.2	3.1	6.8	7.4	5.4	3.2
48.0 m				3.0			6.9	5.0	3.1	6.0	6.9	5.3	3.2
50.0 m				2.9				4.9	3.0		6.4	5.1	3.1
52.0 m				2.9				4.8	3.0		5.9	5.0	3.1
54.0 m								4.7	2.9		5.1	4.9	3.0
56.0 m									2.9			4.8	3.0
58.0 m									2.9			4.8	2.9
60.0 m									2.9			4.3	2.9
62.0 m													2.9
64.0 m													2.9
66.0 m													2.9

Working radius	Boom length	45.7 m				51.8 m				61.0 m			
	Jib length	12.2 m	18.3 m	24.4 m	30.5 m	12.2 m	18.3 m	24.4 m	30.5 m	12.2 m	18.3 m	24.4 m	30.5 m
14.0 m													
16.0 m	17.2/18.2												
18.0 m	17.8					18.3/18.2				19.9/18.1			
20.0 m	16.9	21.2/12.5				17.4				18.1			
22.0 m	16.1	12.2				16.7	22.2/12.5			17.3	23.8/12.4		
24.0 m	15.4	11.6	25.1/7.5			15.9	11.9			16.7	12.4		
26.0 m	14.7	11.0	7.4			15.3	11.4	26.1/7.5		15.3	11.9	27.7/7.5	
28.0 m	14.2	10.5	7.3	29.0/4.1		14.2	10.9	7.3		13.8	11.4	7.5	
30.0 m	13.0	10.1	7.1	4.0		12.8	10.5	7.2	30.1/4.0	12.4	11.0	7.3	31.6/4.0
32.0 m	11.9	9.7	7.0	3.9		11.6	10.1	7.1	3.9	11.2	10.6	7.2	4.0
34.0 m	10.8	9.3	6.8	3.8		10.6	9.7	6.9	3.8	10.1	10.2	7.1	3.9
36.0 m	9.9	9.0	6.7	3.7		9.7	9.4	6.8	3.7	9.2	9.8	6.9	3.8
38.0 m	9.1	8.7	6.5	3.6		8.9	9.1	6.7	3.7	8.4	9.0	6.8	3.7
40.0 m	8.4	8.4	6.3	3.5		8.1	8.6	6.5	3.6	7.7	8.2	6.7	3.7
42.0 m	7.8	8.2	6.1	3.4		7.5	8.0	6.3	3.5	7.0	7.6	6.6	3.6
44.0 m	7.2	7.6	5.9	3.4		6.9	7.4	6.1	3.4	6.4	7.0	6.4	3.5
46.0 m	6.7	7.1	5.7	3.3		6.4	6.8	5.9	3.4	5.9	6.4	6.2	3.5
48.0 m	6.2	6.6	5.5	3.2		5.9	6.3	5.8	3.3	5.4	5.9	6.1	3.4
50.0 m	5.5	6.1	5.4	3.2		5.5	5.9	5.6	3.2	4.9	5.4	5.8	3.3
52.0 m	4.8	5.7	5.3	3.1		4.9	5.4	5.5	3.2	4.4	5.0	5.3	3.3
54.0 m		5.3	5.1	3.1		4.4	5.1	5.3	3.1	3.9	4.6	4.9	3.2
56.0 m		4.8	5.0	3.0		3.8	4.7	5.0	3.1	3.5	4.2	4.6	3.2
58.0 m		4.2	4.9	3.0		3.3	4.2	4.6	3.1	3.1	3.8	4.2	3.1
60.0 m			4.5	3.0			3.8	4.3	3.0	2.7	3.4	3.8	3.1
62.0 m			4.0	2.9			3.3	3.9	3.0		3.0	3.4	3.1
64.0 m			3.5	2.9			2.8	3.5	2.9		2.6	3.1	3.0
66.0 m			3.0	2.9				3.1	2.9			2.7	3.0
68.0 m				2.9				2.7	2.9			2.4	2.7
70.0 m				2.9				2.3	2.9				2.4

Note: 1. Rating according to DIN 15018/3 and prEN 13000.

2. Rating shown in [] are determined by the strength of the boom or other structural components.

3. The own weight of all load carrying devices of main boom tackle must be subtracted from the capacity of the offset jib at radius.

FIXED JIB LIFTING CAPACITY

(Counterweight: 48.0 t, without Carbody Weight, without main hook)

Jib Offset Angle: 30°

Unit: Metric tons

Boom length	24.4 m				33.5 m				39.6 m			
Jib length	12.2 m	18.3 m	24.4 m	30.5 m	12.2 m	18.3 m	24.4 m	30.5 m	12.2 m	18.3 m	24.4 m	30.5 m
10.0 m												
12.0 m	13.5/18.2											
14.0 m	17.8				15.1/18.2							
16.0 m	16.4	17.5/12.4			17.7				16.2/18.3			
18.0 m	15.2	12.1			16.5	19.0/12.5			17.2			
20.0 m	14.3	11.2	21.4/7.4		15.6	12.1			16.3	20.1/12.5		
22.0 m	13.4	10.5	7.4		14.7	11.3	23.0/7.5		15.5	11.8		
24.0 m	12.7	9.8	7.2	25.3/4.1	14.0	10.7	7.4		14.7	11.2	7.5	
26.0 m	12.1	9.2	7.0	4.0	13.4	10.1	7.2	26.9/4.1	14.1	10.6	7.3	27.9/4.0
28.0 m	11.6	8.8	6.8	3.8	12.8	9.6	7.0	4.0	12.9	10.1	7.1	4.0
30.0 m	11.1	8.3	6.5	3.7	11.9	9.2	6.8	3.8	11.6	9.7	7.0	3.9
32.0 m	10.8	7.9	6.2	3.6	10.9	8.8	6.7	3.7	10.6	9.3	6.8	3.8
34.0 m	10.4	7.6	5.9	3.5	10.0	8.4	6.4	3.6	9.7	8.9	6.7	3.7
36.0 m		7.3	5.6	3.4	9.2	8.1	6.1	3.5	8.8	8.6	6.4	3.6
38.0 m		7.1	5.4	3.3	8.4	7.8	5.9	3.4	8.1	8.3	6.2	3.5
40.0 m		7.0	5.2	3.2	7.8	7.6	5.7	3.3	7.5	7.9	6.0	3.4
42.0 m			5.0	3.1	7.2	7.4	5.5	3.3	6.9	7.3	5.8	3.4
44.0 m			4.9	3.1		7.1	5.3	3.2	6.4	6.8	5.6	3.3
46.0 m			4.8	3.0		6.6	5.2	3.1	5.9	6.3	5.4	3.2
48.0 m				3.0		6.1	5.0	3.1	5.5	5.8	5.3	3.2
50.0 m				2.9			4.9	3.0		5.4	5.1	3.1
52.0 m				2.9			4.8	3.0		5.0	5.0	3.1
54.0 m							4.7	2.9		4.7	4.9	3.0
56.0 m								2.9			4.6	3.0
58.0 m								2.9			4.3	2.9
60.0 m								2.9			4.0	2.9
62.0 m												2.9
64.0 m												2.9
66.0 m												2.9

Boom length	45.7 m				51.8 m				61.0 m			
Jib length	12.2 m	18.3 m	24.4 m	30.5 m	12.2 m	18.3 m	24.4 m	30.5 m	12.2 m	18.3 m	24.4 m	30.5 m
12.0 m												
14.0 m												
16.0 m	17.2/18.2											
18.0 m	17.8				18.3/18.2				19.9/18.1			
20.0 m	16.9	21.2/12.5			17.4				18.1			
22.0 m	16.1	12.2			16.7	22.2/12.5			17.2	23.8/12.4		
24.0 m	15.4	11.6	25.1/7.5		15.5	11.9			15.1	12.4		
26.0 m	14.0	11.0	7.4		13.8	11.4	26.1/7.5		13.4	11.9	27.7/7.5	
28.0 m	12.6	10.5	7.3	29.0/4.1	12.3	10.9	7.3		11.9	11.4	7.5	
30.0 m	11.3	10.1	7.1	4.0	11.1	10.5	7.2	30.1/4.0	10.7	11.0	7.3	31.6/4.0
32.0 m	10.3	9.7	7.0	3.9	10.0	10.1	7.1	3.9	9.6	10.2	7.2	4.0
34.0 m	9.3	9.3	6.8	3.8	9.1	9.6	6.9	3.8	8.6	9.3	7.1	3.9
36.0 m	8.5	9.0	6.7	3.7	8.3	8.8	6.8	3.7	7.8	8.4	6.9	3.8
38.0 m	7.8	8.3	6.5	3.6	7.5	8.0	6.7	3.7	7.1	7.7	6.8	3.7
40.0 m	7.2	7.6	6.3	3.5	6.9	7.4	6.5	3.6	6.4	7.0	6.7	3.7
42.0 m	6.6	7.0	6.1	3.4	6.3	6.8	6.3	3.5	5.8	6.4	6.6	3.6
44.0 m	6.1	6.5	5.9	3.4	5.8	6.2	6.1	3.4	5.3	5.8	6.2	3.5
46.0 m	5.6	6.0	5.7	3.3	5.3	5.7	5.9	3.4	4.8	5.3	5.7	3.5
48.0 m	5.2	5.5	5.5	3.2	4.9	5.3	5.6	3.3	4.4	4.9	5.2	3.4
50.0 m	4.8	5.1	5.4	3.2	4.5	4.9	5.2	3.2	4.0	4.5	4.8	3.3
52.0 m	4.4	4.7	5.0	3.1	4.1	4.5	4.8	3.2	3.5	4.1	4.4	3.3
54.0 m		4.4	4.6	3.1	3.8	4.2	4.4	3.1	3.1	3.7	4.0	3.2
56.0 m		4.1	4.3	3.0	3.4	3.8	4.1	3.1	2.7	3.3	3.7	3.2
58.0 m		3.8	4.0	3.0	3.1	3.5	3.8	3.1	2.4	2.9	3.3	3.1
60.0 m			3.7	3.0		3.2	3.5	3.0	2.1	2.6	3.0	3.1
62.0 m			3.5	2.9		2.9	3.2	3.0		2.3	2.6	2.9
64.0 m			3.2	2.9		2.6	2.9	2.9		2.0	2.3	2.6
66.0 m			2.9	2.9			2.6	2.9			2.0	2.3
68.0 m				2.9			2.3	2.6				2.0
70.0 m				2.7			2.1	2.3				

Note: 1. Rating according to DIN 15018/3 and prEN 13000.
 2. Rating shown in [] are determined by the strength of the boom or other structural components.
 3. The own weight of all load carrying devices of main boom tackle must be subtracted from the capacity of the offset jib at radius.

SPECIFICATIONS OF PARTS AND ATTACHMENTS

Dimensions: mm Weight: kg

Base Machine

Weight: 63,900kg

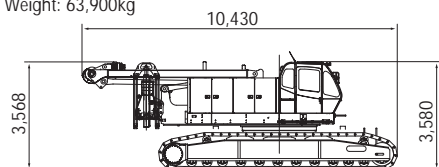

Base Machine (Upper & Carbody)

Weight: 39,700kg

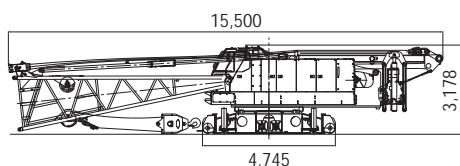

Crawler

Weight: 14,500kg

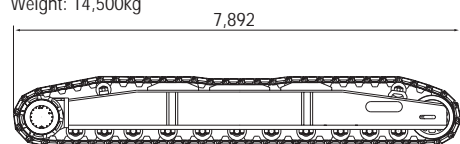

Translifter

Weight: 370kg

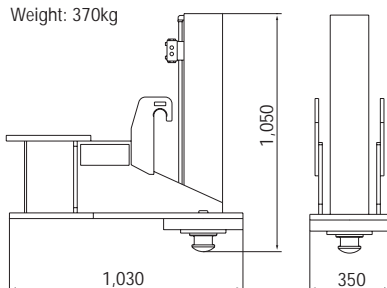

Counterweight (1)

Weight: 8,000kg

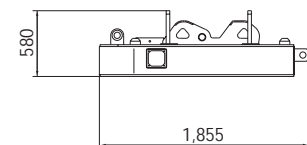
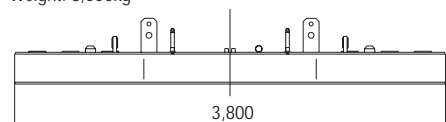

Counterweight (2)

Weight: 5,000kg

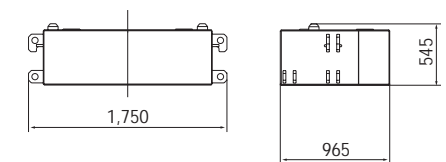

Counterweight (3)

Weight: 2,500kg

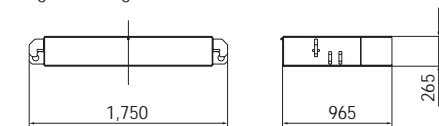

Carbodyweight

Weight: 5,000kg

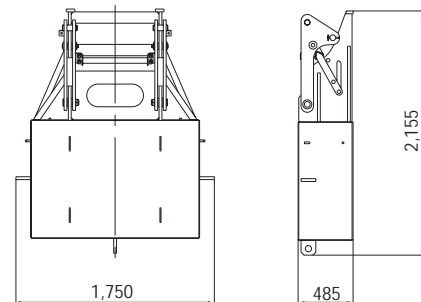

Boom Tip

Weight: 1,660kg

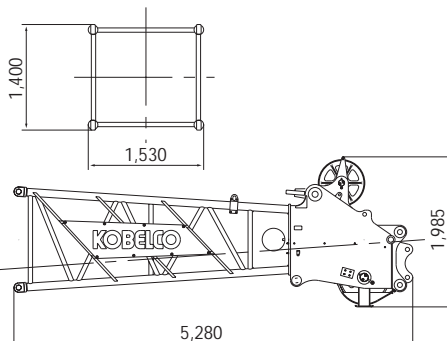

Taper Insert Boom

Weight: 490kg

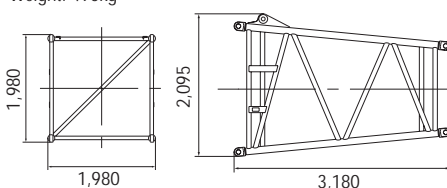

Boom Base

Weight: 2,750kg

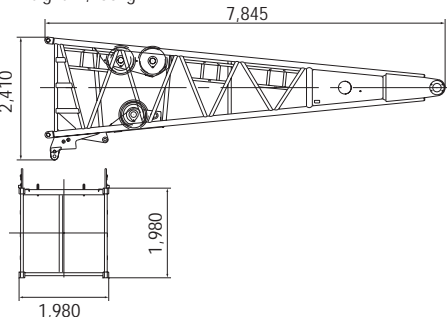

3.0m Insert Boom (with Roller)

Weight: 530kg

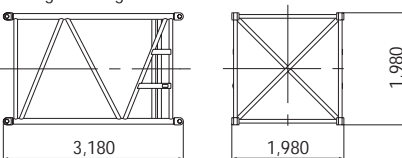

6.1m Insert Boom (with Roller)

Weight: 850kg

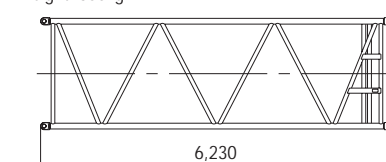

9.1m Insert Boom (with Roller)

Weight: 1,160kg

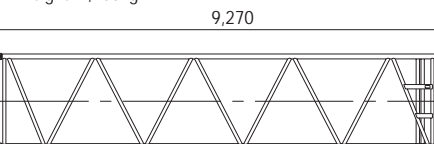

Jib Base with Strut (For Crane)

Weight: 510 kg Width: 1,040 mm

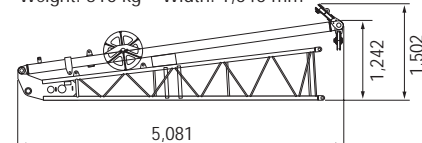

Jib Top (For Crane)

Weight: 315 kg

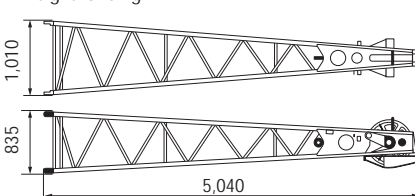

Gantry

Weight: 2,200kg

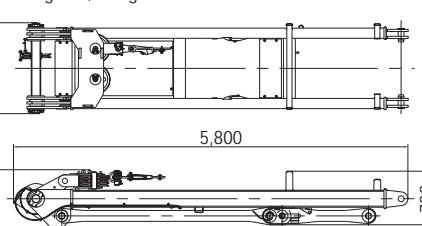

OTHER ATTACHMENTS

Attachment	Weight	Dimensions (L x W x H)
3.0 m Insert Jib	110 kg	3,130 x 840 x 1,020 mm
6.1 m Insert Jib	190 kg	6,175 x 840 x 1,020 mm
Upper Spreader	485 kg	2,045 x 365 x 880 mm
Lower Spreader	315 kg	1,150 x 300 x 930 mm
Self Removable	1,680 kg	1,015 x 1,760 x 2,180 mm
Backstop	515 kg	6,880 x 285 mm

Note: Due to our policy of continual product improvements all designs and specifications are subject to change without advance notice.



KOBELCO CRANES CO., LTD.

17-1, Higashi-Gotanda 2-chome, Shinagawa-ku, TOKYO, 141-8626 JAPAN

Tel: ++81 (0) 3-5789-2130 Fax: ++81 (0) 3-5789-3372