

Potain MD 310 C

Data Sheets

FEM 1.001-A3

MD 310 C K12

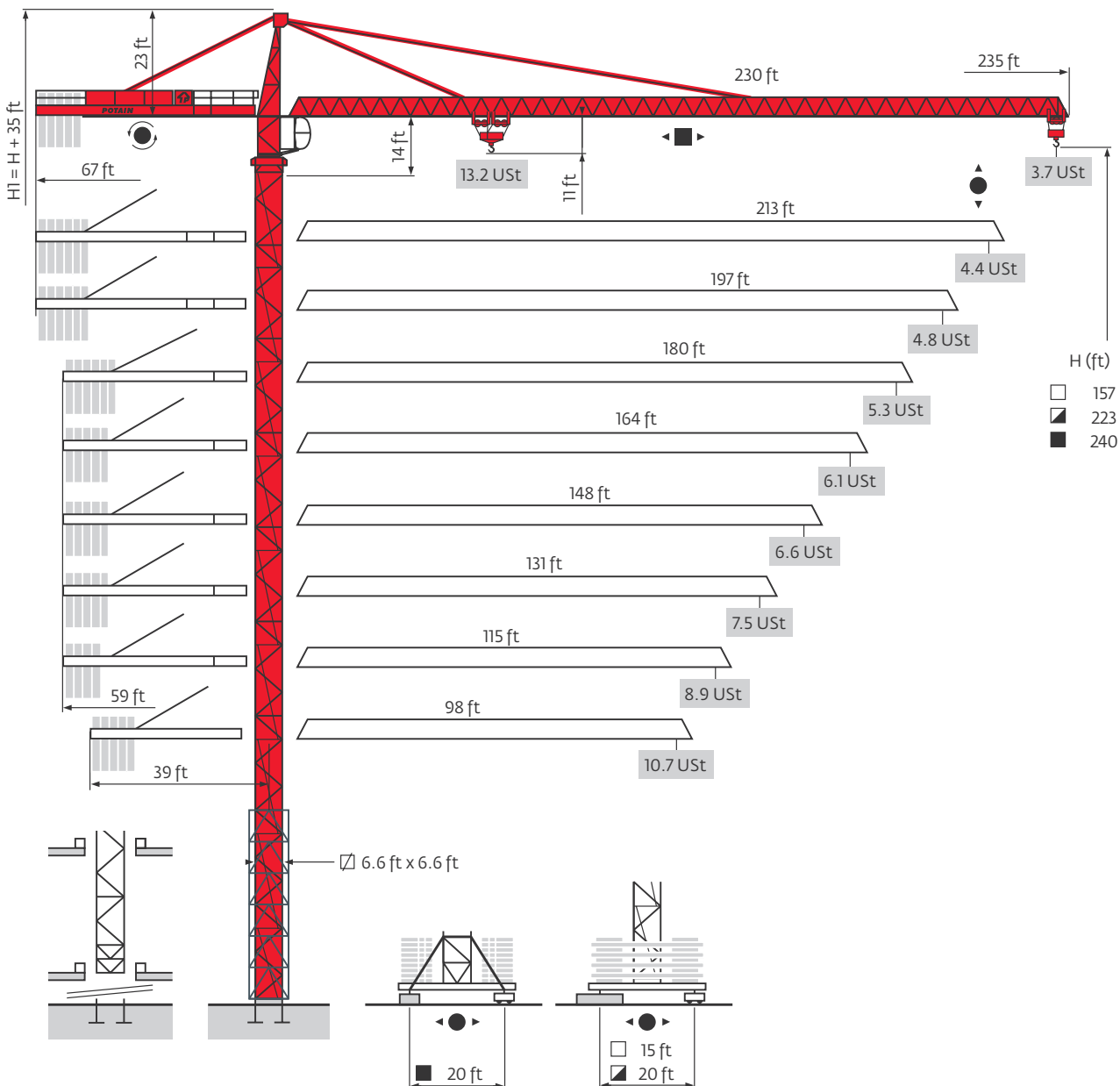

Values have been rounded

Mast

□ 6.6 ft

▧ 98 ft → 230 ft

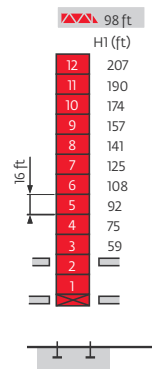
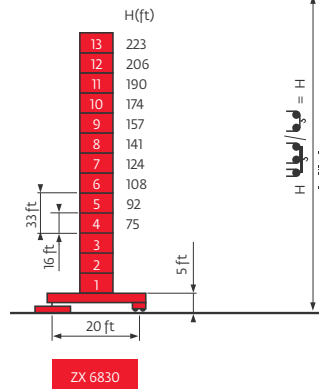
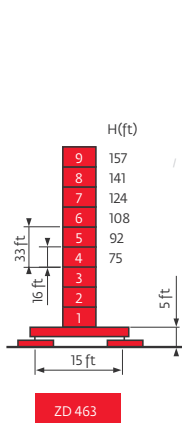
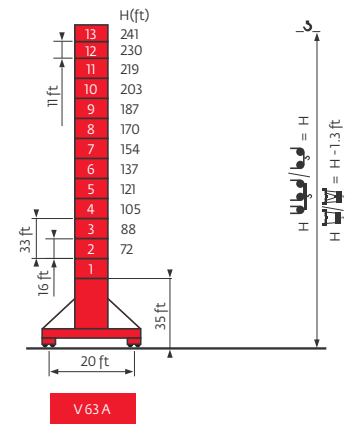
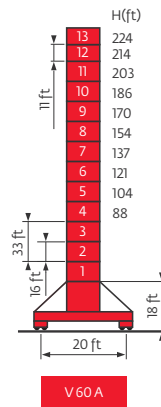
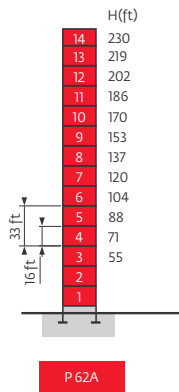
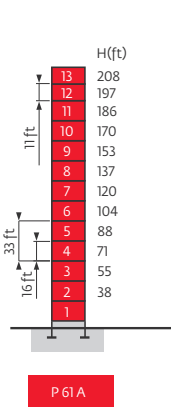

	H1(ft)	16 ft	11 ft
115 ft	207	12	-
131 ft	207	12	-
148 ft	190	11	-
164 ft	169	9	1
180 ft	152	8	1
197 ft	157	9	-
213 ft	147	7	2
230 ft	136	7	1

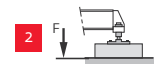

ZD 463 H2 = H

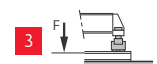

ZX 6830 H3 = H

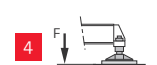

ZD 463 H4 = H - 0.3 ft

ZX 6830 H4 = H - 1 ft

Climbing crane

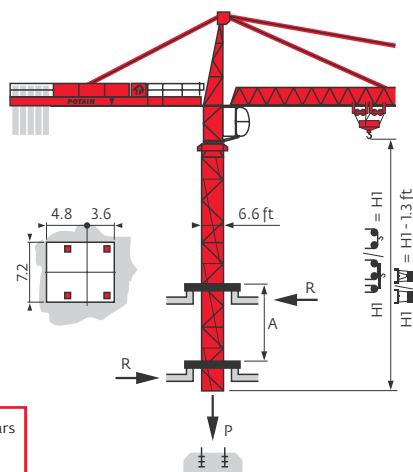

- A** Distance between collars
- H1** Crane height
- P** Crane weight (in service)
- R** Horizontal reaction
- See climbing crane

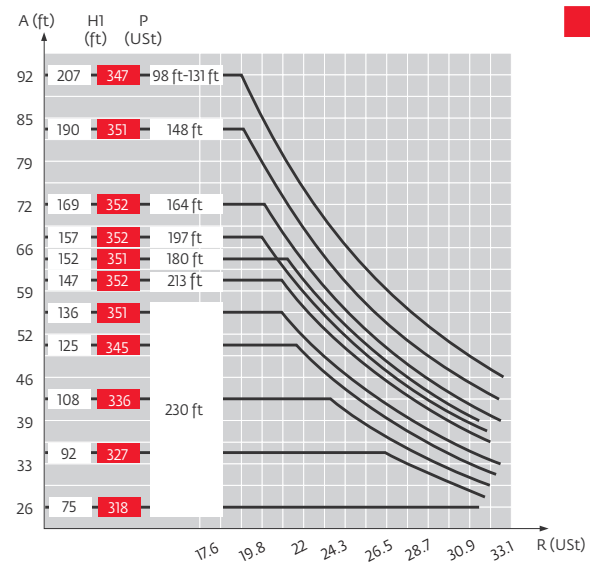

Load charts

230 ft	9	73	82	89	98	105	115	121	131	132	135	138	148	154	164	171	180	187	197	203	213	220	230	ft
	USt	13.2	11.6	10.6	9.4	8.7	7.8	7.3	6.6	6.6	6.6	6.5	6	5.6	5.2	5	4.6	4.4	4.1	4	3.7	3.5	3.4	USt
213 ft	9	75	82	89	98	105	115	121	131	135	139	148	154	164	171	180	187	197	203	213	ft			
	USt	13.2	12	11	9.7	9	8	7.6	6.8	6.6	6.6	6.2	5.8	5.4	5.2	4.7	4.6	4.3	4.1	3.9	USt			
197 ft	9	77	82	89	98	105	115	121	131	138	138	142	148	154	164	171	180	187	197	ft				
	USt	13.2	12.3	11.2	9.9	9.3	8.3	7.7	7.1	6.6	6.6	6.6	6.3	6	5.5	5.3	5	4.7	4.4	USt				
180 ft	9	77	82	89	98	105	115	121	131	138	140	144	148	154	164	171	180	ft						
	USt	13.2	12.3	11.4	10	9.4	8.4	7.8	7.2	6.7	6.6	6.6	6.4	6.1	5.6	5.4	5	USt						
164 ft	9	79	82	89	98	105	115	121	131	138	142	146	148	154	164	ft								
	USt	13.2	12.7	11.6	10.3	9.5	8.6	8	7.3	6.9	6.6	6.6	6.5	6.2	5.8	USt								
148 ft	9	80	82	89	98	105	115	121	131	138	144	148	ft											
	USt	13.2	12.8	11.7	10.4	9.6	8.7	8.2	7.4	6.9	6.6	6.6	USt											
131 ft	9	81	82	89	98	105	115	121	131	ft														
	USt	13.2	13.1	12	10.7	9.9	8.9	8.4	7.6	USt														
115 ft	9	82	89	98	105	115	ft																	
	USt	13.2	12.1	10.7	9.9	9	USt																	
98 ft	9	83	89	98	ft																			
	USt	13.2	12.2	10.8	USt																			

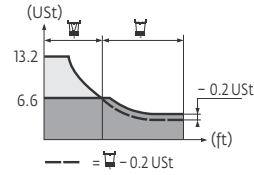

230 ft	10	72	72	82	89	98	105	115	121	128	140	148	154	164	171	180	187	197	203	213	220	230	ft
	USt	13.2	13.2	11.4	10.4	9.1	8.5	7.6	7.1	6.6	6.6	6.3	6	5.5	5.3	5	4.7	4.4	4.3	4.1	3.9	3.7	USt
213 ft	10	76	82	89	98	105	115	121	131	137	149	154	164	171	180	187	197	203	213	ft			
	USt	13.2	12.1	11.1	9.8	9.1	8.2	7.6	6.9	6.6	6.6	6.4	6	5.6	5.3	5.1	4.7	4.6	4.4	USt			
197 ft	10	76	82	89	98	105	115	121	131	137	149	154	164	171	180	187	197	ft					
	USt	13.2	12.1	11.1	9.8	9.1	8.2	7.7	6.9	6.6	6.6	6.4	6	5.6	5.3	5.1	4.8	USt					
180 ft	10	76	82	89	98	105	115	121	131	137	149	154	164	171	180	ft							
	USt	13.2	12.1	11.1	9.8	9.1	8.2	7.7	6.9	6.6	6.6	6.4	6	5.6	5.3	USt							
164 ft	10	78	82	89	98	105	115	121	131	138	140	152	154	164	ft								
	USt	13.2	12.5	11.4	10	9.4	8.4	7.8	7.2	6.7	6.6	6.6	6.5	6.1	USt								
148 ft	10	75	82	89	98	105	115	121	131	136	148	ft											
	USt	13.2	12	11	9.7	9	8.2	7.6	6.9	6.6	6.6	USt											
131 ft	10	81	82	89	98	105	115	121	131	ft													
	USt	13.2	13	11.9	10.6	9.8	8.8	8.3	7.5	USt													
115 ft	10	81	82	89	98	105	115	ft															
	USt	13.2	13.1	12	10.6	9.8	8.9	USt															
98 ft	10	82	89	98	ft																		
	USt	13.2	12.1	10.7	USt																		

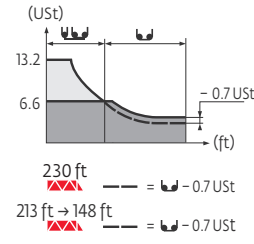







Counter-jib ballast

	10,141 lb - 9259 lb - 5071 lb				9259 lb - 1543 lb			
	50LVF30	75LVF30	100LVF30	150LCC30	75LVF30	100LVF30	150LCC30	
	(lb)							
230 ft	67 ft	56,438	55,556	54,013	51,368	55,556	54,013	50,927
213 ft	67 ft	53,131	52,250	51,368	48,061	52,470	50,927	47,840
197 ft	67 ft	49,824	48,943	48,061	46,297	49,384	47,840	46,297
180 ft	59 ft	57,320	56,438	55,777	52,250	55,556	54,013	52,470
164 ft	59 ft	52,250	51,368	49,824	48,061	50,927	49,384	47,840
148 ft	59 ft	44,754	43,872	42,990	40,786	43,211	41,667	40,124
131 ft	59 ft	38,801	37,920	37,038	33,731	37,038	35,494	33,951
115 ft	59 ft	33,731	32,849	30,424	28,660	30,865	30,865	27,778
98 ft	39 ft	48,061	47,179	46,297	42,990	46,297	44,754	43,211



Base ballast

6.6 ft	V 60 A	H (ft)	224	214	203	186	170	154	137	121	104	88		
		USt	145.5	132.3	105.8	79.4	79.4	79.4	66.1	66.1	66.1	66.1		
6.6 ft	V 63 A	H (ft)	241	230	219	203	187	170	154	137	121	105	88	72
		USt	198.4	172	145.5	119	79.4	79.4	79.4	79.4	66.1	66.1	66.1	66.1
6.6 ft	ZD 463	H (ft)	157	141	124	108	92	75	59	42				
		USt	126.8	126.8	121.3	121.3	115.7	115.7	115.7	115.7				
6.6 ft	ZX 6830	H (ft)	229	206	190	174	157	141	124	108	92	75		
		USt	144.4	111.3	78.3	67.2	67.2	67.2	67.2	67.2	67.2	67.2		

Mechanisms

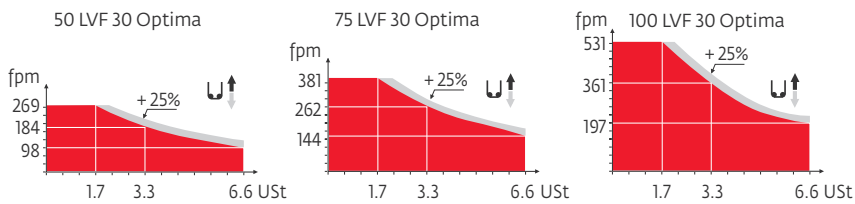
		U ↑						UU ↑						hp	kW		
▲ ▼	50 LVF 30 Optima	fpm	9 - 33 - 98 - 131 - 184 - 269						4 - 16 - 49 - 66 - 92 - 135						50	37	1106 ft
	USt	6.6	6.6	6.6	5	3.3	1.7	13.2	13.2	13.2	9.9	6.6	3.3				
	75 LVF 30 Optima	fpm	12 - 144 - 184 - 262 - 381						6 - 72 - 92 - 131 - 190						75	55	2513 ft
	USt	6.6	5	3.3	1.7	13.2	9.9	6.6	3.3								
100 LVF 30 Optima	fpm	0 - 197 - 262 - 361 - 531						0 - 98 - 131 - 180 - 266						100	75	3087 ft	
USt	6.6	5	3.3	1.7	13.2	9.9	6.6	3.3									
150 LCC 30	fpm	290 - 348 - 433 - 577 - 696						145 - 174 - 217 - 289 - 348						150	110	2497 ft	
USt	6.6	5	3.3	1.7	0.8	13.2	9.9	6.6	3.3	1.7							
◀ ▶	6 DVF 4	fpm	0 - 164 (13.2 USt) 0 - 328 (6.6 USt) 0 - 394 (3.3 USt)						5.5	4							
	RVF162 Optima +	rpm	0 - 0.7						2 x 7.5	2 x 5.5							
V60 A 	RT 544 A1 2V R ≥ 13 m	fpm	52 - 105						4 x 8.4	4 x 6.2							
V63 A 																	
ZX 6830 	RT 664 A2B 2V	fpm	62 - 125						6 x 8.4	6 x 6.2							
CEI 38 		IEC 38		kVA													
480 V (+6% -10%) 60 Hz				50 LVF : 75 kVA 75 LVF : 100 kVA 100 LVF : 125 kVA 150 LCC : 175 kVA													



-  Hoisting
-  Traveling
-  Slewing
-  Traveling

MD 310 C K16

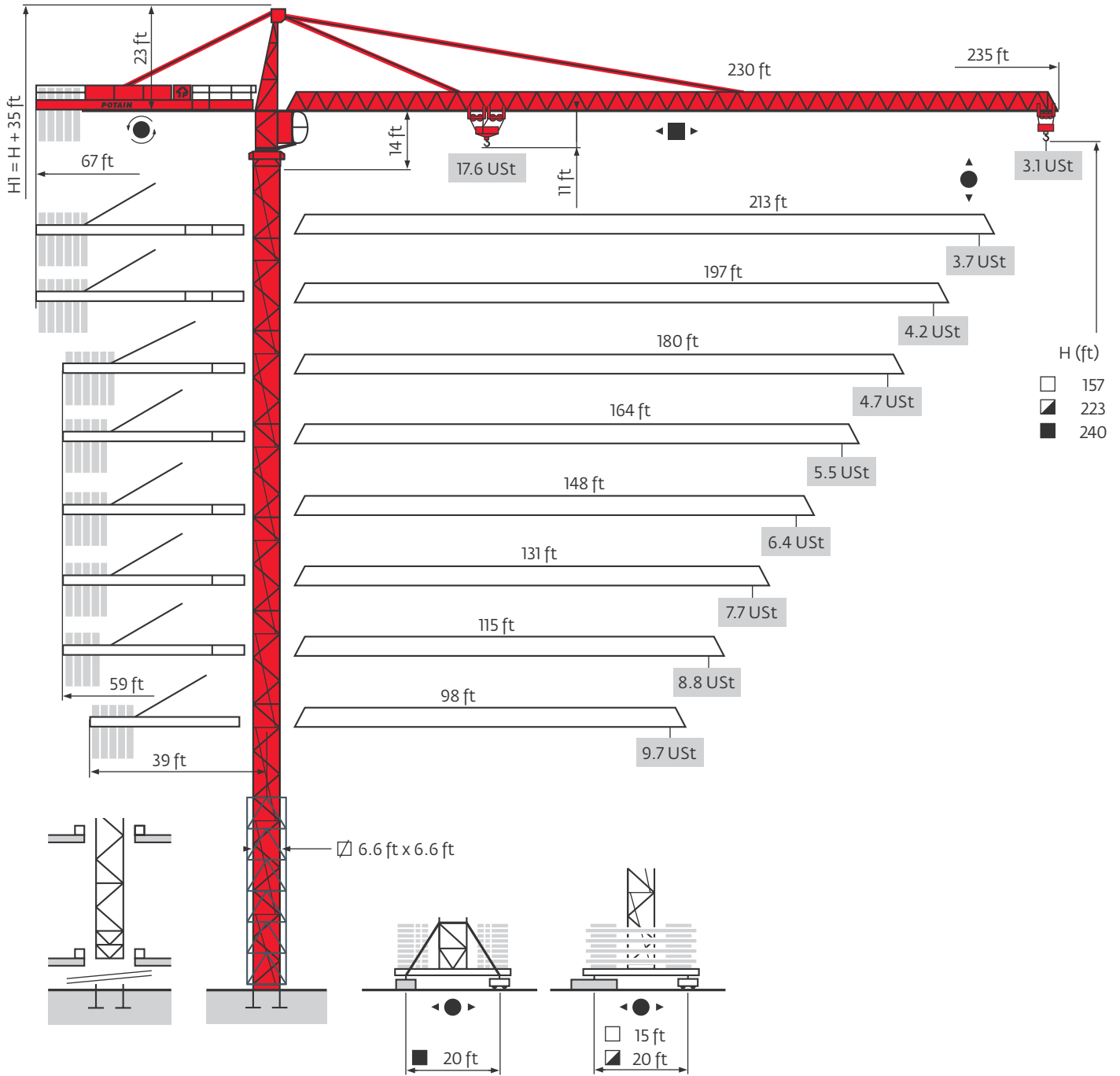

Mast

□ 6.6 ft
 ▴ 98 ft → 230 ft

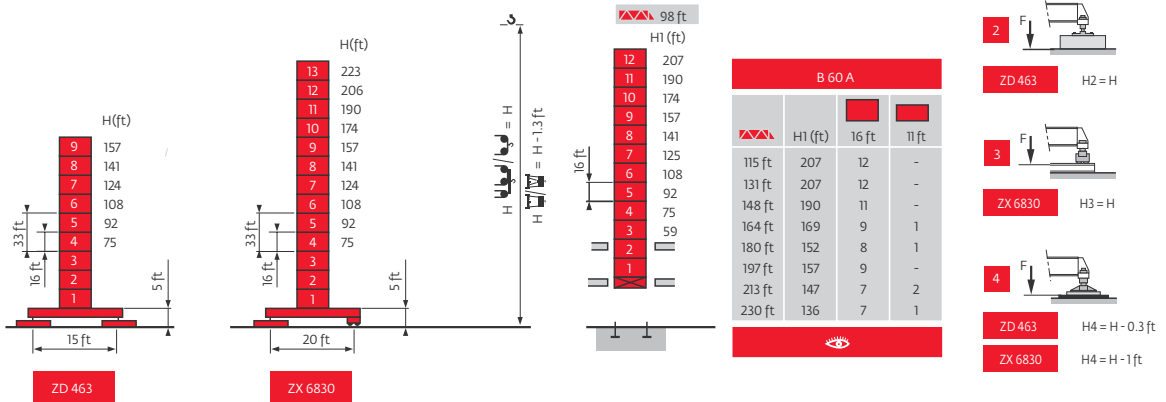
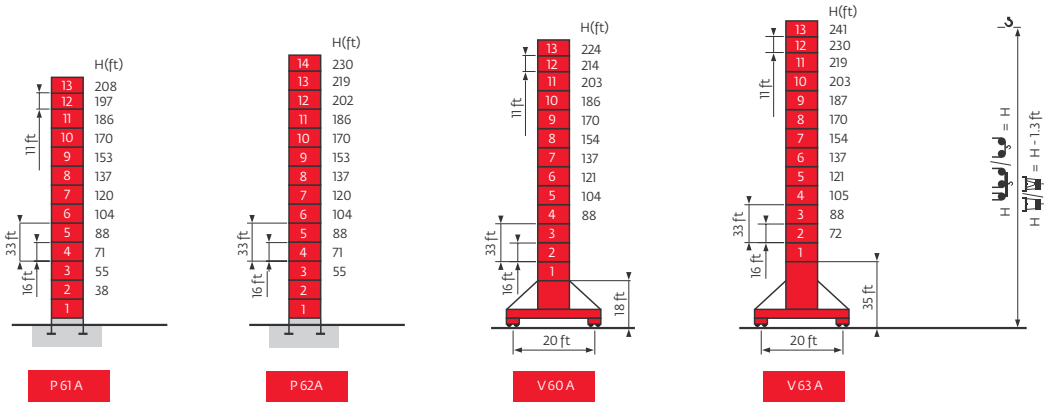

Climbing crane

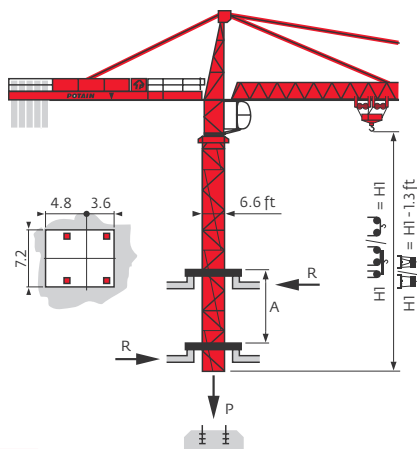

- A** Distance between collars
- H1** Crane height
- P** Crane weight (in service)
- R** Horizontal reaction
- See climbing crane

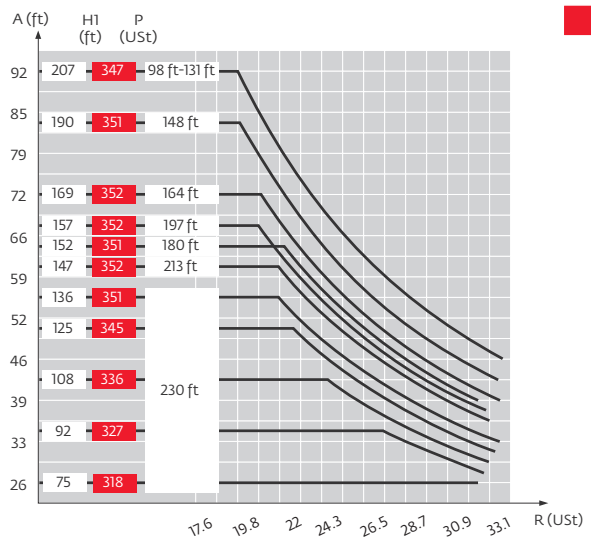

Load charts

230 ft	10	▶		103	105	115	121	131	138	148	154	164	171	180	187	197	203	213	220	230	ft
▲▲▲				8.8	8.7	7.8	7.3	6.6	6.2	5.7	5.4	5	4.7	4.4	4.2	3.9	3.7	3.5	3.3	3.1	USt
213 ft	10	▶		109	115	121	131	138	148	154	164	171	180	187	197	203	213	ft			
▲▲▲				8.8	8.3	7.7	7.1	6.6	6.1	5.7	5.3	5.1	4.7	4.5	4.2	4	3.7	USt			
197 ft	10	▶		109	115	121	131	138	148	154	164	171	180	187	197	ft					
▲▲▲				8.8	8.3	7.7	7.1	6.6	6.1	5.7	5.3	5.1	4.7	4.5	4.2	USt					
180 ft	10	▶		110	115	121	131	138	148	154	164	171	180	ft							
▲▲▲				8.8	8.4	7.8	7.2	6.7	6.2	5.8	5.4	5.2	4.8	USt							
164 ft	10	▶		112	115	121	131	138	148	154	164	ft									
▲▲▲				8.8	8.6	8	7.3	6.9	6.4	6.1	5.6	USt									
148 ft	10	▶		115	115	121	131	138	148	ft											
▲▲▲				8.8	8.8	8.3	7.5	7.1	6.5	USt											
131 ft	10	▶		118	121	131	ft														
▲▲▲				8.8	8.6	7.8	USt														
115 ft	10	▶		115	ft																
▲▲▲				8.8	USt																
98 ft	10	▶		98	ft																
▲▲▲				8.8	USt																

230 ft	10	▶	53	56	66	72	82	89	93	103	105	115	121	131	138	148	154	164	171	180	187	197	203	213	220	230	ft
▲▲▲			17.6	16.9	13.8	12.2	10.5	9.5	8.8	8.8	8.7	7.8	7.3	6.6	6.2	5.7	5.4	5	4.7	4.4	4.2	3.9	3.7	3.5	3.3	3.1	USt
213 ft	10	▶	56	66	72	82	89	98	109	115	121	131	138	148	154	164	171	180	187	197	203	213	ft				
▲▲▲			17.6	14.7	13	11.1	10	8.8	8.8	8.3	7.7	7.1	6.6	6.1	5.7	5.3	5.1	4.7	4.5	4.2	4	3.7	USt				
197 ft	10	▶	56	66	72	82	89	98	109	115	121	131	138	148	154	164	171	180	187	197	ft						
▲▲▲			17.6	14.7	13	11.1	10	8.8	8.8	8.3	7.7	7.1	6.6	6.1	5.7	5.3	5.1	4.7	4.5	4.2	USt						
180 ft	10	▶	56	66	72	82	89	98	109	115	121	131	138	148	154	164	171	180	ft								
▲▲▲			17.6	14.7	13	11.1	10	8.8	8.8	8.3	7.7	7.1	6.6	6.1	5.7	5.3	5.1	4.7	USt								
164 ft	10	▶	57	66	72	82	89	98	100	111	115	121	131	138	148	154	164	ft									
▲▲▲			17.6	15	13.3	11.4	10.4	9	8.8	8.8	8.5	7.9	7.2	6.8	6.3	6	5.5	USt									
148 ft	10	▶	58	66	72	82	89	98	102	113	115	121	131	138	148	ft											
▲▲▲			17.6	15.3	13.7	11.7	10.6	9.3	8.8	8.8	8.7	8.2	7.4	6.9	6.4	USt											
131 ft	10	▶	61	66	72	82	89	98	105	106	117	121	131	ft													
▲▲▲			17.6	16.1	14.3	12.2	11.1	9.7	8.9	8.8	8.8	8.5	7.7	USt													
115 ft	10	▶	59	66	72	82	89	98	104	115	ft																
▲▲▲			17.6	15.7	13.9	11.9	10.8	9.5	8.8	8.8	USt																
98 ft	10	▶	61	66	72	82	89	98	ft																		
▲▲▲			17.6	16.2	14.3	12.2	11.1	9.7	USt																		

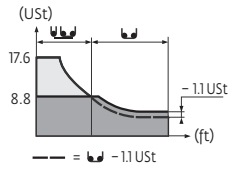







Counter-jib ballast

	10,141 lb - 9259 lb - 5071 lb				9259 lb - 1543 lb				
		75LVF40	100LVF40	150LCC40		75LVF40	100LVF40	150LCC40	
▲▲▲		(lb)							
230 ft	67 ft	56,438	54,013	51,368	67 ft	55,556	54,013	50,927	
213 ft	67 ft	53,131	51,368	48,061	67 ft	52,470	50,927	47,840	
197 ft	67 ft	49,824	48,061	46,297	67 ft	49,384	47,840	46,297	
180 ft	59 ft	57,320	55,777	52,250	59 ft	55,556	54,013	52,470	
164 ft	59 ft	52,250	49,824	48,061	59 ft	50,927	49,384	47,840	
148 ft	59 ft	44,754	42,990	40,565	59 ft	44,754	41,667	40,124	
131 ft	59 ft	38,801	37,038	33,731	59 ft	38,581	35,494	33,951	
115 ft	59 ft	33,731	30,424	28,660	59 ft	32,408	30,865	27,778	
98 ft	39 ft	48,061	46,297	42,990	39 ft	47,840	44,754	43,211	





Base ballast

☑ 6.6 ft	V60 A	●	H (ft)	224	214	203	186	170	154	137	121	104	88		
			▲ (USt)	145.5	132.3	105.8	79.4	79.4	79.4	66.1	66.1	66.1	66.1		
☑ 6.6 ft	V63 A	●	H (ft)	241	230	219	203	187	170	154	137	121	105	88	72
			▲ (USt)	198.4	172	145.5	119	79.4	79.4	79.4	79.4	66.1	66.1	66.1	66.1
☑ 6.6 ft	ZD 463	●	H (ft)	157	141	124	108	92	75	59	42				
			▲ (USt)	126.8	126.8	121.3	121.3	115.7	115.7	115.7	115.7				
☐ 6.6 ft	ZX 6830	●	H (ft)	229	206	190	174	157	141	124	108	92	75		
			▲ (USt)	144.4	111.3	78.3	67.2	67.2	67.2	67.2	67.2	67.2	67.2		

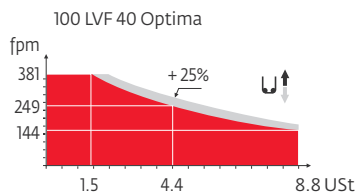
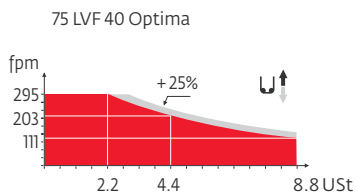
Mechanisms

		U↑					UU↑					hp	kW										
▲ ▼	75 LVF 40 Optima	fpm	0	-	111	-	144	-	203	-	295	0	-	55	-	72	-	102	-	148	75	55	2090 ft
		USt	8.8			6.6	4.4	2.2				17.6		13.2	8.8	4.4							
▲ ▼	100 LVF 40 Optima	fpm	0	-	144	-	184	-	249	-	381	0	-	72	-	92	-	112	-	190	100	75	3727 ft
		USt	8.8			6.6	4.4	1.5				17.6		13.2	8.8	3.1							
▲ ▼	150 LCC 40	fpm	230	-	276	-	348	-	459	-	551	115	-	138	-	174	-	230	-	176	150	110	3583 ft
		USt	8.8	6.6	4.4	2.2	1.1					17.6	13.2	8.8	4.4	2.2							
◀ ▶	6 DVF 6	fpm	0 - 134 (17.6 USt) 0 - 276 (8.8 USt) 0 - 328 (4.4 USt)									5.5	4										
	RVF 162 Optima +	rpm	0 - 0.7									2 x 7.5	2 x 5.5										
V60 A 	RT 544 A1 2V R ≥ 13 m	fpm	52 - 105									4 x 8.4	4 x 6.2										
V63 A 																							
ZX 6830 	RT 664 A2B 2V	fpm	62 - 125									6 x 8.4	6 x 6.2										
CEI 38 			IEC 38			kVA																	
480 V (+6% -10%) 60 Hz						75 LVF : 100 kVA 100 LVF : 125 kVA 150 LCC : 175 kVA																	



-  Hoisting
-  Trolleying
-  Slewing
-  Traveling

Constant improvement and engineering progress make it necessary that we reserve the right to make specification, equipment and price changes without notice. Illustrations shown may include optional equipment and accessories, and may not include all standard equipment.

Regional Headquarters

Americas

Manitowoc, Wisconsin, USA
Tel: +1 920 684 6621
Fax: +1 920 683 6277

Shady Grove, Pennsylvania, USA

Tel: +1 717 597 8121
Fax: +1 717 597 4062

Europe, Middle East, Africa

Ecully, France
Tel: +33 472 18 2020
Fax: +33 472 18 2000

Asia - Pacific

Shanghai, China
Tel: +86 21 6457 0066
Fax: +86 21 6457 4955



www.manitowoc.com

Potain MD 310 C
Code 09-001-1M-109