

# Manitowoc 10000

## Product Guide



### Features

- 90 t (100 USt) capacity
- 314 m-ton (2,270 ft-kips) maximum load moment
- 61 m (200 ft) heavy-lift boom
- 76,2 m (250 ft) fixed jib on heavy-lift boom
- 80,8 m (265 ft) luffing jib on heavy-lift boom



# Contents

Specifications	3
Outline dimensions	6
Crane assembly	11
Winch performance data	12
Load chart notes	13
Boom combinations	14
Heavy-lift boom range / charts	16
Fixed jib boom range / load charts	18
Luffing jib boom range / load charts	21
Clamshell	25
Manitowoc Crane Care	26

# Specifications

## Upperworks



### Engine

Hino P11C-UN, 6 cylinder, water-cooled diesel, direct fuel injection with turbocharger, 247 kW (332 HP) at 2000 high-idle RPM. Maximum torque 1300 N•m (959 lb•ft) net at 1,500 rpm (SAE J 1349).

One diesel fuel tank, 400 liters (105 gallons) capacity.

Two 12 volt 136 AH capacity batteries, 24 volt system and 50 amp alternator.

All wiring harnesses and connectors are numbered for easier servicing. Machine is equipped with individual fused branch circuits.



### Controls

Full-flow hydraulic control system for constant variable pressure to front and rear drums, boom hoist brakes and clutches. Controls respond instantly to the touch, delivering smooth function operation.

#### Relief valve pressures:

##### Load hoist, boom hoist

and propel system . . . . . 315kg/cm<sup>2</sup> (4,480 psi)

Swing system . . . . . 280 kg/cm<sup>2</sup>, (980psi)

Control system . . . . . 80 kg/cm<sup>2</sup> (1,140 psi)



### Hydraulic system

All three variable displacement piston-type pumps are driven by a heavy-duty pump drive. One of these pumps is used in the right propel circuit and hook hoist circuit, and can accommodate an optional third circuit. Another is used in the left propel circuit, boom hoist circuit and hook hoist circuit. The third variable displacement pump is used in the swing circuit. In addition, two gear pumps are used in the control system and auxiliary equipment, and two gear pumps serve the brake cooling system.

**Maximum pressure rating** . . . 325 kg/cm<sup>2</sup> (4,640 psi)

**Load hoist, boom hoist and propel** . . 2 Piston pumps

**Swing** . . . . . 1 Piston pump

**Control system and auxiliary** . . . . . 2 Gear pumps

**Brake cooling system** . . . . . 2 Gear pumps

**Reservoir capacity:** . . . . . 380 liter (100 US gallon).

**Cooling:** Oil-to-air heat exchanger (plate-fin type).

**Filtration:** Full-flow and bypass type with replaceable paper element.



### Drums

Front and rear drums for load hoist powered by hydraulic variable displacement piston-type motors, driven through planetary reducers. Powered hoisting/lowering and free-fall operation is standard. Drum turn indicators for front and rear drums are also standard.

**Brake & Clutches (compatible):** Forced-circulation oil-cooled wet-type multi-disc brakes, each using positive and negative actuation. An external ratchet is fitted for locking the drums.

**Drums:** (front and rear) 613 mm (24.1") P.C.D. x 622 mm (24.5") wide drums, grooved for 26 mm wire rope.

#### Wire rope capacity:

Front drum . . . . . 235 m (771 ft) working length

Rear drum . . . . . 160 m (525 ft) working length

Storage length (each drum) . . . . . 253 m (830')

**Line speed:** Single line on the first drum layer

**Hoisting:** . . . . . 120m/min (394 ft/min)

**Lowering:** . . . . . 120m/min (394 ft/min)

➤ **Optional third drum:** same dimensions and specifications as front and rear drums.

Wire rope working length . . . . . 190m (623').



### Swing system

**Swing unit:** Powered by a hydraulic piston-type motor driving spur gears through planetary reducers, the swing system provides 360° rotation.

**Swing brake:** A spring-set, hydraulically released multiple-disc brake is internally fitted in swing motor.

**Swing lock:** 2-Position lock for transportation.

**Rotating bed turntable:** Single-row ball bearing with an integral internally cut swing gear.

**Swing speed:** 4.0 rpm



### Boom support system

Single drum powered by a hydraulic axial piston motor through a planetary reducer.

**Brake:** A spring-set, hydraulically released multiple-disc brake is internally fitted in the boom hoist motor and operated through a counter-balance valve. An external ratchet is fitted for locking the drum.

**Drum:** Single drum, grooved for 16 mm diameter wire rope. Boom Hoist reeving is 12-part line.

# Specifications

## Wire Rope Capacity:

Drum 150 m (492 ft) working length.

**Line speed:** Single line on the first drum layer

**Hoisting** ..... 70m/min (230 ft/min)

**Lowering** ..... 70m/min (230 ft/min)



## Gantry

This high folding type gantry is fitted with a sheave frame for boom hoist reeving. Hydraulic lift is standard. It provides full up, full down positions with linkage.



## Counterweight

Qty.	Item	Unit Weight		Total Weight	
		kg	lb	kg	lb
2	Carbody Each	3 650	8,050	7 300	16,100
<b>Carbody total</b>				<b>7 300</b>	<b>16,100</b>
1	Upperworks				
	Counterweight A	12 100	26,670	12 100	26,670
1	Counterweight B	7 400	16,320	7 400	16,320
1	Counterweight C	9 300	20,510	9 300	20,510
<b>Upperworks total</b>				<b>28 800</b>	<b>63,500</b>
<b>Counterweight total</b>				<b>36 100</b>	<b>79,600</b>



## Operator's cab

Totally enclosed, full vision cab fitted with tinted safety glass. A fully adjustable, highbacked seat with arm rests permits operators to set their ideal working position. Side mounted console for auxiliary controls and instruments. An air conditioner, a signal horn, cigarette lighter, windshield wiper and inspection lamp socket are standard features.

## Controls

In front of operator are the foot pedals for front, rear and third drum (optional) brakes and foot throttle pedal. At operator's right side are the travel (propel) control levers and the function lock lever. To the operator's right front are the boom hoist control lever, front and rear winch control levers and the free-fall select switches for the front and rear winches and drum turn indicators (front /rear drum). To the operator's left front are the swing control lever and third drum (optional) control lever. To the operator's left are the crawler extend/retract lever and the positive swing lock. The left hand console contains toggle switches for travel (propel) speed, free-fall high/low select, gantry control, crane/clamshell select switch and the anti-two-block/boom overhoist switches. Directly in front of the console are the drum pawl lock for boom, front, rear and third drum (optional) and the engine ignition key. The swing parking brake and signal horn are mounted on the swing control lever.

## Gauges

Fuel gauge, engine water temperature gauge, hour meter and tachometer are located on the monitor display.

## Warning display

All potential warnings, including battery charge, engine oil pressure, air cleaner, engine oil filter, control main pressure, and hydraulic oil temperature will appear on the monitor display when a fault occurs.

## Safety device

Function lock lever, anti-two-block, boom over hoist limit switch, boom angle indicator, signal horn, boom hoist drum lock, front and rear drum lock, swing lock, swing alarm (buzzer and lamps), boom backstops and load moment indicator.

## Lowerworks



## Carbody

The durable carbody features steel welded construction with extendible axles.



## Crawlers

Crawler assemblies can be hydraulically extended for wide-track operation or retracted for transportation. Crawler belt tension adjusted with hydraulic jack and maintained by shims between idler block and frame.

## Crawler drive

The independent hydraulic propel drive is built into each crawler side frame. Each drive consists of a hydraulic motor driving a propel sprocket through a planetary gearbox. The hydraulic motor and gearbox are built into the crawler side frame within the shoe width. The track rollers are sealed for maintenance-free operation.

## Crawler brakes

Spring set, hydraulically released, multiple disc-type parking brakes are built into each propel drive.

## Steering mechanism

The hydraulic propel system provides both skid steering (driving one track only) and counter-rotating steering (driving each track in opposite direction) and differential track speed.

## Crawler shoes

66 shoes per side, 914 mm (36") wide each crawler.

**Travel speed** (High/Low) 1.9/1.2 km/h (1.18/0.75 mph)

# Specifications

## Attachments



### Boom

Welded lattice construction using tubular, high-tensile steel chords with pin connections between sections. Boom tip is open throat construction. Two idler sheaves and three point sheaves are standard.

Basic boom length 12,2 m (40') consists of the boom butt section 5,8 m (19') and boom top section 6,39 m (21').

Optional boom inserts are available to provide extension capabilities. They also have welded lattice construction with tubular, high-tension steel chords and pin connections on each one of 3,0 m (10'), 6,1 m (20'), 12,2 m (40') inserts.

Maximum total length of boom 61,0 m (200').



### Fixed jib

The optional fixed jib employs welded lattice construction with tubular, high-tension steel chords with pin connections between sections.

Basic jib length 9,14 m (30') consists of jib butt section 4,57 m (15') and jib top section 4,57 m (15').

Optional jib boom inserts of 3,0 m (10'), 6,1 m (20') are available for extension capabilities up to 18,3 m (60').

Maximum total length of boom and jib 57,9 m (190') + 18,3 m (60') is 76,2 m (250').



### Luffing jib

➤ Optional: Components to make up 16,7 m (55') basic luffing boom including 6,1 m (20') butt, 9,1 m (30') boom special insert (with idler sheave), 1,5 m (5') top, 5,7 m (19') luffing jib butt, boom strut assembly, jib strut assembly, jib stop assembly, strut backstops, backstay pendants with sheaves, mounting parts and LMI Hardware.

➤ Optional: 3,1 m (10'), 6,1 m (20'), and 9,1 m (30') luffing boom inserts. Utilize optional boom inserts to make up to 35,0 m (115') of luffing boom.

➤ Optional: 15,2 m (50') basic luffing jib assembly including 5,8 m (19') luffing jib butt, 3,0 m (10') luffing jib insert, 6,4 m (21') luffing jib top, 6,4 m (21') front strut assembly, 5,3 (17' 5") rear strut assembly, and luffing jib point roller assembly (single sheave) which is required during erection of the jib.

The 6,4 m (21') luffing jib top utilizes the existing boom top from the base crane.

Maximum 45,7 m (150') jib length for 32,0 m (105') boom length and maximum 30,4 m (100') jib length for 35,0 m (115') boom length.

Note: Luffing jib top and inserts use liftcrane boom top and inserts. Also, the third drum and wire rope must be ordered with luffing jib attachment.

## Tools and accessories

A set of tools and accessories are furnished.

## Optional Equipment

- Optional: Blocks and Hooks each with roller bearing sheaves grooved for 26.0 mm (1.02") dia. wire rope, and roller bearing swivel with hook latch.
- 11 t ball hook, 292 kg, wedge socket for 26 mm wire rope. (12 USt ball hook, 722 lb, wedge socket for 26 mm wire rope.)
- 35 t hook block, 700 kg with one 622 mm Nominal O.D. roller bearing sheave. (50 USt hook block, 2,311 lb with three 24" Nominal O.D. roller bearing sheaves.)
- 70 t hook block, 900 kg, three 622 mm Nominal O.D. roller bearing bearing sheaves. (75 USt hook block, 3,820 lb, with four 24" Nominal O.D. roller bearing sheaves.)
- 90 t hook block, 1 300 kg, with four 622 mm Nominal O.D. roller bearing sheaves. (100 USt hook block, 2,946 lb with four 24" Nominal O.D. roller bearing sheaves.)
- Optional: Detachable upper boom point with one 575 mm Nominal outer diameter roller bearing steel sheave grooved for 26mm rope for liftcrane.

Travel kit  
Custom color

## Working weight

Approximately 81,500 kg (179,700 lb) including upperworks and lowerworks, full upper counterweights, full carbody counterweights and 12,2 m (40') basic boom.

## Ground pressure

Approximately 75.6 kPa (11.0 psi) with basic boom and no load.

## Gradeability

With basic boom: 40%.

# Outline dimensions

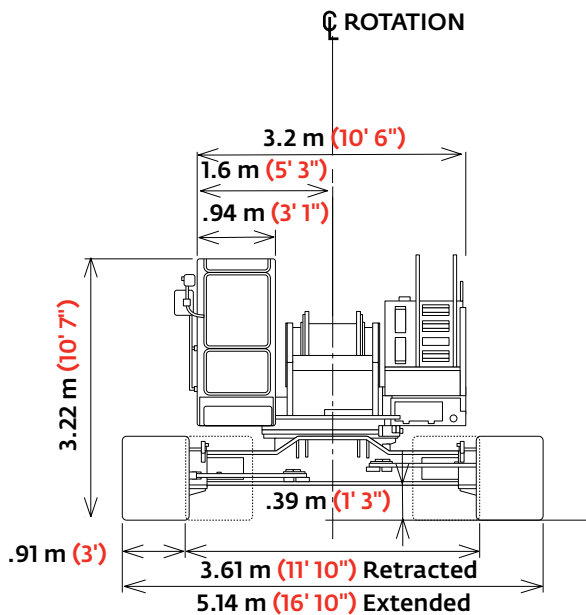
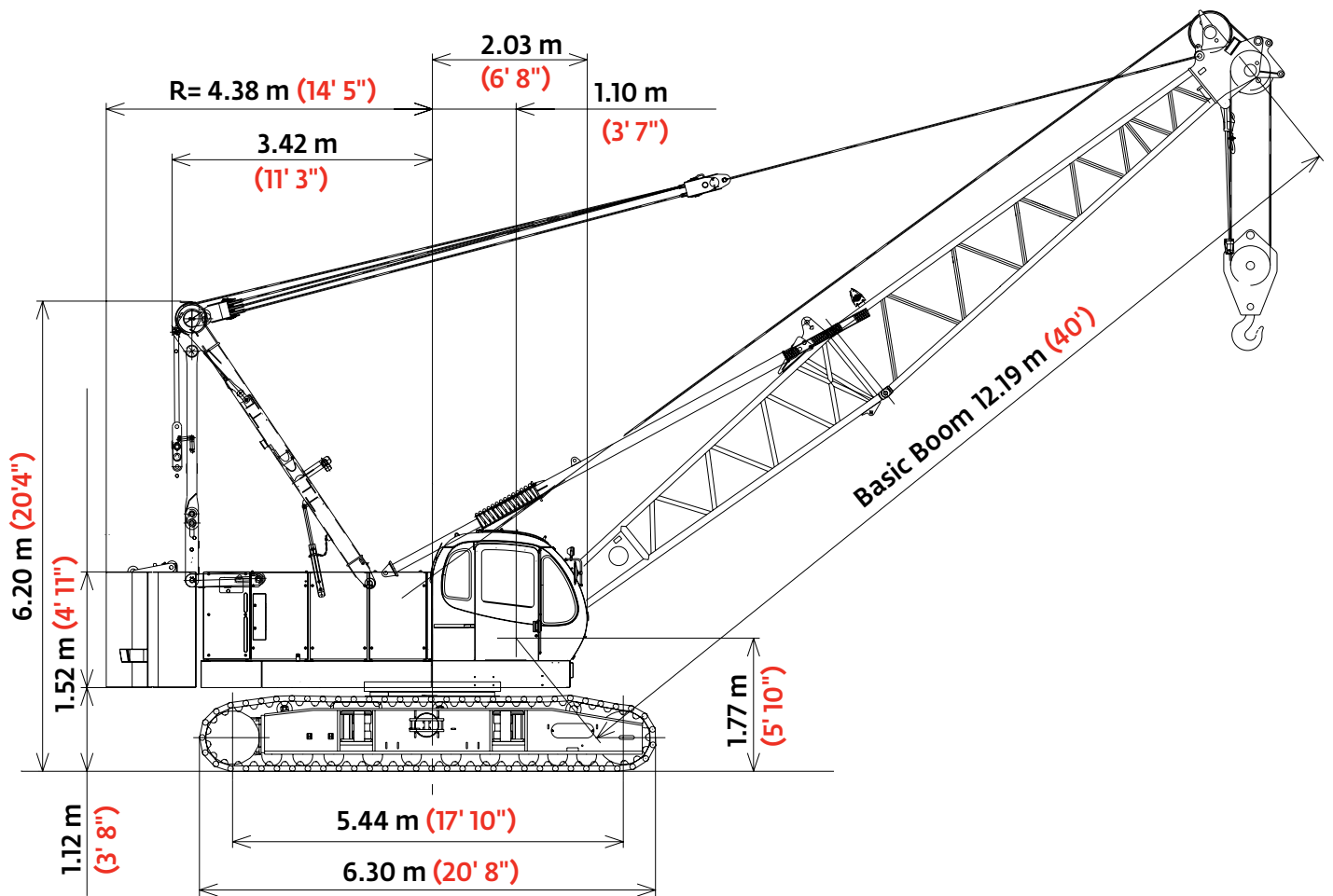

# Outline dimensions

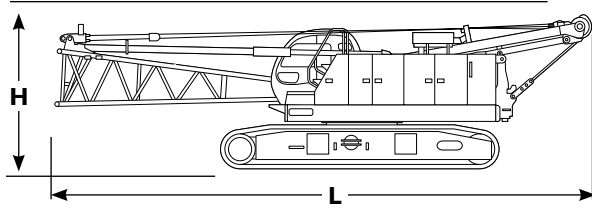

Upperworks		x 1
Length	12,19 m	40' 0"
Width	3,61 m	11' 10"
Height	3,32 m	10' 10"
Weight	45 750 kg	100,860 lb

*Note: Weight includes base machine, crawler, gantry, maximum hoist and whip lines on drums, boom butt, full hydraulic fluid reservoir, and one third tank of fuel.*

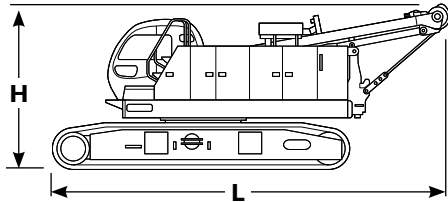

Upperworks		x 1
Length	8,44 m	27' 8"
Width	3,61 m	11' 10"
Height	3,32 m	10' 10"
Weight	43 500 kg	95,900 lb

*Note: Weight includes base machine, crawler, gantry, maximum hoist and whip lines on drums, full hydraulic fluid reservoir, and one third tank of fuel.*

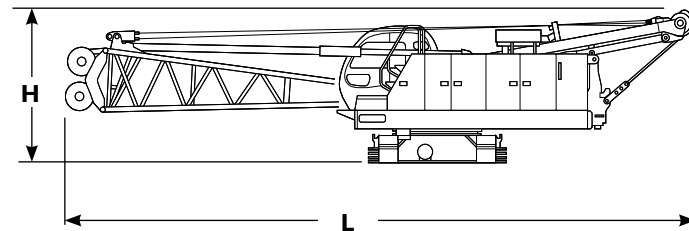

Upperworks without crawlers		x 1
Length	12,93 m	42' 5"
Width	3,50 m	11' 6"
Height	3,06 m	10' 0"
Weight	32 250 kg	71,100 lb

*Note: Weight includes base machine, crawler, maximum hoist and whip lines on drums, full hydraulic fluid reservoir, and one third tank of fuel.*

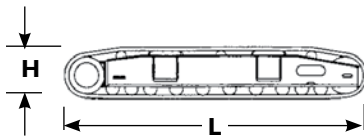

Crawlers		x 2
Length	6,30 m	20' 7"
Width	0,91 m	3' 0"
Height	0,98 m	3' 3"
Weight	7 950 kg	17,530 lb

Optional 3rd drum and wire rope		x 1
Weight	2 660 kg	5,865 lb

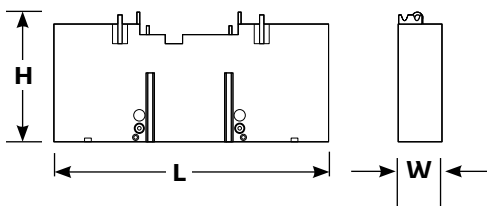

Upper counterweight series 1		x 1
Length	3,20 m	10' 6"
Width	0,64 m	2' 1"
Height	1,71 m	5' 7"
Weight	12 070 kg	27,626 lb

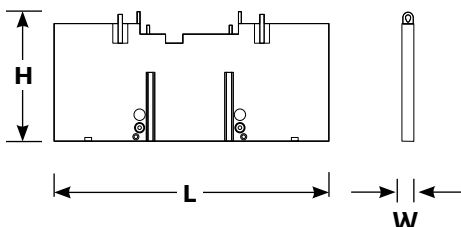

Upper counterweight series 2		x 1
Length	3,20 m	10' 6"
Width	0,52 m	1' 8"
Height	1,71 m	5' 7"
Weight	7 373 kg	16,254 lb

Option

# Outline dimensions

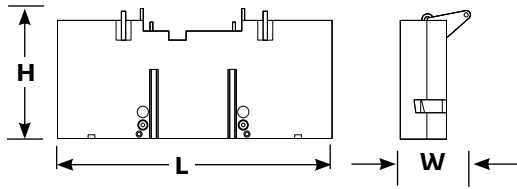

Upper counterweight series 3		x 1
Length	3,20 m	10' 6"
Width	0,80 m	2' 7"
Height	1,71 m	5' 7"
Weight	9 347 kg	20,606 lb

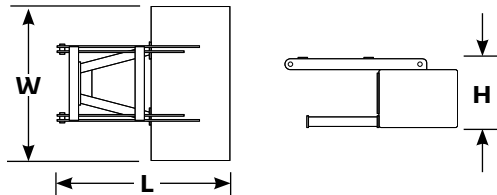

Carbody counterweight		x 2
Length	1,67 m	5' 6"
Width	1,25 m	4' 1"
Height	0,57 m	1' 10"
Weight	3 651 kg	8,050 lb

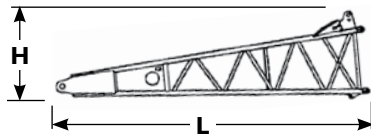

Boom butt 5,8 m (19')		x 1
Length	5,17 m	19' 7"
Width	1,50 m	4' 11"
Height	1,69 m	5' 7"
Weight	1140 kg	2,510 lb

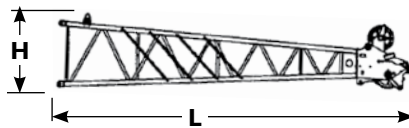

Boom top 6,4 m (21')		x 1
Length	6,91 m	22' 8"
Width	1,50 m	4' 11"
Height	1,48 m	4' 10"
Weight	1170 kg	2,580 lb

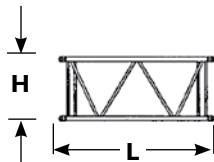

Boom insert 3,0 m (10')		x 1,2
Length	3,16 m	10' 5"
Width	1,50 m	4' 11"
Height	1,29 m	4' 3"
Weight	310 kg	680 lb

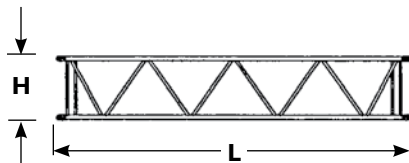

Boom insert 6,10 m (20')		x 1,2
Length	6,21 m	20' 4"
Width	1,50 m	4' 11"
Height	1,29 m	4' 3"
Weight	520 kg	1,150 lb

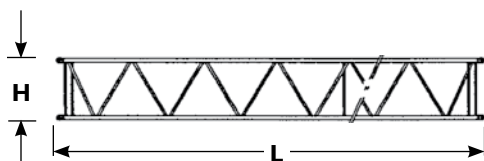

Boom insert 12,2 m (40')		x 1,2,3
Length	12,31 m	40' 4"
Width	1,50 m	4' 11"
Height	1,29 m	4' 3"
Weight	960 kg	2,120 lb

Note: Use one "A" type insert with lug required for any boom combinations that require a 12,2 m (40') insert.

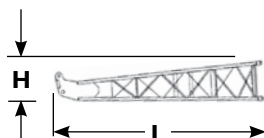

Fixed jib butt		x 1
Length	4,81 m	15' 9"
Width	0,79 m	2' 7"
Height	0,79 m	2' 7"
Weight	200 kg	440 lb

Option



# Outline dimensions

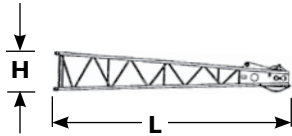

Fixed jib top x 1		
Length	4,96 m	16' 3"
Width	0,79 m	2' 7"
Height	0,79 m	2' 7"
Weight	280 kg	620 lb

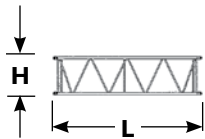

Fixed jib insert 3,0 (10') x 1		
Length	3,12 m	10' 3"
Width	0,79 m	2' 7"
Height	0,79 m	2' 7"
Weight	100 kg	220 lb

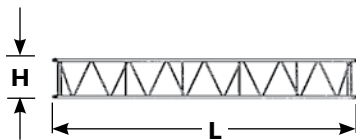

Fixed jib insert 6,1 m (20') x 1		
Length	6,16 m	20' 3"
Width	0,79 m	2' 7"
Height	0,79 m	2' 7"
Weight	180 kg	400 lb

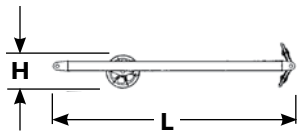

Fixed jib strut x 1		
Length	3,62 m	11' 11"
Width	0,84 m	2' 9"
Height	0,62 m	2' 2"
Weight	250 kg	550 lb

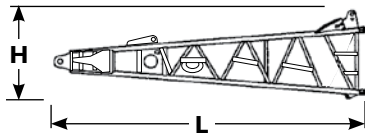

Luffing boom butt x 1		
Length	6,27 m	20' 7"
Width	1,67 m	5' 6"
Height	2,06 m	6' 9"
Weight	1540 kg	3,400 lb

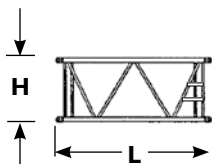

Luffing boom insert 3,0 m (10') x 1,2		
Length	3,16 m	10' 5"
Width	1,67 m	5' 6"
Height	1,67 m	5' 6"
Weight	395 kg	870 lb

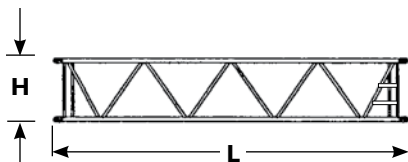

Luffing boom insert 6,10 m (20') x 1,2		
Length	6,21 m	20' 5"
Width	1,67 m	5' 6"
Height	1,67 m	5' 6"
Weight	665 kg	1,470 lb

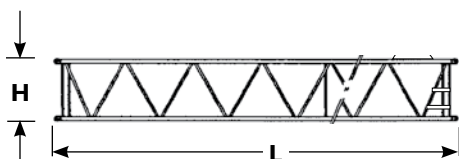

Luffing boom insert 9,14 m (30') x 1,2,3		
Length	9,26 m	30' 5"
Width	1,67 m	5' 6"
Height	1,67 m	5' 6"
Weight	935 kg	2,060 lb

Option

# Outline dimensions

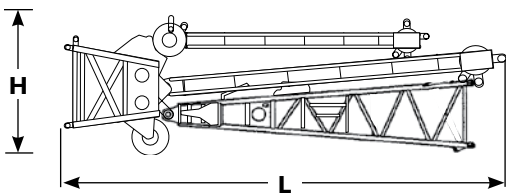
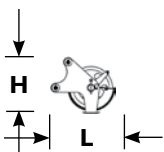
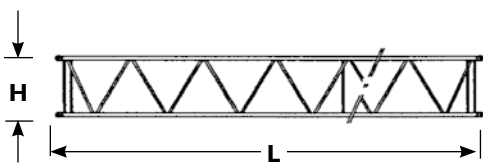
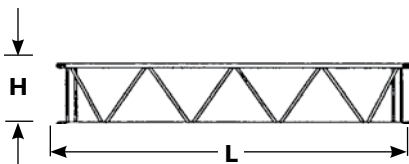
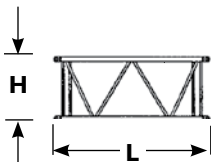
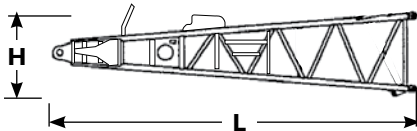
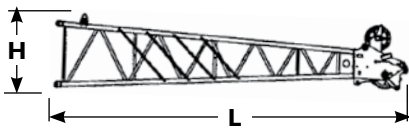
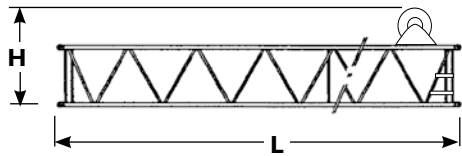

<b>Luffing special boom insert</b>	<b>x 1</b>	
9,14 m (30')		
Length	9,26 m	30' 5"
Width	1,67 m	5' 6"
Height	2,41 m	7' 11"
Weight	1160 kg	2,560 lb

<b>Luffing jib top</b>	<b>x 1</b>	
Length	6,91 m	22' 8"
Width	1,49 m	4' 11"
Height	1,48 m	4' 10"
Weight	1170 kg	2,580 lb

<b>Luffing jib butt</b>	<b>x 1</b>	
Length	5,97 m	19' 7"
Width	1,49 m	4' 11"
Height	1,32 m	4' 4"
Weight	863 kg	1,900 lb

<b>Luffing jib insert 3,0 m (10')</b>	<b>x 1,2</b>	
Length	3,16 m	10' 5"
Width	1,49 m	4' 11"
Height	1,29 m	4' 3"
Weight	310 kg	685 lb

<b>Luffing jib insert 6,10 m (20')</b>	<b>x 1,2</b>	
Length	6,21 m	20' 5"
Width	1,49 m	4' 11"
Height	1,29 m	4' 3"
Weight	520 kg	1,150 lb

<b>Luffing jib insert 12,2 m (40')</b>	<b>x 1,2,3</b>	
Length	12,31 m	40' 4"
Width	1,49 m	4' 11"
Height	1,29 m	4' 3"
Weight	960 kg	2,120 lb

<b>Luffing jib point roller assembly</b>	<b>x 1</b>	
Length	1,01 m	3' 4"
Width	0,89 m	2' 11"
Height	0,91 m	3' 0"
Weight	380 kg	840 lb

<b>Luffing boom top assembly (shipping style)</b>	<b>x 1</b>	
Length	8,19 m	26' 10"
Width	1,98 m	6' 6"
Height	2,65 m	8' 8"
Weight	3 500 kg	7,720 lb

Option

# Crane assembly

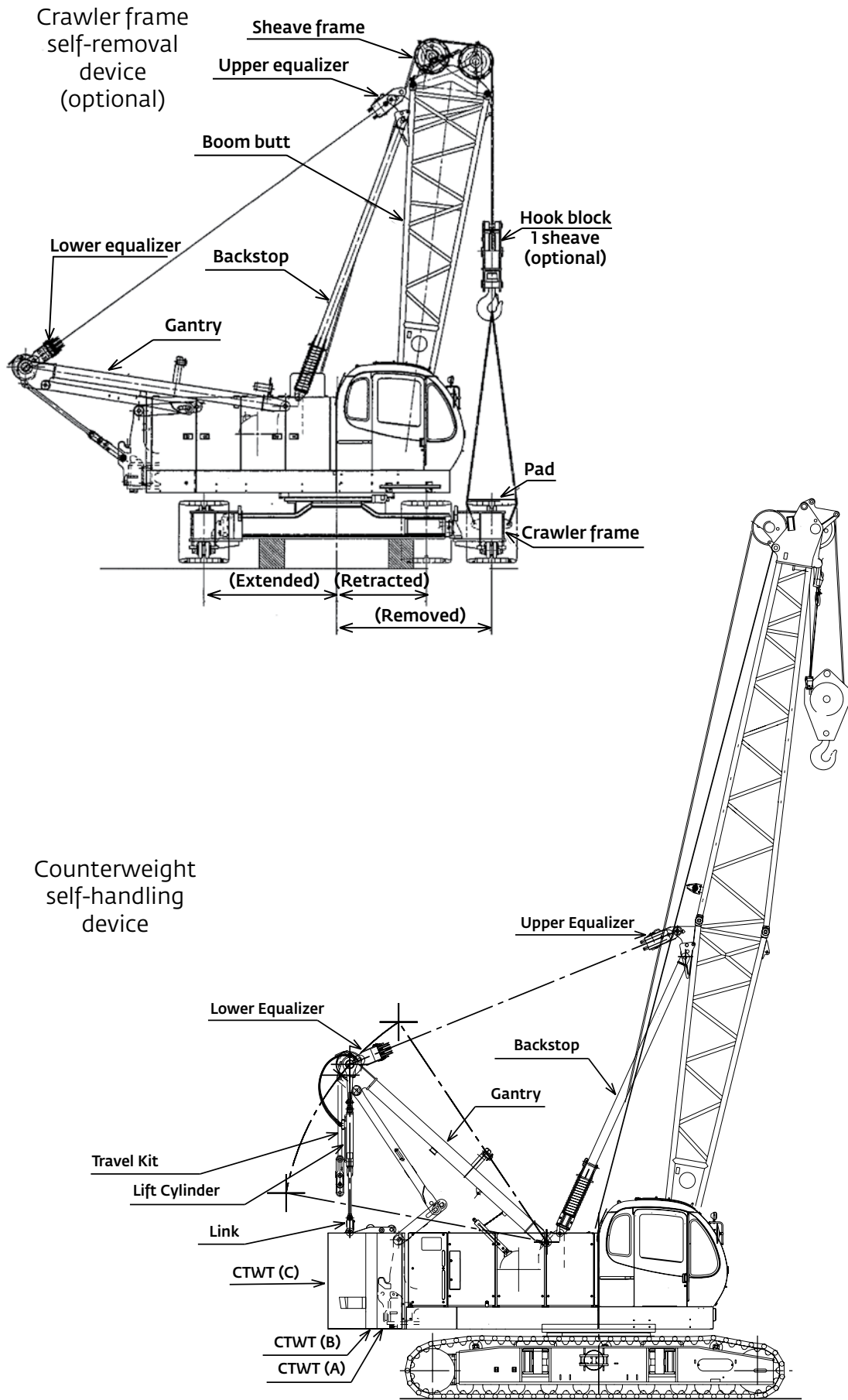

# Winch performance data

Line pull		
	Rated line pull kg (lb)	*Maximum line pull kg (lb)
Front drum	11 400 (25,100)	20,000 (44,100)
Rear drum	11 400 (25,100)	20,000 (44,100)
Optional 3rd drum	11 400 (25,100)	20,000 (44,100)

\* Maximum line pull is not based on wire rope strength.

Wire rope specifications				
Use	Specs	Diameter mm (in)	Working length m (ft)	Breaking strength kg (lb)
Front drum	IWRC C/O 6 X Fi (29)	26,0 (1.02)	235 (771)	54 430 (120,000)
Rear drum	IWRC C/O 6 X Fi (29)	26,0 (1.02)	160 (525)	54 430 (120,000)
Boom hoist drum	IWRC C/O 6 X Fi (31)	16,0 (5/8)	150 (492)	21 410 (47,200)
Optional 3rd drum	IWRC C/O 6 X Fi (29)	26,0 (1.02)	190 (623)	54 430 (120,000)

Front and rear winch						
Layer		Line speed m/min (ft/min)				
		1	2	3	4	5
Rated line pull	Single line pull kg (lb)					
	0 (0)	125 (410)	133 (436)	142 (466)	151 (495)	160 (525)
	2 268 (5,000)	124 (406)	132 (434)	141 (463)	150 (492)	159 (522)
	4 536 (10,000)	108 (355)	108 (355)	108 (355)	108 (355)	108 (355)
	6 804 (15,000)	72 (237)	72 (237)	72 (237)	72 (237)	72 (237)
	9 072 (20,000)	54 (177)	54 (177)	54 (177)	54 (177)	54 (177)
	11 340 (25,000)	43 (142)	43 (142)	43 (142)	43 (142)	43 (142)
	13 608 (30,000)	36 (118)	36 (118)	36 (119)	38 (126)	41 (133)
	15 876 (35,000)	32 (104)	34 (111)	36 (118)	38 (125)	–
	18 144 (40,000)	32 (104)	34 (111)	–	–	–

NOTE: Line speeds and line pull based on single line.  
Line pulls are not based on wire rope strength.

# Load chart notes

- Rated loads included in the charts are the maximum allowable freely suspended loads at a given boom length, boom angle and load radius, and have been determined for the machine standing level on firm supporting surface under ideal operating conditions. The user must limit or de-rate rated loads to allow for adverse conditions (such as soft or uneven ground, out-of-level conditions, wind side loads, pendulum action, jerking or sudden stopping of loads, inexperience of personnel, multiple machine lifts, and traveling with a load).
- Capacities do not exceed 75% of minimum tipping loads. Capacities based on factors other than machine stability such as structural competence are shown by asterisk \* in the charts located in the operator's crane cab.
- The machine must be reeved and set-up as stated in the operation manual and all the instruction manuals. If these manuals are missing, obtain replacements. Boom backstops are required for all boom lengths. Gantry must be in the fully raised position for all operations. Crawlers must be fully extended and be locked in position. The crane must be leveled to within 1% on a firm supporting surface.
- Do not attempt to lift where no radius or load is listed as crane may tip or collapse.
- Attempting to lift more than rated loads may cause machine to tip or collapse. Do not tip machine to determine capacity.
- Weight of hooks, hook blocks, slings and other lifting devices are a part of the total load. Their total weight must be subtracted from the rated load to obtain the weight that can be lifted.
- When lifting over boom point with jib or upper boom point installed, rated loads for the boom must be deducted as shown below.

Jib length m (ft)	Upper boom point	9,1 (30)	12,2 (40)	15,2 (50)	18,3 (60)
Deduct kg (lb)	200 (420)	1100 (2,400)	1500 (3,200)	2 000 (4,200)	2 400 (5,200)

When lifting over luffing jib point with luffing jib roller assembly or pin connected boom point sheave (on the luffing boom top) attached, rated loads for the jib and sheave must be deducted as shown below.

	Luffing jib point roller	Pin connected boom point sheave
Deduct kg (lb)	400 (850)	200 (480)

- The total load that can be lifted by the fixed jib is limited by rated jib loads. The total load that can be lifted with the upper boom point is limited by rated auxiliary sheave loads.

- Boom lengths for fixed jib mounting are 24,4 m (80 ft) to 57,9 m (190 ft).
- The total load that can be lifted by the upper boom point is: the rated load for the boom (without upper boom point installed) minus 191 kg (420 lb); however, the upper boom point rated load should not exceed 10 900 kg (24,000 lb).
- An upper boom point cannot be used on a 61 m (200 ft) boom length.
- The boom should be erected over the front of the crawlers, not laterally. When erecting and lowering the boom with a length of 57,9 m (190 ft) with jib, blocking must be placed at the end of the crawlers. See operator's manual for details.
- Least stable position is over the side.
- Maximum hoist load for number of reeving parts of line for hoist rope.

## Maximum load for main boom

No. of parts of line	1	2	3	4	5
Maximum loads kg (lb)	11 300 (25,000)	22 600 (50,000)	33 900 (75,000)	45 200 (100,000)	56 500 (125,000)

No. of parts of line	6	7	8
Maximum loads kg (lb)	67 800 (150,000)	79 100 (175,000)	90 000 (200,000)

## Maximum load for luffing jib

No. of parts of line	1	2	4
Maximum loads kg (lb)	11 300 (25,000)	22 700 (50,000)	36 300 (80,000)

\* 3 part line not recommended for luffing jib.

## Maximum load for fixed jib

No. of parts of line	1
Maximum loads kg (lb)	10 800 (24,000)

## Maximum load for upper boom point

No. of parts of line	1
Maximum loads kg (lb)	10 900 (24,000)

## Minimum weight of hook block required for lowering. (Luffing jib use)

No. of parts of line	1	2	4
Maximum loads kg (lb)	272 (600)	544 (1,200)	680 (1,500)

- Lifting capacities listed apply only to the machine as originally manufactured for and supplied by Manitowoc Cranes, Inc. Modifications to this machine or use of equipment other than that specified can reduce operating capacity.
- Designed and rated to comply with ANSI Code B30.5.

Operation of this equipment in excess of rated loads or disregard of instruction voids the warranty.

# Boom combinations

## No. 10000 heavy-lift boom combinations

Boom length m (ft)	Boom inserts		
	3,1 m (10 ft)	6,1 m (20 ft)	12,2 m (40 ft)
12,2 (40)	–	–	–
15,2 (50)	1	–	–
18,3 (60)	2	–	–
21,3 (70)	1	1	–
24,4 (80)	2	1	–
27,4 (90)	1	2	–
30,5 (100)	2	2	–
33,5 (110)	1	1	1*
36,6 (120)	2	1	1*
39,6 (130)	1	2	1*
42,7 (140)	2	2	1*
45,7 (150)	1	1	2*
48,8 (160)	2	1	2*
51,8 (170)	1	2	2*
54,9 (180)	2	2	2*
57,9 (190)	1	1	3*
61,0 (200)	2	1	3*

\* NOTE: One 40 ft (12,20 m) boom insert with lug 40A is required for fixed jib. When no jib is installed a 40 ft (12,20 m) boom can be used instead of 40A.

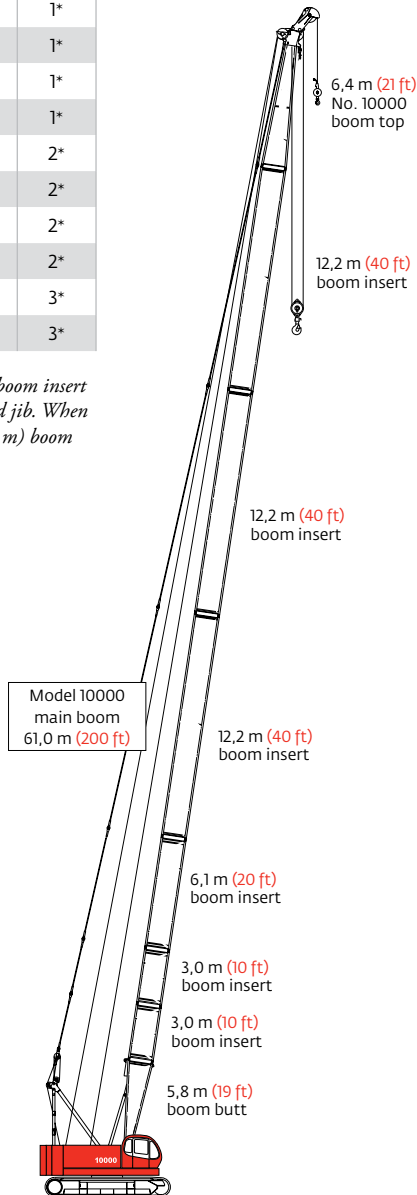

**Model 10000**  
Main boom 61,0 m (200 ft)

## No. 10000 fixed jib combinations

Fixed jib length m (ft)	Fixed jib inserts	
	3,1 m (10 ft)	6,1 m (20 ft)
9,1 (30)	–	–
12,2 (40)	1	–
15,2 (50)	–	1
18,3 (60)	1	1

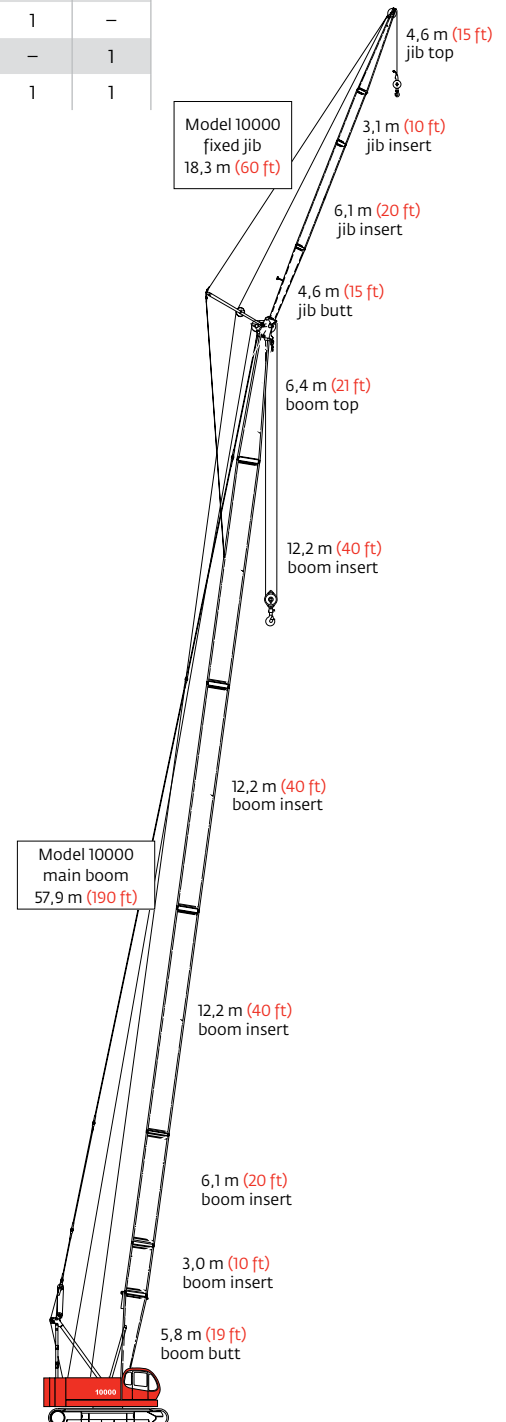

**Model 10000**  
Fixed jib on main boom  
76,2 m (250 ft)

# Boom combinations

## No. 10000 luffing jib combinations

Boom length m (ft)	Boom inserts		
	3,0 m (10 ft)	6,1 m (20 ft)	12,2 m (40 ft)
15,2 (50)	1	–	–
18,3 (60)	2	–	–
21,3 (70)	1	1	–
24,4 (80)	2	1	–
27,4 (90)	1	2	–
30,5 (100)	2	2	–
33,5 (110)	1	1	1
36,6 (120)	2	1	1
39,6 (130)	1	2	1
42,7 (140)	2	2	1
45,7 (150)	1	1	2
48,8 (160)	2	1	2
51,8 (170)	1	2	2

## No. 10000 luffing boom combinations

Boom length m (ft)	Boom inserts		
	3,0 m (10 ft)	6,1 m (20 ft)	9,1 m (30 ft)
16,7 (55)	–	–	1
19,8 (65)	1	–	1
22,8 (75)	2	–	1
25,9 (85)	1	1	1
28,9 (95)	2	1	1
32,0 (105)	2	–	2
35,0 (115)	1	1	2

NOTE: One 9,14 m (30') special luffing boom insert is required for luffing boom.

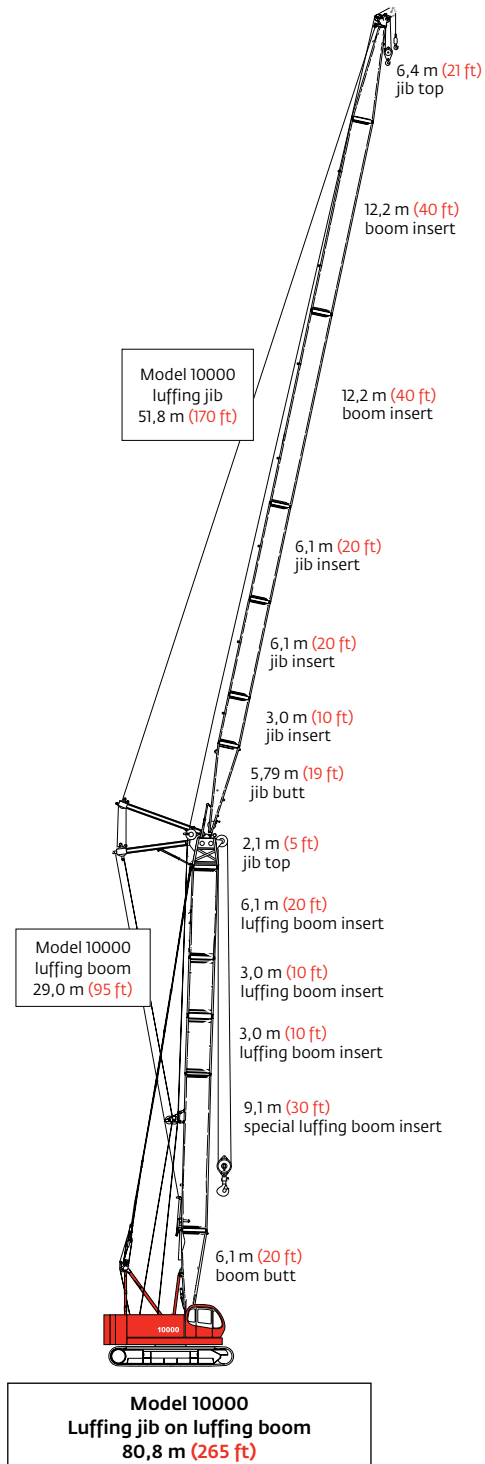

# Heavy-lift boom range diagram

No. 10000 main boom

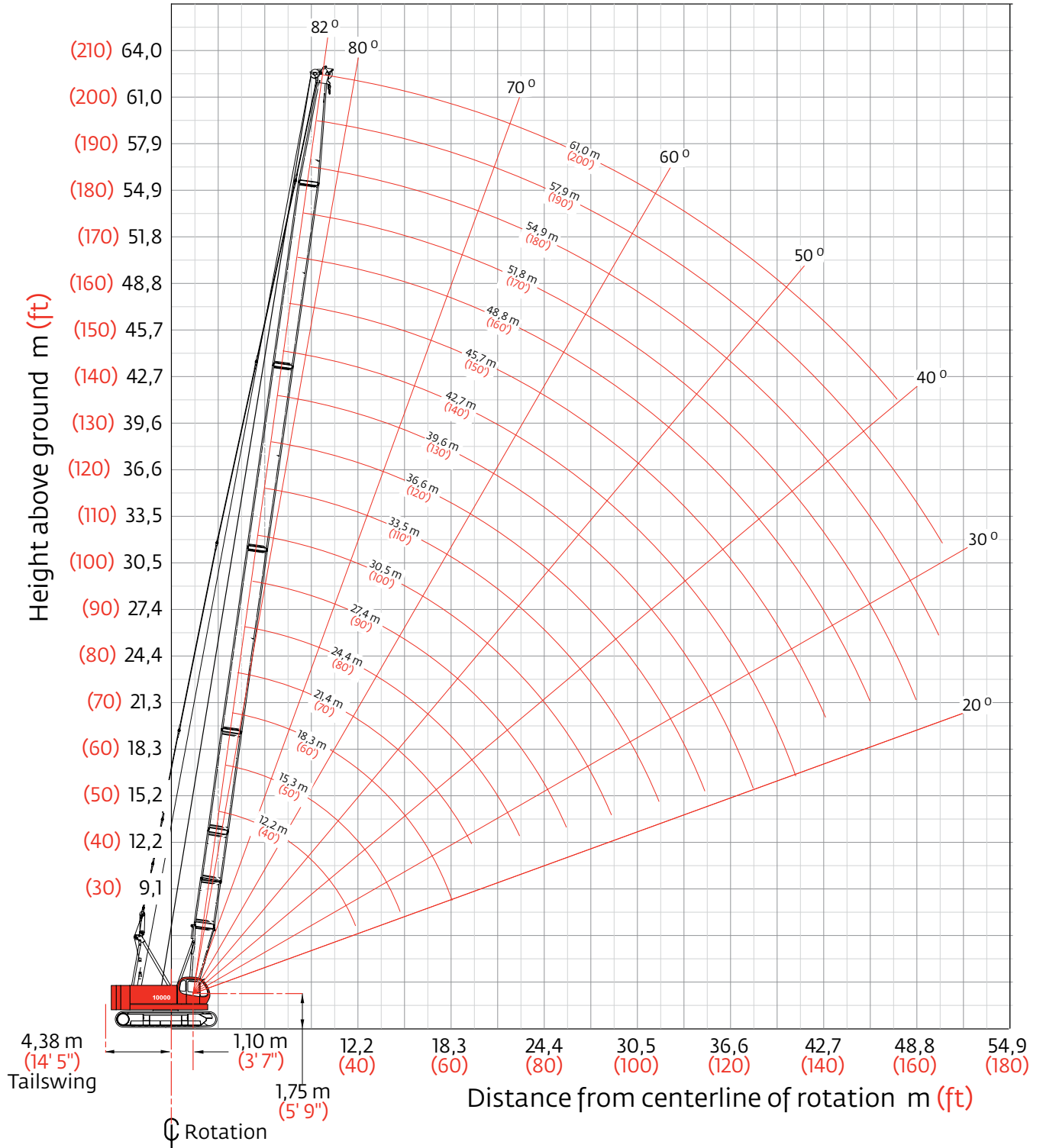



# Heavy-lift boom load charts

## Model 10000 Series 3 liftcrane boom capacities - No. 10000 main boom

28 800 kg (63,500 lb) upper counterweight, 7 300 kg (16,100 lb) carbody counterweight crawler extended

360° Rating

kg (lb) x 1 000

Boom m (ft)	12,2 (40)	15,2 (50)	18,3 (60)	21,3 (70)	24,4 (80)	27,4 (90)	30,5 (100)	33,5 (110)	36,6 (120)	39,6 (130)	42,7 (140)	45,7 (150)	48,8 (160)	51,8 (170)	54,9 (180)	57,9 (190)	61,0 (200)
Radius																	
3,1 (10)	90,0 (200.0)																
3,5 (12)	87,5 (185.4)	— (185.1)															
4,0 (14)	77,4 (160.2)	— (160.0)	77,2 (159.8)														
4,5 (16)	69,2 (141.0)	77,3 (140.8)	69,0 (140.6)	— (140.4)	— (138.6)												
5,5 (18)	57,2 (126.1)	69,1 (125.8)	56,2 (124.3)	55,4 (122.5)	53,9 (119.2)	53,2 (117.7)											
6,0 (20)	51,5 (111.1)	56,9 (111.3)	50,5 (109.1)	49,8 (107.5)	48,4 (104.7)	47,7 (103.1)	46,6 (100.7)	— (100.3)									
7,0 (24)	41,7 (86.4)	51,6 (87.5)	41,8 (87.3)	41,4 (86.4)	40,3 (84.2)	39,6 (82.6)	38,6 (80.6)	38,4 (80.0)	37,6 (78.4)	— (71.8)	— (61.7)						
8,0 (28)	34,4 (69.0)	42,3 (70.1)	34,7 (69.8)	34,7 (69.8)	34,3 (69.4)	33,8 (69.2)	32,9 (67.4)	32,6 (66.7)	31,9 (65.2)	31,8 (65.0)	27,5 (59.9)	— (51.8)	— (44.0)	— (38.8)			
10,0 (34)	24,3 (50.2)	34,8 (53.7)	25,5 (53.5)	25,4 (53.3)	25,3 (53.1)	25,2 (52.9)	25,1 (52.6)	25,1 (52.6)	24,7 (52.2)	24,5 (51.8)	24,0 (50.7)	22,6 (49.6)	19,2 (42.1)	16,9 (37.0)	14,9 (32.6)	13,3 (28.8)	— (25.7)
12,0 (40)	16,6 (35.2)	25,6 (43.4)	20,0 (43.2)	19,9 (42.9)	19,8 (42.7)	19,7 (42.5)	19,6 (42.3)	19,6 (42.3)	19,5 (42.1)	19,4 (41.8)	19,3 (41.6)	19,0 (41.2)	18,3 (40.3)	16,0 (35.2)	14,1 (31.0)	12,5 (27.5)	11,1 (24.4)
14,0 (45)		20,1 (35.2)	16,4 (37.0)	16,3 (37.0)	16,2 (36.5)	16,1 (36.3)	16,0 (36.1)	16,0 (36.1)	15,8 (35.9)	15,8 (35.7)	15,7 (35.4)	15,6 (35.2)	15,6 (35.2)	15,1 (33.9)	13,4 (29.7)	11,9 (26.4)	10,5 (23.3)
16,0 (55)		15,3 (—)	13,5 (27.3)	13,8 (28.6)	13,6 (28.2)	13,5 (27.9)	13,4 (27.7)	13,4 (27.7)	13,2 (27.3)	13,2 (27.3)	13,1 (27.1)	13,0 (26.8)	13,0 (26.8)	12,9 (26.6)	12,4 (26.2)	11,2 (24.2)	9,9 (21.3)
22,0 (75)					8,8 (17.8)	8,9 (18.7)	8,7 (18.2)	8,7 (18.2)	8,6 (18.0)	8,5 (17.8)	8,4 (17.6)	8,3 (17.4)	8,3 (17.4)	8,2 (17.1)	8,1 (16.7)	8,0 (16.7)	7,4 (15.6)
28,0 (95)							6,1 (12.3)	6,3 (13.2)	6,1 (13.0)	6,1 (12.7)	5,9 (12.5)	5,9 (12.3)	5,8 (12.1)	5,7 (11.9)	5,6 (11.6)	5,5 (11.4)	5,4 (11.2)
32,0 (105)								— (10.3)	5,1 (11.2)	5,0 (11.0)	4,9 (10.8)	4,8 (10.5)	4,7 (10.3)	4,6 (10.1)	4,5 (9.9)	4,4 (9.7)	4,2 (9.4)
34,0 (115)									4,3 (8.5)	4,5 (9.4)	4,4 (9.2)	4,3 (9.0)	4,3 (9.0)	4,2 (8.8)	4,0 (8.3)	4,0 (8.3)	3,8 (7.9)
38,0 (125)										3,2 (7.0)	3,5 (7.7)	3,6 (7.9)	3,5 (7.7)	3,4 (7.4)	3,3 (7.2)	3,2 (7.0)	3,0 (6.6)
40,0 (135)											2,9 (5.7)	3,2 (6.6)	3,2 (6.8)	3,1 (6.6)	3,0 (6.1)	2,9 (6.1)	2,6 (5.2)
44,0 (145)													2,4 (5.2)	2,5 (5.5)	2,4 (5.2)	2,4 (5.2)	1,9 (4.1)
46,0 (155)														2,1 (4.1)	2,1 (4.1)	2,1 (4.1)	1,5 (3.0)
50,0 (165)															1,4 (3.0)	1,5 (3.3)	

For complete chart, refer to [www.cranelibrary.com](http://www.cranelibrary.com).

Meets ANSI B30.5 Requirements - Capacities do not exceed 75% of static tipping load.  
NOTICE: This capacity chart is for reference only and must not be used for lifting purposes.

# Fixed jib range diagram

No. 10000 fixed jib on main boom

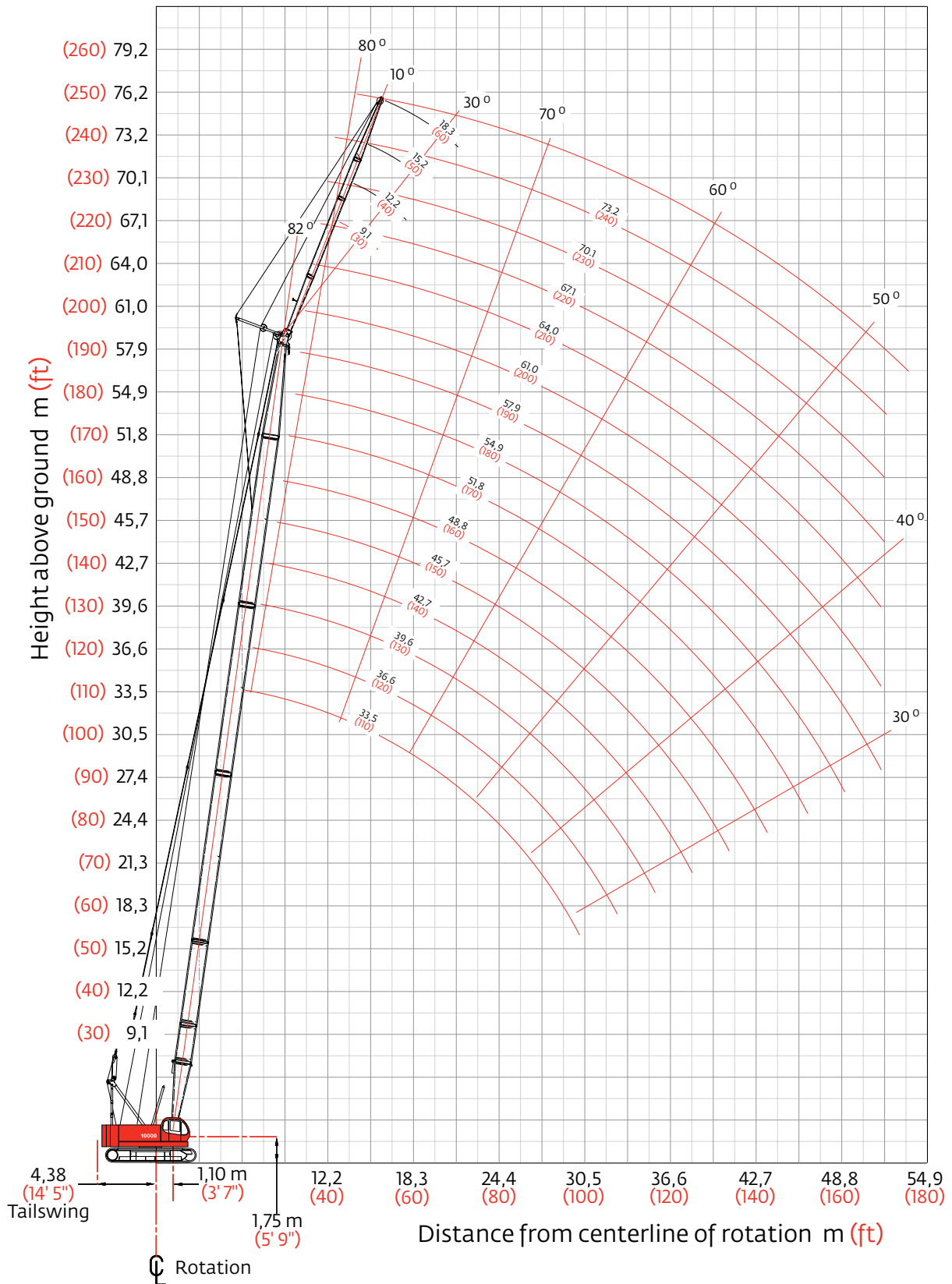

# Fixed jib load charts

## Model 10000 series 3 liftcrane jib capacities No. 10000 fixed jib on main boom

28 800 kg (63,500 lb) upper counterweight, 7 300 kg (16,100 lb) carbody counterweight crawler extended  
360° Rating kg (lb) x 1 000

		10° offset					30° offset					
		24,4 (80)	30,5 (100)	39,6 (130)	48,8 (160)	57,9 (190)	24,4 (80)	30,5 (100)	39,6 (130)	48,8 (160)	57,9 (190)	
jib 9,1 m (30 ft)	Radius											
	10,0 (30)	10,8 (24.0)					10,0 (30)					
	12,0 (40)	10,8 (24.0)	10,8 (24.0)	10,8 (24.0)			12,0 (40)	9,5 (21.0)				
	14,0 (50)	10,8 (24.0)	10,8 (24.0)	10,8 (24.0)	10,8 (24.0)	— (19.4)	14,0 (50)	9,2 (19.5)	9,4 (20.6)	— (21.0)		
	18,0 (60)	10,8 (24.0)	10,8 (24.0)	10,8 (24.0)	10,7 (23.7)	8,4 (18.6)	18,0 (60)	8,0 (17.5)	8,5 (18.6)	9,2 (20.1)	9,5 (21.0)	8,2 (18.2)
	24,0 (80)	8,0 (17.3)	7,8 (16.8)	7,4 (16.1)	7,2 (15.5)	6,9 (14.8)	24,0 (80)	6,7 (14.8)	7,3 (15.9)	7,6 (16.6)	7,4 (16.0)	7,2 (15.5)
	30,0 (100)	5,9 (12.8)	5,7 (12.2)	5,3 (11.5)	5,0 (10.9)	4,7 (10.2)	30,0 (100)		6,0 (—)	5,4 (11.8)	5,2 (11.2)	4,9 (10.6)
	36,0 (120)		4,5 (—)	3,9 (8.5)	3,7 (7.9)	3,3 (7.2)	36,0 (120)				3,8 (8.2)	3,5 (7.5)
	42,0 (140)			2,9 (6.1)	2,7 (5.8)	2,3 (4.8)	42,0 (140)					2,4 (5.2)
	44,0 (150)			2,7 (—)	2,4 (4.7)	2,0 (3.9)	44,0 (150)					2,1 (4.2)
	48,0 (160)				1,7 (3.6)	1,5 (—)	48,0 (160)					
52,0 (170)				1,4 (—)		52,0 (170)						
jib 12,2 m (40 ft)	Radius											
	10,0 (30)	10,8 (—)	10,8 (—)				10,0 (30)					
	12,0 (40)	10,8 (24.0)	10,8 (24.0)	10,8 (—)			12,0 (40)	6,9 (14.4)	— (15.1)			
	14,0 (50)	10,8 (24.0)	10,8 (24.0)	10,8 (24.0)	10,8 (24.0)		14,0 (50)	6,8 (12.9)	6,8 (13.6)	— (14.5)	— (15.1)	
	18,0 (60)	9,5 (20.7)	10,6 (23.2)	10,8 (24.0)	10,8 (24.0)	8,4 (18.5)	18,0 (60)	5,9 (10.9)	6,2 (11.6)	6,6 (12.5)	6,8 (13.2)	— (13.8)
	24,0 (80)	7,2 (15.6)	7,9 (17.0)	7,5 (16.3)	7,3 (15.7)	7,0 (15.1)	24,0 (80)	5,0 (—)	5,3 (10.3)	5,7 (11.1)	6,0 (11.6)	6,3 (11.0)
	30,0 (100)	5,8 (12.6)	5,7 (12.4)	5,4 (11.7)	5,1 (11.1)	4,8 (10.4)	30,0 (100)		4,7 (—)	5,0 (8.9)	5,3 (8.4)	5,1 (7.8)
	36,0 (120)		4,4 (9.4)	4,0 (8.7)	3,7 (8.0)	3,4 (7.3)	36,0 (120)			4,1 (—)	3,9 (6.2)	3,6 (5.5)
	42,0 (140)			3,1 (6.6)	2,8 (5.9)	2,4 (5.0)	42,0 (140)				2,9 (—)	2,6 (4.4)
	44,0 (150)			2,7 (5.3)	2,5 (5.0)	2,1 (4.1)	44,0 (150)					2,3 (—)
	48,0 (160)				1,9 (4.0)	1,5 (3.2)	48,0 (160)					1,8 (—)
52,0 (170)				1,4 (3.1)		52,0 (170)						

For complete chart, refer to [www.cranellibrary.com](http://www.cranellibrary.com).

Meets ANSI B30.5 Requirements - Capacities do not exceed 75% of static tipping load.  
NOTICE: This capacity chart is for reference only and must not be used for lifting purposes.

# Fixed jib load charts

## Model 10000 series 3 liftcrane jib capacities No. 10000 fixed jib on main boom

28 800 kg (63,500 lb) upper counterweight, 7 300 kg (16,100 lb) carbody counterweight crawler extended  
360° Rating kg (lb) x 1 000

		10° offset					30° offset				
		24,4 (80)	30,5 (100)	39,6 (130)	48,8 (160)	57,9 (190)	24,4 (80)	30,5 (100)	39,6 (130)	48,8 (160)	57,9 (190)
jib 15,2 m (50 ft)	Radius										
	10,0 (30)										
	12,0 (40)	9,0 (20.0)	9,0 (20.0)								
	14,0 (50)	9,0 (20.0)	9,0 (20.0)	9,0 (20.0)							
	18,0 (60)	7,8 (17.0)	8,6 (18.9)	9,0 (20.0)	9,0 (20.0)	8,1 (18.4)	4,8 (10.4)	5,0 (10.9)	5,2 (11.4)		
	24,0 (80)	5,9 (12.8)	6,6 (14.4)	7,6 (16.5)	7,4 (15.9)	7,1 (15.3)	4,0 (8.7)	4,2 (9.2)	4,5 (9.8)	4,7 (10.3)	4,9 (10.7)
	30,0 (100)	4,7 (10.3)	5,3 (11.6)	5,5 (11.8)	5,2 (11.2)	4,9 (10.5)	3,4 (7.6)	3,7 (8.0)	3,9 (8.7)	4,2 (9.2)	4,4 (9.6)
	36,0 (120)	4,1 (—)	4,4 (9.5)	4,1 (8.8)	3,8 (8.2)	3,5 (7.5)			3,5 (7.6)	3,8 (8.3)	3,8 (8.1)
	42,0 (140)		3,5 (—)	3,1 (6.7)	2,8 (6.1)	2,4 (5.2)				3,0 (6.4)	2,7 (5.7)
	44,0 (150)			2,9 (5.8)	2,5 (5.2)	2,1 (4.2)				2,7 (5.5)	2,4 (4.7)
	48,0 (160)			2,2 (4.6)	2,0 (4.3)	1,6 (—)					1,8 (3.8)
	52,0 (170)				1,5 (3.4)						

		24,4 (80)	30,5 (100)	39,6 (130)	48,8 (160)	57,9 (190)	24,4 (80)	30,5 (100)	39,6 (130)	48,8 (160)	57,9 (190)
jib 18,3 m (60 ft)	Radius										
	10,0 (30)										
	12,0 (40)	8,1 (18.0)									
	14,0 (50)	8,1 (17.8)	8,1 (18.0)	— (18.0)							
	18,0 (60)	6,8 (14.8)	7,5 (16.3)	8,1 (18.0)	8,1 (18.0)	8,1 (18.0)	4,0 (8.9)				
	24,0 (80)	5,1 (11.1)	5,6 (12.3)	6,4 (14.1)	7,2 (15.6)	7,2 (15.4)	3,3 (7.3)	3,5 (7.7)	3,7 (8.1)	3,9 (8.5)	3,9 (8.7)
	30,0 (100)	4,0 (8.8)	4,5 (9.9)	5,2 (11.4)	5,2 (11.3)	4,9 (10.7)	2,8 (6.2)	3,0 (6.6)	3,2 (7.1)	3,4 (7.5)	3,5 (7.8)
	36,0 (120)	3,4 (7.3)	3,8 (8.2)	4,1 (8.9)	3,8 (8.3)	3,5 (7.5)		2,7 (5.9)	2,9 (6.3)	3,1 (6.7)	3,2 (7.0)
	42,0 (140)		3,2 (7.1)	3,1 (6.8)	2,9 (6.1)	2,4 (5.2)			2,6 (5.8)	2,8 (6.2)	2,7 (5.9)
	44,0 (150)		3,1 (—)	2,9 (6.0)	2,6 (5.3)	2,1 (4.3)				2,7 (5.7)	2,4 (4.9)
	48,0 (160)			2,4 (5.0)	2,1 (4.4)	1,6 (3.4)				2,3 (4.9)	1,9 (4.0)
	52,0 (170)			— (4.0)	1,6 (3.6)						1,4 (3.2)

For complete chart, refer to [www.cranelibrary.com](http://www.cranelibrary.com).

Meets ANSI B30.5 Requirements - Capacities do not exceed 75% of static tipping load.  
NOTICE: This capacity chart is for reference only and must not be used for lifting purposes.

# Luffing jib range diagram

No. 10000 luffing jib on luffing boom

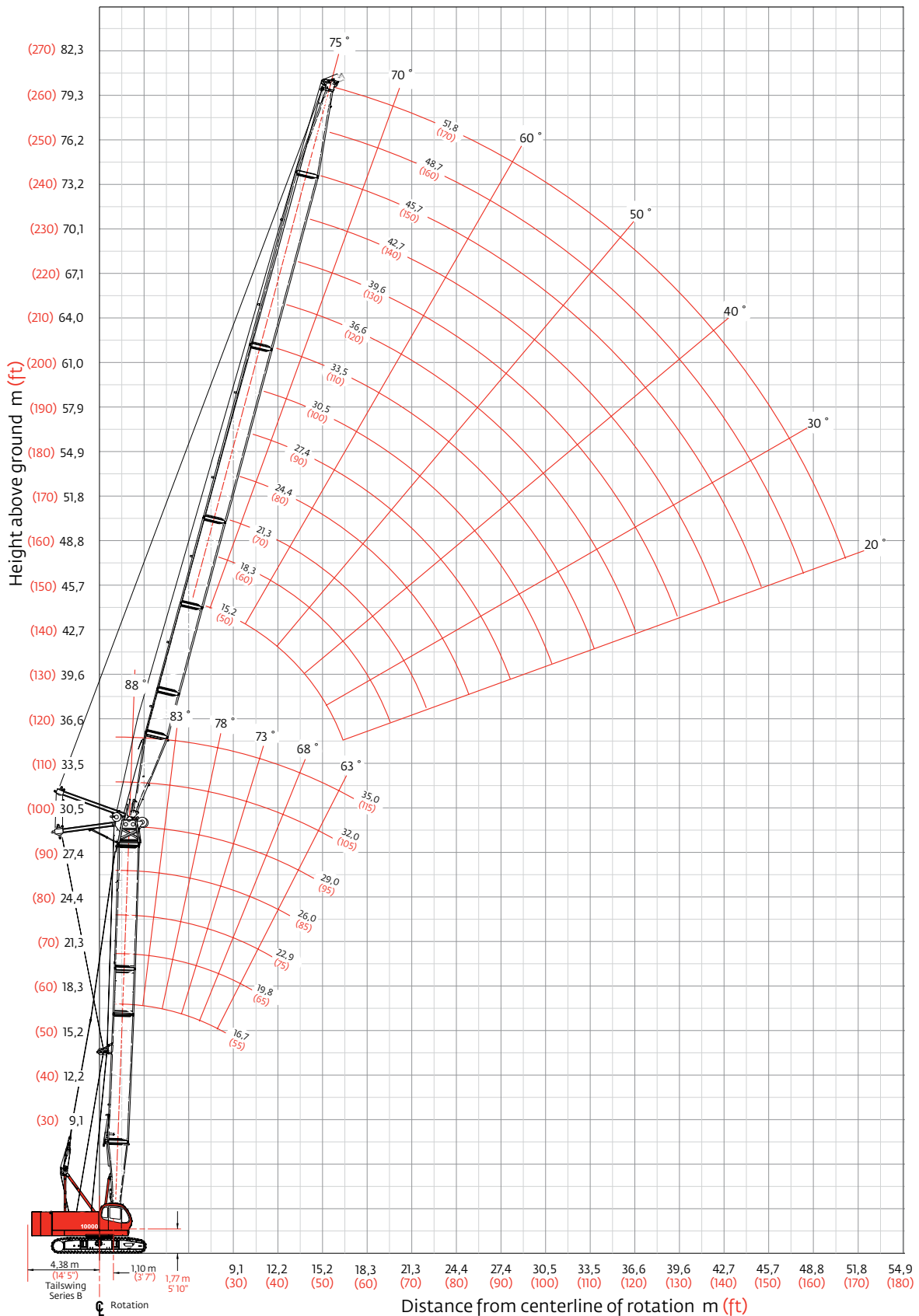

# Luffing jib load charts

## Model 10000 series 3 liftcrane luffing jib capacities

### No. 10000 luffing jib on luffing boom

28 800 kg (63,500 lb) upper counterweight, 7 300 kg (16,100 lb) carbody counterweight crawler extended

360° Rating

kg (lb) x1 000

### 88° boom angle

	Boom m (ft)	16,7 (55)	22,8 (75)	28,9 (95)	35,0 (115)
	Radius				
Luffing jib length 15,2 m (50 ft)	6,7 (22)	36,3 (80.0)			
	8,0 (26)	30,2 (67.5)	30,1 (67.3)	29,9 (66.8)	
	9,0 (30)	26,9 (58.6)	26,8 (58.3)	26,5 (57.9)	26,4 (57.5)
	10,0 (35)	24,2 (49.8)	24,0 (49.5)	23,8 (49.0)	23,7 (48.7)
	12,0 (40)	20,1 (43.6)	20,0 (43.4)	19,8 (42.9)	19,6 (42.5)
	14,0 (45)	17,2 (38.8)	17,1 (38.5)	16,9 (38.1)	16,7 (37.7)
	18,0 (60)				
	20,0 (65)				
	24,0 (80)				
	28,0 (95)				

	Boom m (ft)	16,7 (55)	22,8 (75)	28,9 (95)	35,0 (115)
	Radius				
Luffing jib length 27,4 m (90 ft)	6,7 (22)				
	8,0 (26)				
	9,0 (30)				
	10,0 (35)	23,4 (48.9)	— (48.9)	— (48.4)	— (48.0)
	12,0 (40)	19,7 (42.9)	19,7 (42.5)	19,4 (42.2)	19,2 (41.8)
	14,0 (45)	16,9 (38.1)	16,8 (37.9)	16,6 (37.4)	16,4 (37.0)
	18,0 (60)	12,2 (26.2)	12,1 (26.0)	12,1 (26.0)	12,0 (25.8)
	20,0 (65)	10,6 (23.6)	10,5 (23.6)	10,5 (23.4)	10,4 (23.1)
	24,0 (80)	8,3 (17.9)	8,2 (17.6)	8,2 (17.6)	8,1 (17.4)
	28,0 (95)	6,7 (—)	6,7 (—)	6,6 (13.9)	6,5 (13.7)

	Boom m (ft)	16,7 (55)	22,8 (75)	28,9 (95)
	Radius			
Luffing jib length 39,6 m (130 ft)	10,0 (36)			
	12,0 (40)			
	14,0 (45)	16,6 (37.5)	16,4 (37.0)	16,3 (36.8)
	18,0 (60)	11,8 (25.6)	11,8 (25.4)	11,7 (25.4)
	24,0 (80)	7,9 (17.0)	7,9 (17.0)	7,9 (17.0)
	26,0 (90)	7,1 (14.6)	7,0 (14.3)	7,0 (14.3)
	30,0 (100)	5,7 (12.3)	5,7 (12.3)	5,7 (12.1)
	32,0 (110)	5,2 (10.6)	5,2 (10.6)	5,1 (10.6)
	40,0 (130)	3,7 (8.2)	3,6 (8.2)	3,6 (7.9)
	44,0 (145)			
48,0 (160)				

	Boom m (ft)	16,7 (55)	22,8 (75)	28,9 (95)
	Radius			
Luffing jib length 51,8 m (170 ft)	10,0 (36)			
	12,0 (40)			
	14,0 (45)			
	18,0 (60)	11,4 (24.5)	11,4 (24.5)	11,2 (24.7)
	24,0 (80)	7,5 (16.1)	7,5 (16.1)	7,6 (16.3)
	26,0 (90)	6,6 (13.4)	6,6 (13.4)	6,7 (13.7)
	30,0 (100)	5,3 (11.5)	5,3 (11.2)	5,4 (11.5)
	32,0 (110)	4,8 (9.7)	4,7 (9.7)	4,8 (9.9)
	40,0 (130)	3,2 (7.3)	3,2 (7.1)	3,3 (7.3)
	44,0 (145)	2,6 (5.7)	2,6 (5.7)	
48,0 (160)				

For complete chart, refer to [www.cranelibrary.com](http://www.cranelibrary.com).

Meets ANSI B30.5 Requirements - Capacities do not exceed 75% of static tipping load.  
NOTICE: This capacity chart is for reference only and must not be used for lifting purposes.

# Luffing jib load charts

## Model 10000 series 3 liftcrane luffing jib capacities

### No. 10000 luffing jib on luffing boom

28 800 kg (63,500 lb) upper counterweight, 7 300 kg (16,100 lb) carbody counterweight crawler extended

360° Rating

kg (lb) x 1 000

**73° boom angle**

	Boom m (ft)	16,7 (55)	22,8 (75)	28,9 (95)	35,0 (115)
Luffing jib length 15,2 m (50 ft)	Radius				
	14,0 (50)	— (32.2)			
	18,0 (60)	11,7 (25.1)	11,2 (24.3)	— (22.9)	
	20,0 (65)	10,2 (22.7)	9,8 (21.8)	9,4 (20.9)	
	22,0 (70)	— (20.7)	8,6 (19.8)	8,2 (19.0)	7,8 (17.6)
	24,0 (80)			7,3 (15.9)	6,9 (15.0)
	28,0 (95)				
	34,0 (115)				
	38,0 (125)				
	44,0 (145)				
	46,0 (155)				

	Boom m (ft)	16,7 (55)	22,8 (75)	28,9 (95)	35,0 (115)
Luffing jib length 27,4 m (90 ft)	Radius				
	14,0 (50)				
	18,0 (60)				
	20,0 (65)				
	22,0 (70)	8,6 (19.8)			
	24,0 (80)	7,6 (16.3)	7,2 (15.7)		
	28,0 (95)	6,2 (13.0)	5,8 (12.1)	5,4 (11.5)	5,0 (10.6)
	34,0 (115)		4,4 (—)	4,1 (8.6)	3,7 (7.9)
	38,0 (125)				3,1 (6.8)
	44,0 (145)				
	46,0 (155)				

	Boom m (ft)	16,7 (55)	22,8 (75)	28,9 (95)
Luffing jib length 39,6 m (130 ft)	Radius			
	14,0 (50)			
	18,0 (60)			
	20,0 (65)			
	22,0 (70)			
	24,0 (80)			
	28,0 (95)	5,7 (11.9)	— (11.0)	— (7.3)
	34,0 (115)	4,2 (8.8)	3,9 (8.2)	3,6 (5.3)
	38,0 (125)	3,5 (6.8)	3,2 (6.2)	2,9 (4.6)
	44,0 (145)	2,7 (6.0)	2,4 (5.3)	2,1 (4.0)
	50,0 (165)			

	Boom m (ft)	16,7 (55)	22,8 (75)	28,9 (95)
Luffing jib length 51,8 m (170 ft)	Radius			
	14,0 (50)			
	18,0 (60)			
	20,0 (65)			
	22,0 (70)			
	24,0 (80)			
	28,0 (95)	— (7.7)	— (6.8)	— (4.0)
	34,0 (115)	3,7 (5.5)	— (4.9)	— (3.3)
	38,0 (125)	3,0 (4.6)	2,6 (4.0)	2,2 (—)
	44,0 (145)	2,1 (4.0)	1,8 (3.3)	1,5 (—)
	50,0 (165)	1,5 (—)		

For complete chart, refer to [www.cranelibrary.com](http://www.cranelibrary.com).

Meets ANSI B30.5 Requirements - Capacities do not exceed 75% of static tipping load.  
NOTICE: This capacity chart is for reference only and must not be used for lifting purposes.

# Luffing jib load charts

## Model 10000 series 3 liftcrane luffing jib capacities

### No. 10000 luffing jib on luffing boom

28 800 kg (63,500 lb) upper counterweight, 7 300 kg (16,100 lb) carbody counterweight crawler extended

360° Rating

kg (lb) x 1 000

### 63° boom angle

	Boom m (ft)	16,7 (55)	22,8 (75)	28,9 (95)	35,0 (115)		Boom m (ft)	16,7 (55)	22,8 (75)	28,9 (95)	35,0 (115)
	Radius						Radius				
Luffing jib length 15,2 m (50 ft)	14,0 (50)						14,0 (50)				
	18,0 (60)						18,0 (60)				
	20,0 (65)	9,8 (21.6)					20,0 (65)				
	22,0 (70)	8,6 (18.1)	— (16.5)				22,0 (70)				
	24,0 (80)	7,7 (—)	7,1 (14.1)	— (12.8)			24,0 (80)				
	28,0 (95)			5,3 (11.0)	4,6 (9.9)		28,0 (95)	5,7 (12.1)	— (8.2)	— (7.1)	
	34,0 (115)						34,0 (115)	4,3 (9.0)	3,9 (7.1)	3,3 (6.0)	— (4.9)
	38,0 (125)						38,0 (125)		3,2 (—)	2,7 (—)	2,2 (—)
	44,0 (145)						44,0 (145)				1,6 (—)
	46,0 (155)						46,0 (155)				
Luffing jib length 39,6 m (130 ft)	14,0 (50)						Luffing jib length 51,8 m (170 ft)	14,0 (50)			
	18,0 (60)					18,0 (60)					
	20,0 (65)					20,0 (65)					
	22,0 (75)					22,0 (75)					
	26,0 (85)					26,0 (85)					
	28,0 (95)					28,0 (95)					
	38,0 (125)	3,2 (6.8)				38,0 (125)					
	40,0 (135)	2,9 (6.0)	2,4 (4.9)	— (3.7)		40,0 (135)					
	44,0 (145)	2,3 (5.1)	1,9 (4.2)	1,4 (3.1)		44,0 (145)		1,8 (3.7)			
	46,0 (155)	2,1 (4.4)	1,7 (3.5)			46,0 (155)		1,5 (3.1)			
48,0 (160)		1,5 (3.1)			48,0 (160)						

For complete chart, refer to [www.cranelibrary.com](http://www.cranelibrary.com).

Meets ANSI B30.5 Requirements - Capacities do not exceed 75% of static tipping load.  
 NOTICE: This capacity chart is for reference only and must not be used for lifting purposes.



# Clamshell

## Boom:

Welded lattice construction using tubular, high-tensile steel chords with pin connections between sections.

Basic boom length: 12.2 m (40 ft)

Max. boom length: 30.5 m (100 ft)

Limit one clamshell bucket weight: 2 100 kg (4,600 lb)

## Maximum component chart

Boom length m (ft)	Boom arrangement
12.2 (40)	Base-Tip
15.2 (50)	Base-A-Tip
18.3 (60)	Base-A-A-Tip, Base-B-Tip
21.3 (70)	Base-A-B-Tip
24.4 (80)	Base-A-A-B-Tip, Base-B-B-Tip
27.4 (90)	Base-A-C-Tip
30.5 (100)	Base-A-A-C-Tip

Base = 6.10 m (20 ft)

Insert: A = 3.05 m (10 ft)

B = 6.10 m (20 ft)

C = 12.2 m (40 ft)

Tip = 6.10 m (20 ft)

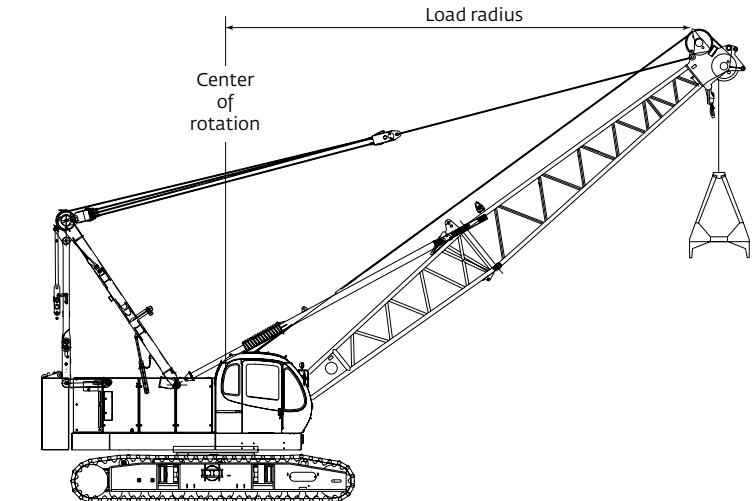

1. Figures represent maximum allowable capacity, and assume level ground and ideal working conditions.
2. Capacities are calculated at 66% of the minimum tipping loads.
3. Capacities are maximum recommended by PCSA Standard #4. Allowances must be made by the user for such unfavorable conditions as a soft or uneven supporting surface, rapid cycle operations, or bucket suction.
4. The combined weight of the bucket and load must not exceed these capacities.
5. Boom length for clamshell operation should not exceed 30.5 m (100 ft).

## Clamshell Capacities

12,1 t (13.3 USt) counterweight  
(one upper counterweight, crawlers extended)

kg (lb) x 1 000

Boom m (ft)	12,2 (40)	15,2 (50)	18,3 (60)	21,3 (70)	24,4 (80)	27,4 (90)	30,5 (100)
Radius							
6,7 (22)	10,0 (22,0)						
7,9 (26)	10,0 (22,0)	10,0 (22,0)					
9,1 (30)	10,0 (22,0)	10,0 (22,0)	10,0 (22,0)				
10,4 (34)	9,7 (21,4)	9,7 (21,4)	9,7 (21,4)	9,7 (21,4)			
12,8 (42)		7,8 (17,3)	7,8 (17,3)	7,8 (17,3)	7,8 (17,3)	7,8 (17,3)	
15,2 (50)			6,6 (14,6)	6,6 (14,6)	6,6 (14,6)	6,6 (14,6)	6,6 (14,6)
17,7 (58)			5,7 (12,5)	5,7 (12,5)	5,7 (12,5)	5,7 (12,5)	5,7 (12,5)
20,1 (66)				5,0 (11,0)	5,0 (11,0)	5,0 (11,0)	5,0 (11,0)
22,6 (74)					4,4 (9,8)	4,3 (9,7)	4,2 (9,4)
25,0 (82)						3,8 (8,3)	3,7 (8,1)
26,8 (88)							3,3 (7,2)
28,7 (94)							3,0 (6,6)

# Manitowoc Crane Care

**Crane Care** is Manitowoc's comprehensive service and support program. It includes classroom and on-site training, prompt parts availability, expert field service, technical support and documentation.

That's commitment you won't find anywhere else.

That's Crane Care.

## Service training

Manitowoc specialists work with you in our training centers and in the field to make sure you know how to get maximum performance, reliability and life from your cranes.

Manitowoc Cranes Technical Training Centers provide valuable multi-level training, which is available for all models and attachments, in the following format:

- **Intro to Canbus and Canbus 1, 2, 3**
- **Intro to EPIC and EPIC 1, 2, 3**
- **Small Crawler 1**
- **Canbus 1 and 2 assembly, operation and maintenance**
- **EPIC 1 and 2 assembly, operation and maintenance**

Refer to [www.manitowoc.com](http://www.manitowoc.com) for course descriptions.

## Parts availability

Genuine Manitowoc replacement parts are accessible through your distributor 24 hours a day, 7 days a week, 365 days a year.

### Service interval kits

**200 hour kit**

**1,000 hour kit**

**2,000 hour kit**

**Hydraulic test kit**

**U.S. standard tools kit**

## Field service

Factory-trained service experts are always ready to help maintain your crane's peak performance.

For a worldwide listing of dealer locations, please consult our website at: [www.manitowoc.com](http://www.manitowoc.com)

## Technical support

Manitowoc's dealer network and factory personnel are available 24 hours a day, 7 days a week, 365 days a year to answer your technical questions and more, with the help of computerized programs that simplify crane selection, lift planning, and ground-bearing calculations.

For a worldwide listing of dealer locations, please consult our website at: [www.manitowoc.com](http://www.manitowoc.com)

## Technical documentation

Manitowoc has the industry's most extensive documentation; available in major languages and formats that include print, videotape, and DVD/CD.

Additional copies available through your Authorized Manitowoc Distributor.

- Crane operator's manual
- Crane parts manual
- Crane capacity manual
- Crane vendor manual
- Crane service manual
- Luffing jib operator's/parts manual
- Capacity chart manual - attachments

CD rom versions of the operator's and parts manuals are shipped with each crane. Also available are the following CDs:

- Crane Care Owner CD –
- Ground Bearing Pressure Estimator CD
- Crane Selection and Planning Software (CompuCRANE®)
- EPIC® Crane Library CD consisting of capacity charts, range diagrams, wire rope specifications, travel specifications, crane weights, counterweight arrangements, luffing jib raising procedures, operating range diagrams, drum and lagging charts, boom rigging drawings, jib rigging drawings, outline dimensions and wind condition charts.

Available from your Authorized Manitowoc Cranes Distributor, these videos are available in NTSC, PAL, SECAM, and DVD formats.

- Your Capacity Chart Video
- Respect the Limits Video
- Crane Safety Video
- Boom Inspection/Repair Video

### Crane Care Package

Manitowoc has assembled all of the available literature, CD's and videos listed above plus several Manitowoc premiums into one complete Crane Care Package.



## Manitowoc Cranes

### Regional headquarters

#### Americas

**Manitowoc, Wisconsin, USA**

Tel: +1 920 684 6621

Fax: +1 920 683 6277

**Shady Grove, Pennsylvania, USA**

Tel: +1 717 597 8121

Fax: +1 717 597 4062

#### Europe, Middle East, Africa

**Ecully, France**

Tel: +33 (0)4 72 18 20 20

Fax: +33 (0)4 72 18 20 00

#### China

**Shanghai, China**

Tel: +86 21 6457 0066

Fax: +86 21 6457 4955

#### Greater Asia-Pacific

**Singapore**

Tel: +65 6264 1188

Fax: +65 6862 4040

### Regional offices

#### Americas

##### Brazil

Alphaville

##### Mexico

Monterrey

##### Chile

Santiago

#### Europe, Middle East,

##### Africa

##### Czech Republic

Netvorice

##### France

Baudemont

Cergy

Decines

##### Germany

Langenfeld

##### Hungary

Budapest

##### Italy

Lainate

##### Netherlands

Breda

##### Poland

Warsaw

##### Portugal

Baltar

##### Russia

Moscow

##### U.A.E.

Dubai

##### U.K.

Buckingham

#### China

Beijing

Chengdu

Guangzhou

Xian

#### Greater Asia-Pacific

##### Australia

Adelaide

Brisbane

Melbourne

Sydney

##### India

Calcutta

Chennai

Delhi

Hyderabad

Pune

##### Korea

Seoul

##### Philippines

Makati City

##### Singapore

### Factories

#### Brazil

Alphaville

#### China

TaiAn

Zhangjiagang

#### France

Charlieu

La Clayette

Moulines

#### Germany

Wilhelmshaven

#### India

Pune

#### Italy

Niella Tanaro

#### Portugal

Baltar

Fânzeres

#### Slovakia

Saris

#### USA

Manitowoc

Port Washington

Shady Grove

This document is non-contractual. Constant improvement and engineering progress make it necessary that we reserve the right to make specification, equipment, and price changes without notice. Illustrations shown may include optional equipment and accessories and may not include all standard equipment.