

Worldwide offices

International

TADANO LTD.

International Division
4-12, Kamezawa 2-chome
Sumida-Ku, Tokyo 130-0014, Japan
Phone: +81-3-3621-7750
Fax: +81-3-3621-7785
E-mail: tdnihq@tadano.co.jp

TADANO AMERICA CORPORATION

4242 West Greens Road
Houston, TX 77066, USA
Phone: +1-281-869-0030
Fax: +1-281-869-0040
E-mail: sales@tadano-cranes.com

TADANO LTD. Middle East Representative Office

P.O.Box 18302, LOB15-323
Jebel Ali Free Zone, Dubai, UAE
Phone: +971-4-887-1353
Fax: +971-4-887-1703
E-mail: tadano@tadano.ae

TADANO LTD. Beijing Office

Jing Guang Centre, Room 2905, Hu Jia Lou
Chao Yang Qu
Beijing, China
Phone: +86-10-6597-3210
Fax: +86-10-6597-3220
E-mail: beijing@tadano.co.jp

Europe

TADANO FAUN GmbH

Faunberg 2
91207 Lauf a. d. Pegnitz
Germany
Phone: +49-9123-955-0
Fax: +49-9123-3085
E-mail: info@tadanofaun.de

TADANO SOUTH CHINA CO. LTD.

Room 1803, 18/F Seaview Commercial
Building 21-24 Connaught Road West
Hong Kong, China
Phone: +852-2544-9310
Fax: +852-2541-5828
E-mail: hiwa@tadanosc.com

TADANO Korea Co Ltd.

302, Koram Venture Town B/D
907-1 Daechi-Dong, Gangnam-Ku
Seoul 135-280, Korea
Phone: +82-2-714-1600
Fax: +82-2-3274-1304
E-mail: tadano@korea.com

TADANO Asia Pte Ltd.

11 Tuas View Crescent
Multico Building
Singapore 637643
Phone: +65-6863-6901
Fax: +65-6863-6902
E-mail: Tdn-crane@tadanoasia.com

TAIWAN TADANO LTD.

4F, No.50, Sung Chiang Road
Taipei
Taiwan
Phone: +886-2-2523-1388
Fax: +886-2-2523-3988
E-mail: tadano@ms18.hinet.net

TADANO FAUN HOLLAND B.V.

Antennestraat 6
3903 LZ Veenendaal
The Netherlands
Phone: +31-318-546-700
Fax: +31-318-542-282
E-mail: info@tadano-faun.nl

Detaillierte Informationen über unsere Internationalen Händler und Service Niederlassungen finden Sie im Internet.
For detailed information about our International Distributor and Service network, please refer to our homepages.

www.tadano.co.jp + www.tadanofaun.de + www.tadanoamerica.com

Herausgeber / Publisher:

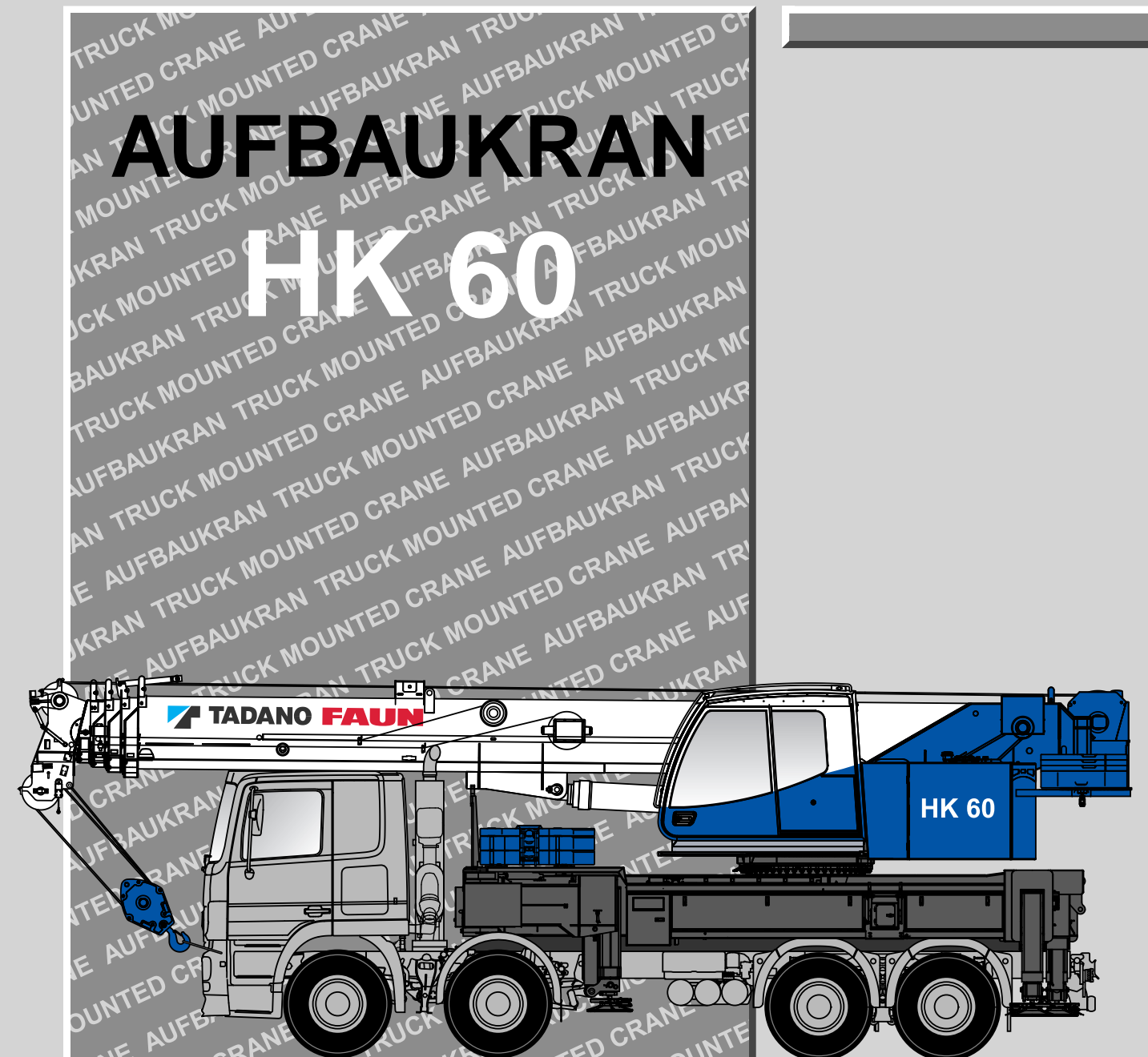

TADANO FAUN GmbH
P.O.Box 10 02 64
91205 Lauf
Germany

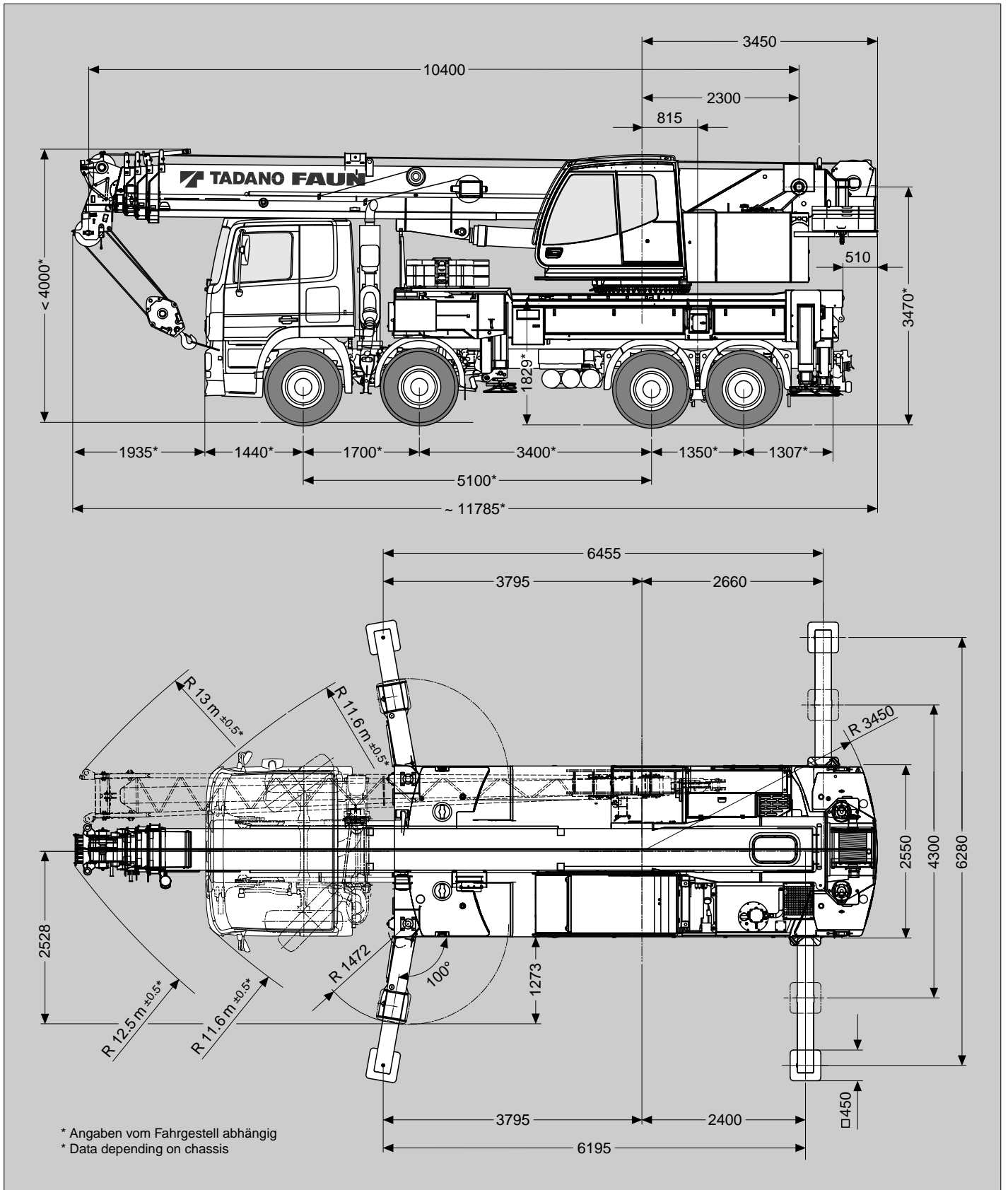

Maße (mm)
Dimensions (mm)

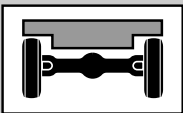

Gewichte / Geschwindigkeiten Weights / Working speeds

	Achse / Axle	1	2	3	4	Gesamtgewicht / Total weight
	4 -  (t)	≤ 9*	≤ 9*	≤ 12*	≤ 12*	≤ 42*

* Abhängig vom Fahrgestell und Optionen, incl. 8,4 t Gegengewicht, 12,5 t Unterflasche, 6 t Hakengeschirr.





* Abhängig vom Fahrgestell und Optionen, incl. 7,3 t Gegengewicht, 9 m / 16 m Auslegerverlängerung, 12,5 t Unterflasche, 6 t Hakengeschirr.

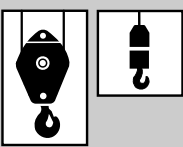





* Depending on chassis and options, incl. 8.4 t counterweight, 12.5 t hook block, 6 t swivel hook.

* Depending on chassis and options, incl. 7.3 t counterweight, 9 m / 16 m boom extension 12.5 t hook block, 6 t swivel hook.

	Traglast / Lifting capacity	Rollen / Sheaves	Stränge / Parts of line	Gewicht / Weight
	32 t	3	7	300 kg
	12.5 t	1	3	180 kg
	6 t	-	1	150 kg

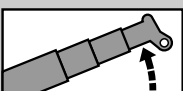

								
km/h 	Alle diese Daten abhängig vom Fahrgestell This data depending on chassis							
km/h 								
								

V+ 	Stufenlos Infinitely variable	Seil Rope	Max. Seilzug Max. single line pull
	0 - 130 m/min für einfachen Strang single line	16 mm / 170 m	44 kN
	0 - 130 m/min für einfachen Strang single line	16 mm / 170 m	44 kN
	0 - 2 min ⁻¹		
	-2° - +82° ca. 33 s approx. 33 s		
	10.4 m - 40.2 m ca. 90 s approx. 90 s		

Tragfähigkeiten Lifting capacities

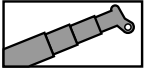

8.4 t

DIN/ISO/EN

 m	10.4 m*	10.4 m	14.1 m	17.8 m	25.3 m	32.7 m	36.5 m	40.2 m
2.5	60.0**	50.0						
3.0	49.1	44.5	30.0					
3.5	45.1	40.4	30.0	30.0				
4.0	41.6	37.0	30.0	29.0				
4.5	38.6	34.0	30.0	27.6				
5.0	35.8	31.5	30.0	26.2	17.0			
6.0	30.3	27.3	26.7	22.6	17.0	13.0		
7.0	23.6	23.6	22.6	20.0	15.8	13.0		
8.0	16.8	16.8	17.8	18.3	14.5	13.0	9.0	7.0
9.0			14.5	14.9	13.3	12.0	8.8	7.0
10.0			12.1	13.0	13.0	11.0	8.5	7.0
11.0			10.2	11.8	11.4	10.1	8.3	7.0
12.0				10.3	10.1	9.2	8.1	7.0
14.0				8.0	8.3	7.1	7.3	6.5
16.0					6.6	5.8	5.7	5.9
18.0					5.3	5.1	4.5	4.7
20.0					4.3	4.5	3.5	3.7
22.0					3.5	3.7	2.7	2.9
24.0						3.0	2.1	2.3
26.0							2.5	1.8
28.0							2.1	1.4
30.0							1.7	1.0
32.0							0.5	0.7

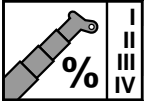

I	0	0	50	50/100/0	50/100/0	100/0	100	100
II	0	0	0	50/0/33	50/100/66	100/100	100	100
III	0	0	0	0/0/33	50/0/66	50/100	75	100
IV	0	0	0	0/0/33	50/0/66	50/100	75	100

* Nach hinten / * Over rear

** Mit Zusatzhubausrüstung / ** With additional lifting equipment

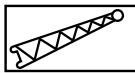
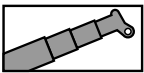

8.4 t

DIN/ISO/EN

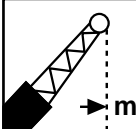
 m	36.5 m + 9.0 m			40.2 m + 9.0 m			40.2 m + 16.0 m		
	5°	20°	40°	5°	20°	40°	5°	20°	40°
10	4.8			3.8					
11	4.8			3.8					
12	4.8	3.8		3.8	3.4		2.2		
14	4.6	3.6	2.5	3.8	3.4	2.5	2.2		
16	4.3	3.3	2.4	3.7	3.3	2.5	2.2	1.8	
18	4.1	3.1	2.3	3.6	3.1	2.4	2.1	1.7	1.3
20	3.6	2.9	2.2	3.4	3.0	2.3	2.1	1.7	1.3
22	2.9	2.8	2.1	2.9	2.9	2.2	2.0	1.6	1.2
24	2.2	2.5	2.1	2.3	2.6	2.1	1.9	1.5	1.2
26	1.7	1.9	2.0	1.8	2.0	2.1	1.8	1.5	1.2
28	1.3	1.4	1.6	1.4	1.5	1.7	1.7	1.4	1.1
30	0.9	1.0	1.2	1.0	1.1	1.3	1.5	1.3	1.1
32	0.6	0.7	0.8	0.7	0.8	0.9	1.2	1.2	1.1
34					0.5	0.6	0.9	1.1	1.0
36							0.6	0.8	1.0
38								0.6	0.7
40									0.5

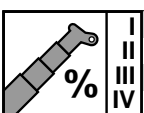

I	100			100			100		
II	100			100			100		
III	75			100			100		
IV	75			100			100		

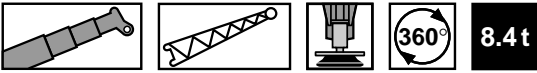

DIN/ISO/EN

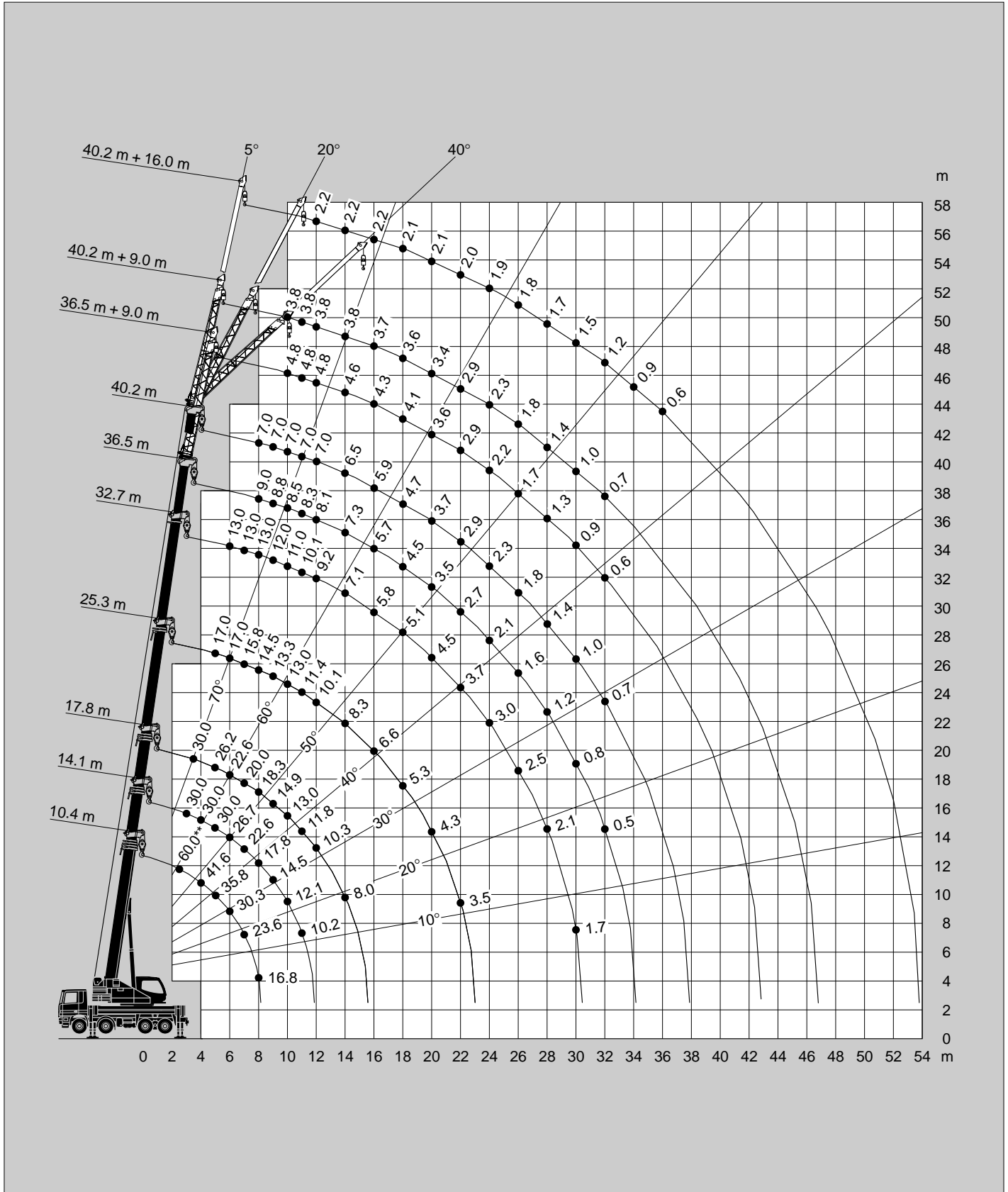

Tragfähigkeiten Lifting capacities

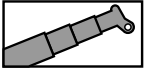

7.3t

DIN/ISO/EN

 m	10.4 m*	10.4 m	14.1 m	17.8 m	25.3 m	32.7 m	36.5 m	40.2 m
2.5	60.0**	50.0						
3.0	49.1	44.5	30.0					
3.5	45.1	40.4	30.0	30.0				
4.0	41.6	37.0	30.0	29.0				
4.5	38.6	34.0	30.0	27.6				
5.0	35.8	31.5	30.0	26.2	17.0			
6.0	29.9	27.3	26.7	22.6	17.0	13.0		
7.0	22.6	22.6	21.6	20.0	15.8	13.0		
8.0	16.8	16.8	17.0	17.4	14.5	13.0	9.0	7.0
9.0			13.8	14.2	13.3	12.0	8.8	7.0
10.0			11.4	13.0	12.7	11.0	8.5	7.0
11.0			9.6	11.2	10.8	9.8	8.3	7.0
12.0				9.8	10.1	8.6	8.1	7.0
14.0				7.5	7.9	6.7	6.8	6.5
16.0					6.2	5.8	5.3	5.4
18.0					4.9	5.1	4.1	4.3
20.0					4.0	4.1	3.1	3.4
22.0					3.2	3.3	2.4	2.6
24.0						2.7	1.8	2.0
26.0						2.2	1.3	1.5
28.0						1.8	0.9	1.1
30.0						1.5	0.6	0.8
32.0								0.5

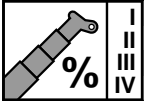

I	0	0	50	50/100/0	50/100/0	100/0	100	100
II	0	0	0	50/0/33	50/100/66	100/100	100	100
III	0	0	0	0/0/33	50/0/66	50/100	75	100
IV	0	0	0	0/0/33	50/0/66	50/100	75	100

* Nach hinten / * Over rear

** Mit Zusatzhubausrüstung / ** With additional lifting equipment

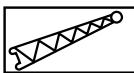
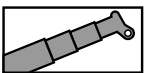

7.3t

DIN/ISO/EN

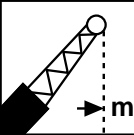
 m	36.5 m + 9.0 m			40.2 m + 9.0 m			40.2 m + 16.0 m		
	5°	20°	40°	5°	20°	40°	5°	20°	40°
10	4.8			3.8					
11	4.8			3.8					
12	4.8	3.8		3.8	3.4		2.2		
14	4.6	3.6	2.5	3.8	3.4	2.5	2.2		
16	4.3	3.3	2.4	3.7	3.3	2.5	2.2	1.8	
18	4.0	3.1	2.3	3.6	3.1	2.4	2.1	1.7	1.3
20	3.2	2.9	2.2	3.2	3.0	2.3	2.1	1.7	1.3
22	2.5	2.8	2.1	2.5	2.9	2.2	2.0	1.6	1.2
24	2.0	2.2	2.1	2.0	2.3	2.1	1.9	1.5	1.2
26	1.5	1.7	1.8	1.5	1.8	2.0	1.8	1.5	1.2
28	1.0	1.2	1.4	1.1	1.3	1.5	1.6	1.4	1.1
30	0.7	0.8	0.9	0.8	0.9	1.1	1.3	1.3	1.1
32		0.5	0.6	0.5	0.6	0.7	1.0	1.2	1.1
34							0.7	0.9	1.0
36							0.5	0.7	0.9
38									0.6

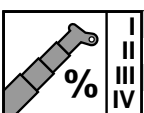

I	100			100			100		
II	100			100			100		
III	75			100			100		
IV	75			100			100		

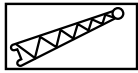
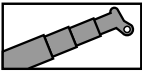

7.3t

DIN/ISO/EN

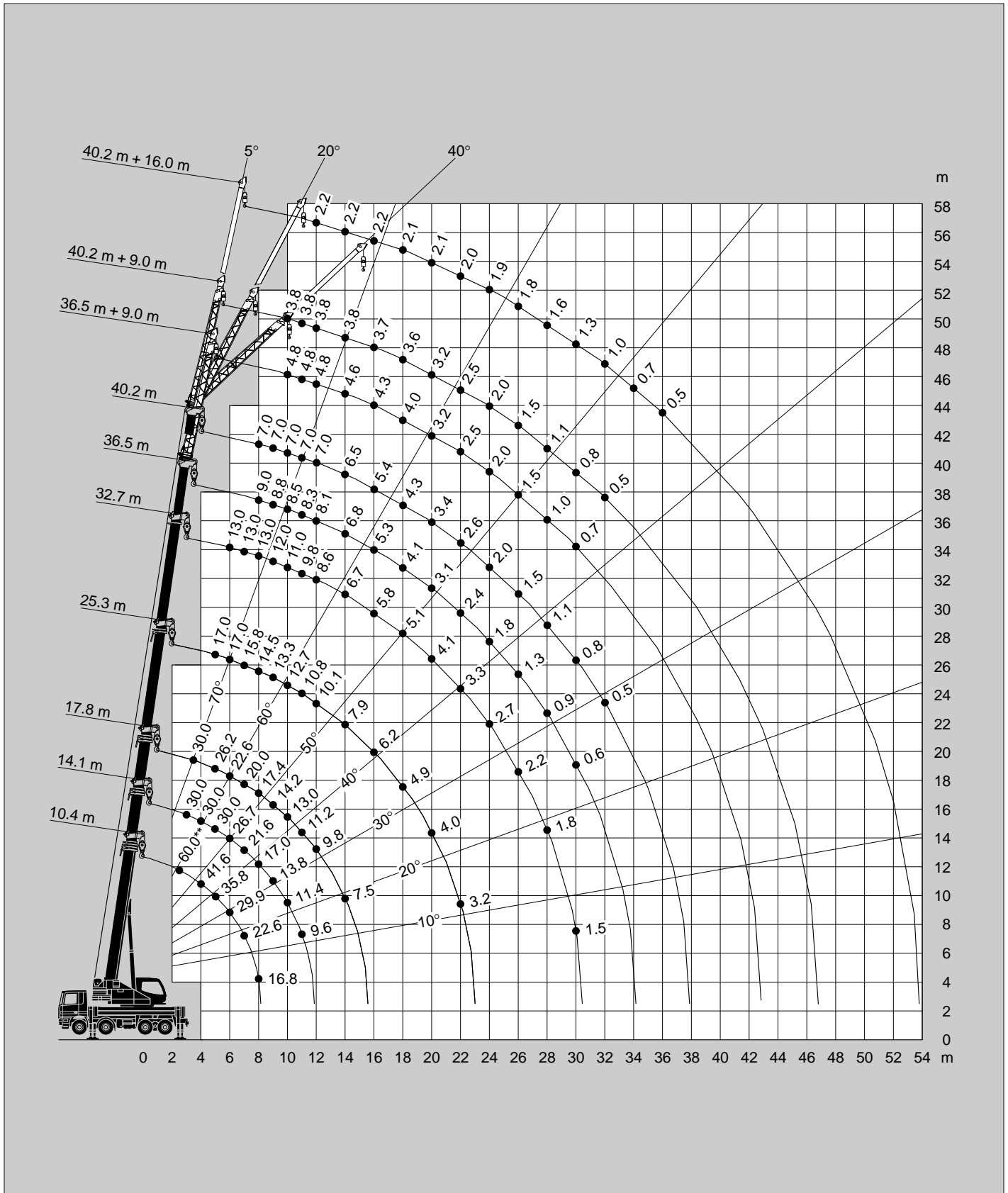

Tragfähigkeiten Lifting capacities

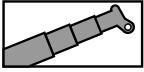

3.1 t

DIN/ISO/EN

 m	10.4 m	14.1 m	17.8 m	25.3 m	32.7 m	36.5 m	40.2 m
2.5	47.5						
3.0	42.8	30.0					
3.5	38.8	30.0	30.0				
4.0	35.5	30.0	29.0				
4.5	32.7	30.0	27.6				
5.0	30.2	29.7	26.2	17.0			
6.0	24.9	23.8	21.0	17.0	13.0		
7.0	18.7	17.7	17.8	15.5	13.0		
8.0	14.7	13.8	14.2	13.0	11.8	9.0	7.0
9.0		11.0	12.9	11.5	9.7	8.8	7.0
10.0		8.6	10.6	10.6	8.1	8.1	7.0
11.0		6.9	8.8	9.1	7.8	6.9	6.9
12.0			7.4	7.8	7.4	5.9	6.0
14.0			5.4	5.7	5.8	4.4	4.5
16.0				4.3	4.5	3.3	3.5
18.0				3.3	3.4	2.4	2.6
20.0				2.5	2.7	1.7	1.9
22.0				2.0	2.1	1.1	1.3
24.0					1.6	0.7	0.9
26.0					1.2		0.5
28.0					0.9		
30.0					0.6		

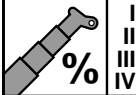
 %	I	II	III	IV	I	II	III	IV	I	II	III	IV	
0	0	50	50/100/0	50/100/0	100/0	100	100	100	0	0	50	50/100/0	50/100/0
0	0	0	50/0/33	50/100/66	100/100	100	100	100	0	0	0	0/0/33	50/0/66
0	0	0	0/0/33	50/0/66	50/100	75	100	100	0	0	0	0/0/33	50/0/66
0	0	0	0/0/33	50/0/66	50/100	75	100	100	0	0	0	0/0/33	50/0/66

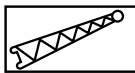
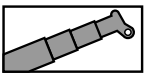

3.1 t

DIN/ISO/EN

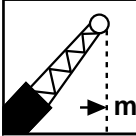
 m	36.5 m + 9.0 m			40.2 m + 9.0 m			40.2 m + 16.0 m		
	5°	20°	40°	5°	20°	40°	5°	20°	40°
10	4.8			3.8					
11	4.8			3.8					
12	4.8	3.8		3.8	3.4		2.2		
14	4.3	3.6	2.5	3.8	3.4	2.5	2.2		
16	3.2	3.3	2.4	3.2	3.3	2.5	2.2	1.8	
18	2.4	2.9	2.3	2.4	2.9	2.4	2.1	1.7	1.3
20	1.8	2.2	2.2	1.8	2.2	2.3	2.1	1.7	1.3
22	1.2	1.6	1.9	1.3	1.6	2.0	1.7	1.6	1.2
24	0.8	1.1	1.4	0.8	1.2	1.5	1.3	1.5	1.2
26		0.7	0.9	0.5	0.7	1.0	0.9	1.4	1.2
28			0.5			0.6	0.6	1.1	1.1
30								0.8	1.1
32								0.5	0.7

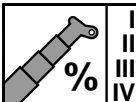
 %	I	II	III	IV	I	II	III	IV	I	II	III	IV
100	100	100	100	100	100	100	100	100	100	100	100	100
100	100	100	100	100	100	100	100	100	100	100	100	100
75	75	75	75	75	75	75	75	75	75	75	75	75
75	75	75	75	75	75	75	75	75	75	75	75	75

Hubhöhen
Lifting heights

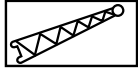
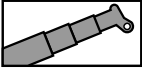

3.1 t

DIN/ISO/EN

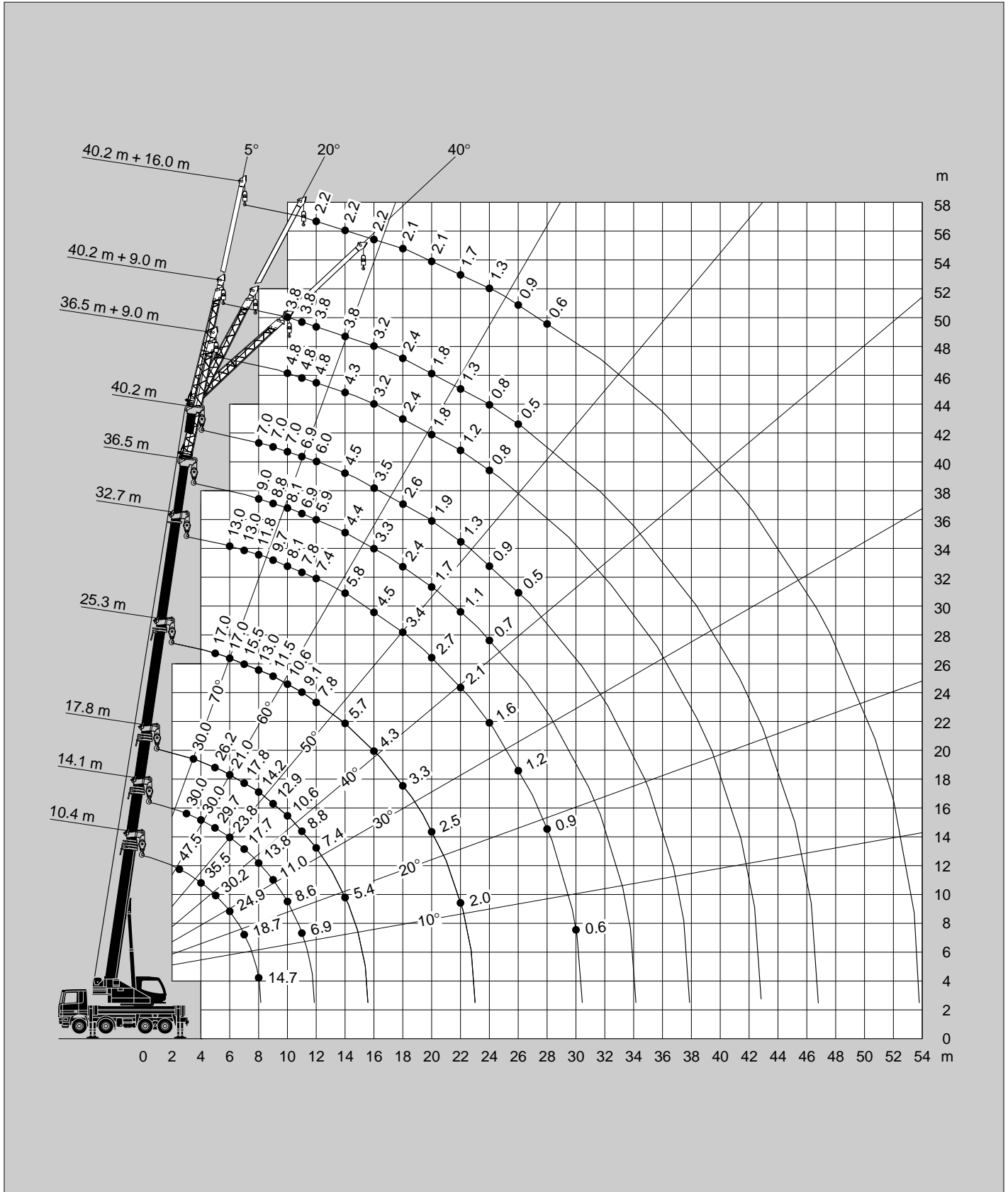

Gegengewichtvarianten Counterweight versions

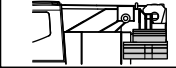
	Gegengewicht / Counterweight	6x	2x	1x	1x	2x	2x
		(t)	①	②	③	④	⑤
		0.17	0.5	1.1	1.1	0.27	1.83

8.4t

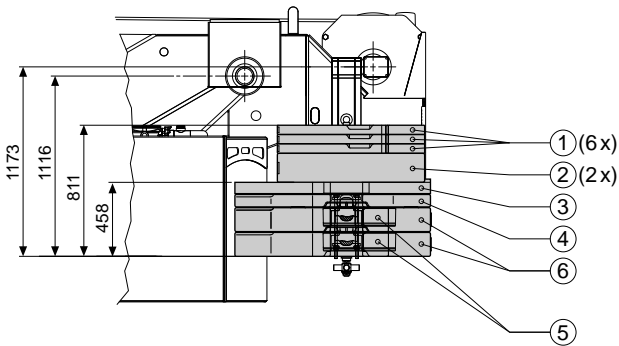

7.3t

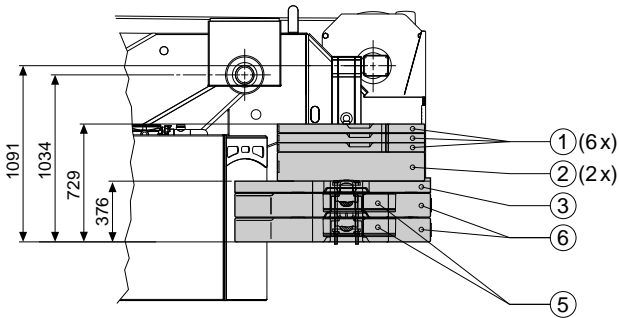

3.1t

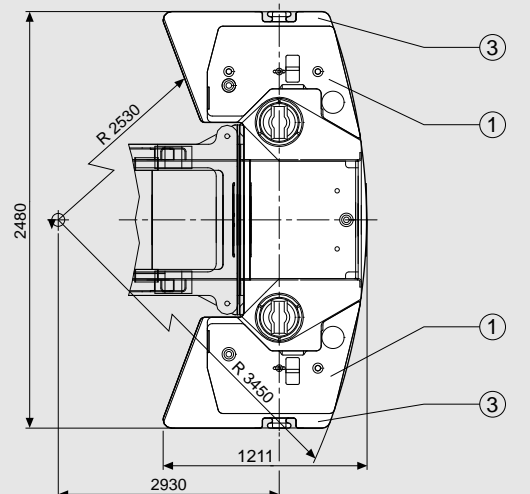
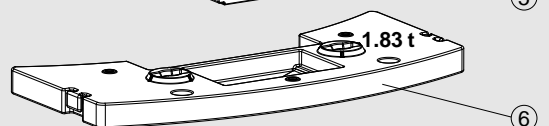
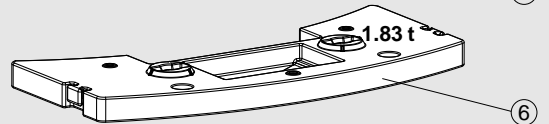
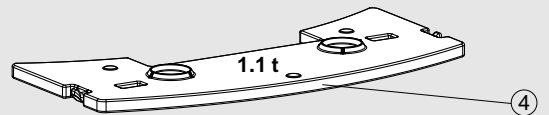
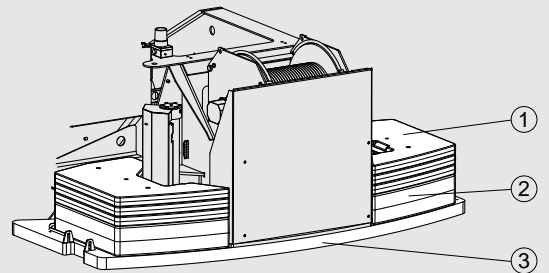
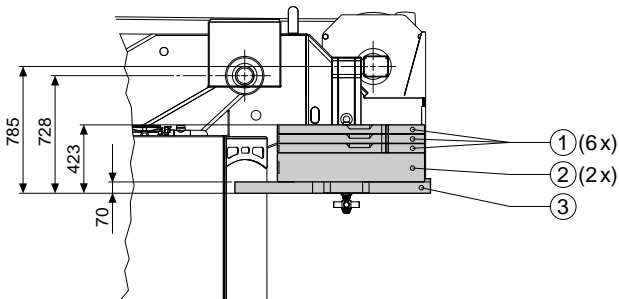

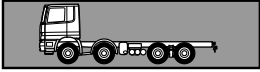

Fahrgestell 4-achsiges handelsübliches MAN oder Mercedes-Benz-Fahrgestell (8 x 4).
Andere Fahrgestelle auf Anfrage.

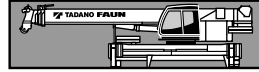

Hauptrahmen Verwindungs- und biegesteife Stahlkonstruktion aus hochfestem Feinkornstahl in Kastenbauweise zur Befestigung am Trägerfahrzeug.

Abstützung Hydraulische, teleskopierbare 4-Punkt-Abstützung vorne schwenkbar, Bedienungsmöglichkeiten an beiden Seiten des Fahrgestelles.
Abstützbasis 6,28 m x 6,32 m und 4,3 m x 6,17.

Oberwagenrahmen Verwindungssteife Schweißkonstruktion mit einer außenverzahnten, einreihigen Kugeldrehverbindung, um 360° unbegrenzt drehbar.

Motor Mercedes-Benz 4-Zylinder-Dieselmotor OM 904 LA (Euromot III A / EPA III), wassergekühlt. Drehzahl über Fußpedal stufenlos regelbar, Leistung 90 kW (122 PS) bei 2200 min⁻¹. Drehmoment 470 Nm (48 kpm) bei 1200 min⁻¹. Motorleistung nach DIN 6270B / DIN 6271. Kraftstoffbehälter 200 l.

Hydraulik System Diesel-hydraulisch mit 3-Kreishydraulik, 1 leistungsgeregelte Axialkolbendoppelpumpe (hydraulisch verstellbar) und 1 Zahnrad-Doppelpumpe.

Steuerung Zwei 4-fach Kreuzsteuerhebel mit hydraulischer Vorsteuerung für gleichzeitige, voneinander unabhängige Kranbewegungen.

Teleskopausleger Fünfteiliger Teleskopausleger aus hochfestem Feinkornstahl, bestehend aus einem Grundausleger und 4 Teleskopteilen, hydraulisch unter Teillast teleskopierbar.
10,4 m - 40,2 m lang.

Wippwerk Differentialzylinder mit angebautelem Senkbremssperrventil.

Hubwerk Axialkolben-Motor, Hubwerkstrommel mit eingebautem Planetengetriebe und federbelasteter Hydro-Lamellenbremse mit integriertem Freilauf beim Heben. Hubseil mit 'Super-Stop' Einrichtung.

Drehwerk Axialkolben-Motor, zweistufiges Planetengetriebe mit fußbetätigter Betriebsbremse und Feststellung. Drehgeschwindigkeit stufenlos von 0 - 2 min⁻¹.

Gegengewicht Standard 8,4 t teilbar.
Die Bedienung erfolgt aus der Oberwagenkabine.

Oberwagenkabine Großräumige Krankabine in Stahl-Kunststoff-Ausführung mit Sicherheitsverglasung mit getönten Scheiben, kippbarem Arbeitsplatz mit verstellbarem, hydraulisch gedämpftem Fahrersitz, motorunabhängige Warmwasserheizung, Kontroll- und Bedienungselemente für Kranbetrieb.

Elektrische Anlage 24 V Gleichstrom, 2 Batterien.

Sicherheitseinrichtungen Lastmomentbegrenzung (LMB), Hubendechalter, Windenendschalter, Seilwindendrehmelder, Sicherheitsventile gegen Rohr- und Schlauchbrüche. Sperrventile an Hydraulik-Zylindern.

Zusatzausrüstung (gegen Mehrpreis)
Auslegerverlängerung 9 m / 16 m, abwinkelbar 5°, 20° und 40°, 6 t Hakengeschirr, verschiedene Unterflaschen, 2. Hubwerk, motorunabhängige Zusatzheizung, Klimaanlage, Sonderlackierung und Beschriftung.

Weitere Zusatzausrüstung auf Anfrage.

Anmerkungen zu den Traglasttabellen

Die Tragfähigkeiten im Festigkeitsbereich basieren auf DIN 15018 Teil 3 / F.E.M. / EN 13000.

Die Tragfähigkeiten im Standsicherheitsbereich entsprechen DIN 15019 Teil 2 / ISO 4305 / EN 13000.

Die zulässige Windgeschwindigkeit beträgt maximal 15 m/sec.

Die Tragfähigkeiten sind in metrischen Tonnen angegeben.

Das Gewicht des Lasthakens bzw. der Hakenflasche und weiterer Anschlagmittel ist von der Tragfähigkeit abzuziehen.

Die Tragfähigkeiten für den Teleskopausleger gelten nur bei demontierter Spitze.

Die Ausladung ist der horizontale Abstand von Mitte Drehkranz bis Mitte freihängender, nicht schwingender Last.

Tragfähigkeitsänderungen vorbehalten.

Obige Angaben dienen nur zur Information.
Die Bedienungsanleitungen müssen zu Rate gezogen werden, bevor die Maschine in Betrieb genommen wird. Alle hier gemachten Angaben beziehen sich auf die Standard-Ausführung.
Jegliche Ausrüstungsveränderungen können die angegebenen Werte beeinflussen.

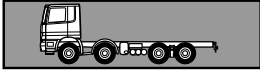

Chassis 4 axle MAN or Mercedes-Benz chassis (8 x 4).
Other chassis on request.

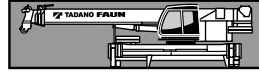

Main frame Torsion-resistant, steel construction made from high strength, fine-grained steel. Specially designed for the type of chassis selected.

Outriggers Hydraulically extendable 4 point outriggers front slewable with controls on both sides of carrier.
Outrigger base 6,28 m x 6,32 m und 4,3 m x 6,17.

Frame Torsion-resistant all-welded structure with a single-row ball slewing ring with external gearing for 360° continuous rotation.

Superstructure engine Mercedes-Benz 4 cylinder model OM 904 LA (Euromot III A/EPA III), water cooled, diesel engine. Engine speed infinitely controlled via pedal. Rated at 90 kW (122 HP) at 2200 min⁻¹. Torque 470 Nm (48 kpm) at 1200 min⁻¹. Engine rating according to DIN 6270B/DIN 6271. Fuel tank 200 l.

Hydraulic system Three circuit diesel hydraulic system with 1 power controlled axial piston double pump (hydraulically adjustable) and 1 double gear pump.

Controls Hydraulic, 2 joy-stick levers for simultaneous and independent operation of 4 crane motions.

Telescopic boom 5 sections, made of high tensile, fine-grained steel, consisting of 1 base section and 4 telescoping sections. All telescope sections extendable under partial load. 10.4 m to 40.2 m long.

Derricking system 1 differential hydraulic cylinder with integral brake and holding valve.

Main winch Axial piston motor, winch drum with integrated planetary reduction and with hydraulically controlled spring-loaded, multiple disc brake and with integrated free rotation (no sagging of load when hoisting).
Hoist cable with 'Super-Stop' easy reeving system.

Slewing system Axial piston motor with two-stage planetary reduction with a foot actuated service and a parking brake. Speed infinitely variable 0 - 2 min⁻¹.

Counterweight Standard 8.4 t divisible, assembled and disassembled by hydraulic cylinders controlled from superstructure cab.

Superstructure cab Spacious panoramic cab of composite structure with safety (tinted) glass windows, tiltable cockpit with hydraulically cushioned adjustable seat, engine independent hot-water heater. Complete controls and instrumentation for crane operation.

Electrical system 24 volt DC system, 2 batteries.

Safety devices Load moment device (LMD), hoist limit switch, lower limit switch, drum turn indicator, safety valves against pipe and hose rupture. Holding valves on hydraulic cylinders.

Optional Equipment (at extra charge)
Boom extension 9 m / 16 m long, offsets 5°, 20° and 40°, 6 t swivel hook, selection of hook blocks, auxiliary winch, engine independent additional heater, air conditioning, special painting and lettering.

Further optional equipment available upon request.

Remarks concerning the load charts

The lifting capacities in the structural area are based on DIN 15018 part 3/FE.M./EN 13000.

The lifting capacities in the stability area are based on DIN 15019 part 2/ISO 4305/EN 13000.

The maximum permissible wind speed for crane operation is 15 m/sec.

The lifting capacities shown are in metric tons.











The weight of load handling devices such as hook blocks, slings, etc., must be considered as part of the load and must be deducted from the lifting capacities.

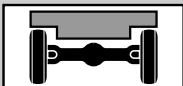





The lifting capacities for the telescopic boom apply to a crane with no boom extensions being stowed or mounted on the crane.

The working radius is the horizontal distance from the centre of rotation to the centre of the freely suspended non-oscillating load.

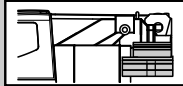
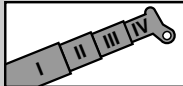
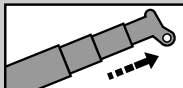
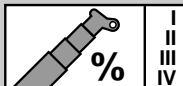
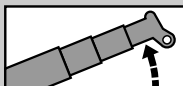
The lifting capacities are subject to change without prior notice.

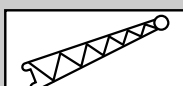
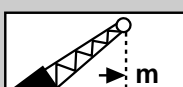
The above remarks are for basic information only and the operator's manual must be consulted before operating this crane. All data and performances refer to the standard crane. The addition of optional and other equipment may affect the performance of the crane.

	Siehe Seite 11 As on Page 12
	Abstützung Outriggers
	Getriebe / Gang Transmission / Gear
	Achslast Axle load
	Räder / Größe Tyres / Size
	Gelände Off road
	Straße On road
	Geschwindigkeiten Speeds
	Steigfähigkeit Gradeability
	Drehwerk Slewing system
	Gegengewicht Counterweight

	Gegengewichtvarianten Counterweight versions Variations des contrepoids Variaciones de contrapeso
	Teleskopausleger Telescopic boom
	Teleskopieren Boom telescoping
	Teleskopieren in % Boom telescoping in %
	Wippwerk Derricking system
	Ausladung Radius
	Auslegerverlängerung Boom extension
	Ausladung Radius
	Hubwerk Main winch
	2. Hubwerk Auxiliary winch
	Unterflasche / Hakengeschirr Hook block / Swivel hook