

PK 11001 CM

High Performance

PALFINGER CRANE

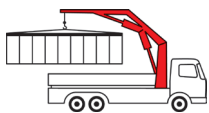

The all-round crane for municipal use

The PK 11001 CM (Corner Mount) was designed especially for service-body vehicles, allowing for maximum utilization of body compartment space and rear-bumper access to the bed. Fitted with the appropriate auxiliary equipment, the crane rapidly becomes a multi-functional workhorse.

Reliable and efficient

PALFINGER USA Inc.
 4151 West State Route 18
 Tiffin, OH 44883
 U.S.A.
 Tel. 419-937-2190

PALFINGER Inc.
 7942 Dorchester Rd.
 Niagara Falls, ON L2E 6V6
 Canada
 Tel. 905-374-3363
 Fax 905-374-1203
 Toll Free 800-567-1554
 www.palfinger-northamerica.com

11001 CM
 09.09

PK 11001 CM High Performance

A

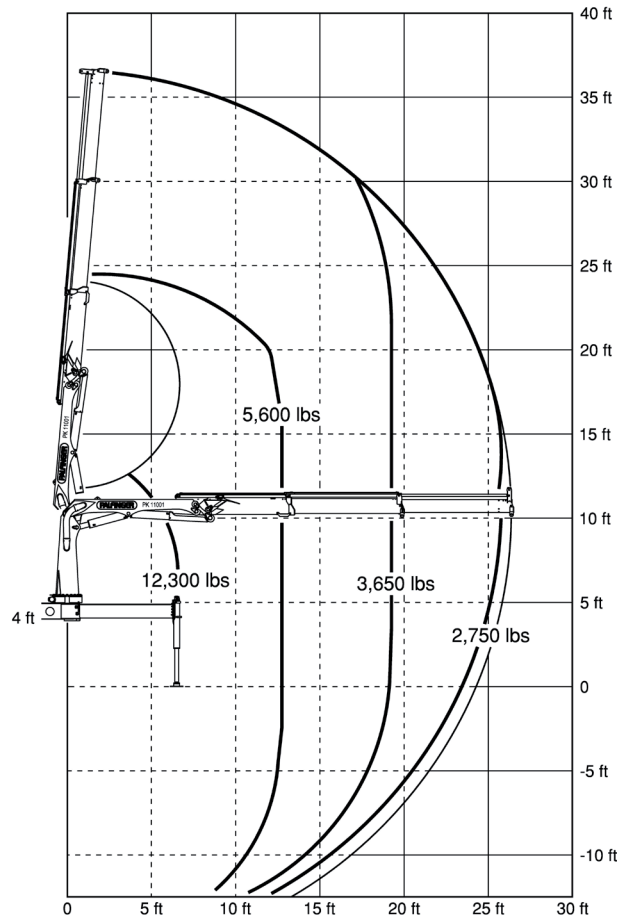

Technical Specifications

Max. lifting moment	74,550 ft.lbs
Max. lifting capacity	12,300 lbs
Max. hydraulic outreach	26'5"
Slewing angle	390°
Slewing torque (net)	9,400 ft.lbs
Stabilizer spread	13'0"
Max. operating pressure	4,640 psi
Recommended pump capacity	11.9 US gal./min
	15.9 US gal./min
Dead weight (std.)	2,770 lbs

