

SPECIFICATIONS TABLE

Crane Model	UR-W376CDRS	UR-W375CDRS
Capacity	2,930 Kg at 2.5 m	2,930 Kg at 2.5 m
Working Radius	0.62 m to 14.45 m	0.62 m to 12.14 m
Hook Height above ground level (Approx)	Max. 14.9 m	Max. 12.6 m
Hook Height below ground level (Approx)	Max. 18.7 m	Max. 15.6 m
Boom Length	Min. 3.63 m to Max. 14.61 m	Min. 3.54 m to Max. 12.30 m
Boom Extending Speed	10.98 m / 23.0 sec	8.76 m / 20.0 sec
Boom Section	6 Section	5 Section
Wire Rope	Construction : IWRC 6 × WS (26) B type / Diameter and Length : 8.0 mm × 85.0 m / Breaking Strength : 4,320 kg	Construction : IWRC 6 × WS (26) B type / Diameter and Length : 8.0 mm × 73.5 m / Breaking Strength : 4,320 kg
Boom Structure	6 Sided (Hexagonal) Box Beam with Angle Indicator and Anti-Two-Block Boom is Full Hydraulic Powered	
Boom Telescopic Cylinder	Double Acting type with Counterbalance Valve	
Boom Raising Angle / Speed	0° to 80° / 10.0 sec	
Boom Raising Cylinder	Double Acting type with Counterbalance Valve	
Winch	Oversized Drum for extra long cables and hoists. Winch Hook Designed to match the crane capacity. Can be used with Nylon Slings. Hydraulic Axial Plunger Type Motor, Spur Gear Reduction, with Automatic Brake.	
Winch Speed (Single Line)	68.0 m / min at 4th Layer	
Hook Speed (4 part Line)	17.0 m / min at 4th Layer	
Hook Block	2,930 kg Capacity with 2 Sheaves and Latch	
Swing (Slewing)	Hydraulic Motor Axial Plunger Type Driven, on a Ball Bearing Race. Worm and Spur Gear Reduction, Worm Self-Locking Holding Brake.	
Swing Rotation	360° Continuous Rotation (Right or Left) Non Stop	
Swing Speed	2.5 rpm	
Outriggers	Double Acting Hydraulic Cylinders with Pilot Operated Check Valves	
Oil Tank	70 Liter Capacity	
Safety Devices	Turn Over Prevention Device / Overloading Alarm / Pressure Relief Valve for Hydraulic Circuit / Counterbalance Valves for Boom Raising and Boom Telescoping Cylinders / Pilot-operated Check Valves for Vertical Outrigger Cylinders / Boom Angle Indicator with Load Indicator / Automatic Mechanical Brake for Winch / Hook Safety Latch / Overwinding Alarm / Anti two-block system / Overlowering Prevention Device / Digital Load Meter / Level / Crane and Running Lever Interlock Device / Outrigger Inter-Lock Device / Traveling Lever Inter-Lock Device / Emergency Stop Switch	

MEASUREMENTS & WEIGHT

Crane Model	UR-W376CDRS	UR-W375CDRS
① Total Width	1,300 mm	1,300 mm
② Total Height	1,800 mm	1,720 mm
③ Total Length	4,340 mm	4,250 mm
④ Wheel-Base	1,750 mm	1,750 mm
Gross Weight	3,850 kg	3,810 kg

CRAWLING GEAR

Horsepower	24.5 PS / 2,100 rpm (18 kW / 2,100 rpm)	
Fuel Tank	40 Liter Capacity	
Maximum Speed (Forward and Backward)	3.0 km / h	
Ground Length	1,750 mm	
Ground Pressure	UR-W376CDRS	0.37 kgf / cm ² (36.0 kPa)
	UR-W375CDRS	0.36 kgf / cm ² (35.6 kPa)
Steering	Left and Right Independent Hydraulic System	
Parking-brake	Hydraulic Motor built in Disk Brake	
Hill Climbing Stability	23°	

TOP & SIDE VIEWS

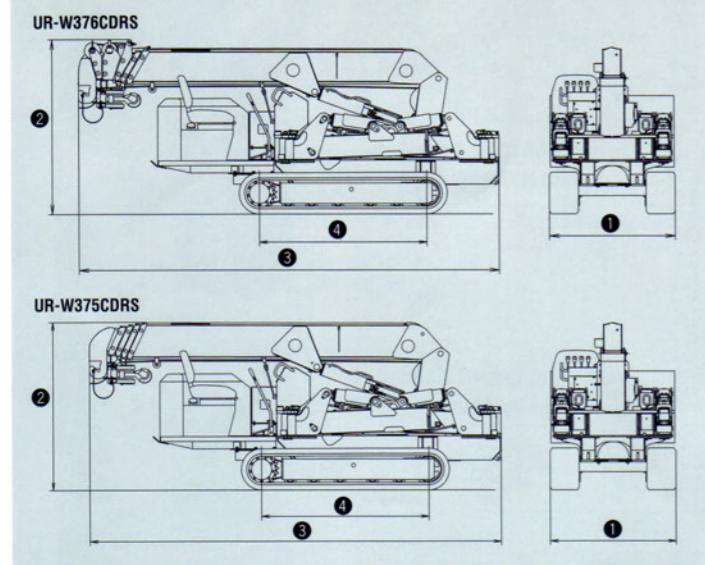

Option

200V and 400V Electric Power Pack

Clean and Silent work for interior and night operation.



Dismantle Option

Able to dismantle Boom and Outriggers, etc. and convey by helicopter and ropeway.



Dismantle and self-assemble Option

Components can be self-assembled in confined locations using the crane's own winch and tools.

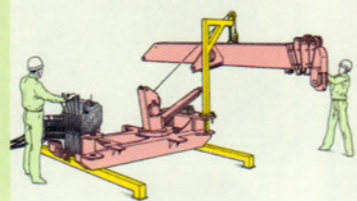

NOTE



HOOK + SLINGS + LOAD = RATED LOAD

- [1] Rated loads shown in the chart are based on the crane strength with the outriggers fully extended on a firm level ground and on the actual working radius including the deflection of boom.
- [2] The weights of hook (30 kg), slings, and any accessories attached to the boom or loadline must be deducted from the above capacities in the chart.
- [3] Capacities shown must reduce in accordance with vehicle weight and loaded condition of truck, crane mounting position, and operating speed.
- [4] The figures in relation to the speed are on the basis of no-load running at rated oil flow conditions.
- [5] In accordance with our policy of constant product improvement, all specifications are subject to change without notice or obligations.

UNIC

UNIC Mini-Crawler Crane UR-W370CD series



Photo: UR-W376CDRS (Domestic version)

FURUKAWA UNIC CORPORATION

Head Office: Center Bldg., 3-12, Higashishinagawa 2-chome, Shinagawa-ku, TOKYO 140-0002 JAPAN
 Phone: (81-3) 5460-4154 / Facsimile: (81-3) 5460-4191
 URL <http://www.furukawaunic.co.jp/>

FURUKAWA UNIC CORPORATION

High Safety

Equipped UNIC Anti-Overload system to prevent Turnover and Over Loading.
Able to work at off-road and inside buildings where Truck can not go in.



Photo: UR-W376CDRS



Radio remote control
This permits the operator to have on-the-spot hand control of lifting operations by remote control via radio waves at safe distance. It ensure safe, accurate one-man operation-with energy saving.

FEATURES

Turn Over Prevention Device

When the stability decreases, the Turn Over Prevention Device allows the alarm buzzer to beep continuously -"Beeee"- and automatically stops the crane operation.

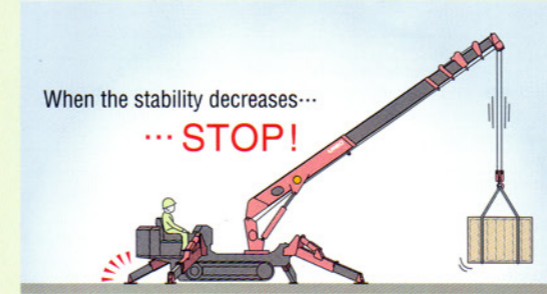

Overloading Alarm

When overload occurs, The Moment Limiter Device allows the alarm buzzer to beep continuously -"Beeee!"-

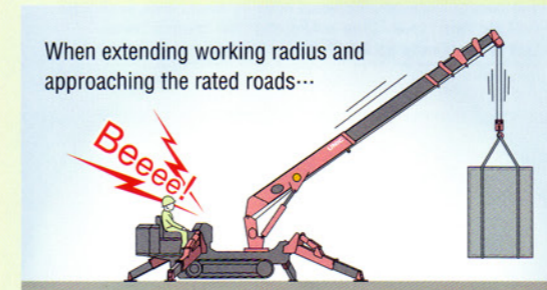

Digital Load Meter

Digital Load Meter gives cargo weight and help operators in safety work.



Outrigger Inter-Lock Device

When Boom is not retracted completely, unable to operate outriggers.

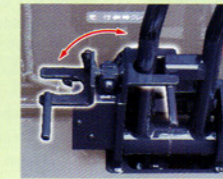

Traveling Lever Inter-Lock Device

Equipped Inter-Lock Device which switches Traveling and Operation. If mis-operate the traveling lever when operating, crane does not travel.

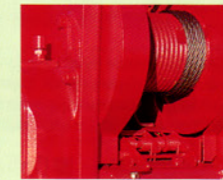

Overlowering Prevention Device

When lowering the hook below ground level, the rope winding the winch drum stops at a point 3 turns before completion to prevent the wire rope from causing damage: the overlowering prevention device.



Emergency Stop Switch

Secure the safety, so Engine and all functions are to be stopped by emergency stop.

RATED LOADS (Unit : kg)

UR-W376CDRS

Working Radius (m)	-2.5	3.0	3.5	4.0	4.5	5.0	5.69			
ALL BOOMS RETRACTED and SECOND STAGE EXTENDED	2,930	2,380	1,980	1,700	1,480	1,330	1,100			
	2,930	2,350	1,950	1,600	1,280	1,020	800			
	2,930	2,200	1,530	1,150	930	750	500			
THIRD STAGE EXTENDED	2,270	2,120	1,680	1,430	1,250	1,100	980	870	720	620
	2,270	2,090	1,680	1,420	1,200	1,030	850	670	480	400
	2,270	2,090	1,600	1,250	1,050	860	680	540	330	220
FOURTH STAGE EXTENDED	1,070	960	870	760	650	550	500	410		
	1,060	950	860	700	530	410	310	230		
	1,060	850	670	500	340	250	160	120		
FIFTH STAGE EXTENDED	780	650	510	420	370	330	300	270	260	
	780	650	500	420	350	300	250	200	160	
	780	650	430	280	210	160	120	90	40	
SIXTH STAGE EXTENDED	330	300	280	250	230	210	190	170	160	140
	330	300	280	250	230	210	190	150	120	90
	330	300	280	250	200	140	110	80	60	50

UR-W375CDRS

Working Radius (m)	-2.5	3.0	3.5	4.0	4.5	5.0	5.62			
ALL BOOMS RETRACTED and SECOND STAGE EXTENDED	2,930	2,380	1,980	1,700	1,480	1,330	1,150			
	2,930	2,360	1,960	1,680	1,350	1,050	800			
	2,930	2,330	1,650	1,250	930	780	650			
THIRD STAGE EXTENDED	2,270	2,120	1,680	1,430	1,250	1,100	980	870	720	620
	2,270	2,090	1,680	1,420	1,240	1,070	950	800	500	330
	2,270	2,090	1,680	1,330	1,050	850	680	560	380	290
FOURTH STAGE EXTENDED	1,070	980	880	770	670	570	500	430		
	1,060	950	860	700	550	410	310	240		
	1,060	950	840	600	420	300	200	140		
FIFTH STAGE EXTENDED	780	650	510	420	370	330	300	270	260	
	780	650	500	410	360	300	250	190	140	
	780	650	500	410	340	270	200	140	80	

Outrigger Position

UR-W376CDRS

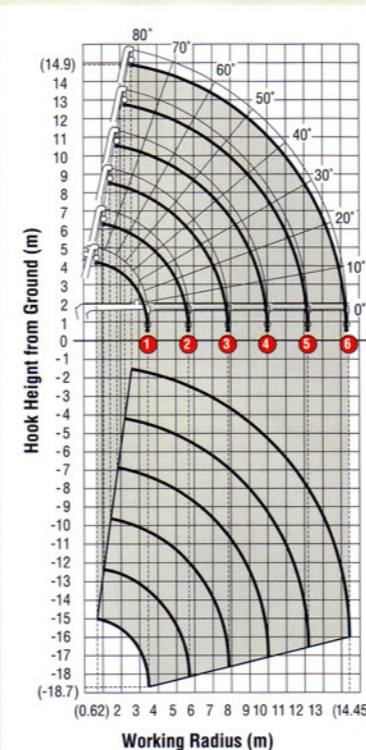

UR-W375CDRS

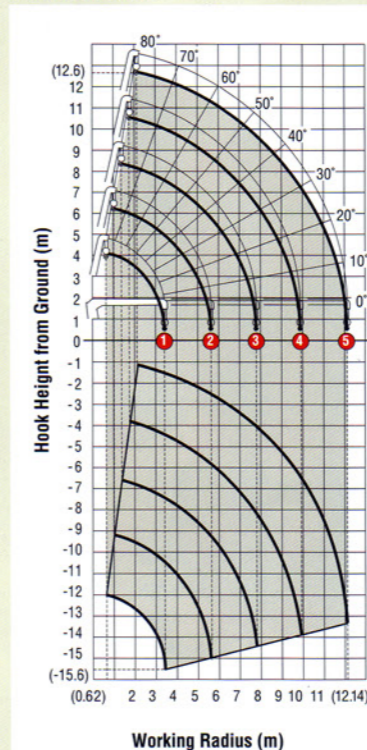

Outrigger Extended to Maximum



Outrigger Extended to Halfway



Outrigger Extended to Minimum

