

Manitowoc 16000

Product Guide

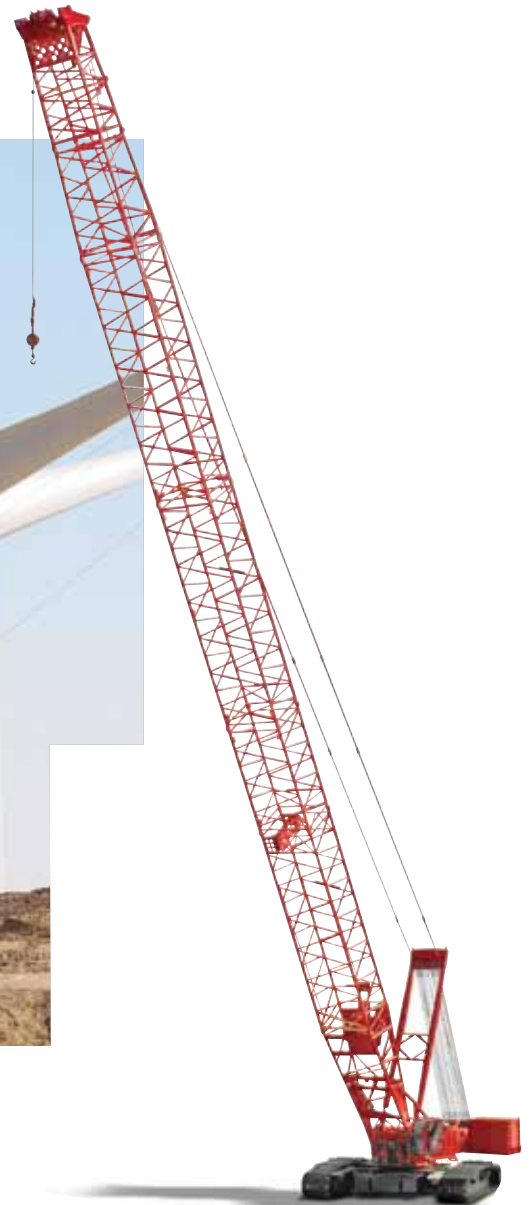

Features

- 400 t (440 USt) capacity
- 2 599 mton-m (18,800 ft-kips) maximum load moment
- 5 066 mton-m (36,405 ft-kips) maximum load moment with MAX-ER®
- 96 m (315 ft) heavy-lift boom
- 138 m (453 ft) luffing jib on heavy-lift boom
- 372 kW (500 HP) engine

Features

EPIC®

Manitowoc's field-proven Electronically Processed Independent Controls (EPIC) system delivers high productivity and precise load control by instantly matching a crane's commands to the crane function. EPIC's microprocessor maximizes a Manitowoc crane's function capability and simplifies servicing by pinpointing any problem in the crane's engine, power transmission and other operating systems. In addition, EPIC increases versatility by easily tailoring a Manitowoc crane's operation for specialized applications, with or without attachments. EPIC is a key reason no other crane can match the performance and reliability of Manitowoc.



FACT™ Connectors

Manitowoc's patented Fast Aligning Connection Technology (FACT) precisely aligns crane components for safe, fast, easy assembly.



Crawler Drive Shafts

These eliminate the need to disconnect hydraulic systems for shipment—simplifying crawler removal and assembly.

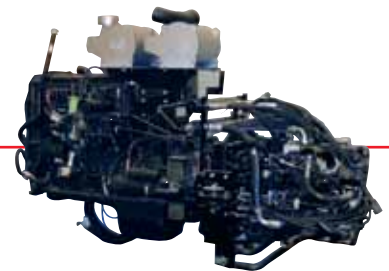

Hydraulics

Our closed-loop system provides a separate hydraulic circuit to power each crane function. The result is truly independent, variable-speed operation of the swing, load hoist, boom hoist and travel functions.

Contents

Specifications	4
Outline dimensions	8
Transport data	15
Crane assembly	16
Performance data	19
Boom combinations	24
Heavy lift boom range / load charts	26
Upper boom point range / load charts	28
Luffing jib range / load charts	32
MAX-ER® complete information	36
Manitowoc Crane Care	48

Specifications

Upperworks



Engine

Cummins Model QSX15 – C500 diesel, 6 cylinder, 372 kW (500 BHP) at 1800 governed RPM.

Includes pump drive disconnect for easier starting, engine block heater (120V), ether starting aid, high silencing muffler, hydraulic oil cooler, radiator and fan.

Multiple hydraulic pump drive transmission provides power for all machine functions.

Two 12 volt maintenance-free batteries, 1400 CCA at -18°C (0° F), 24 volt system and 100 amp alternator.

One diesel fuel tank, 946 L. (250 gal.), with level indicator in operator's cab.

Optional: Cold-weather package with heater for fluids, and computer display.



Controls

Modulating electronic-over-hydraulic controls provide infinite speed response directly proportional to control lever movement. Controls include Manitowoc's exclusive EPIC® Electronically Processed Independent Control system with CAN-BUS technology providing microprocessor driven control logic, pump control, on-board diagnostics, and service information.

Block-up limit control is standard for hoist and whip lines.

Integrated Rated Capacity Limiter system (RCL) is standard for main boom and upper boom point. "Function cut-out" or "warning only" operation is selected via a keyed switch on the RCL console.

Travel and swing alarms are standard.

➤ Optional: Anemometer (wind speed indicator). Booms and jibs are pre wired for anemometer.



Hydraulic system

Six high-pressure piston pumps, driven by a multi-pump transmission, provide independent closed-loop hydraulic power for the hoisting drums, boom hoist, swing, left crawler and right crawler.

Hydraulic reservoir capacity is 719 L. (190 gal.) and is equipped with breather, clean out access, and internal diffuser.

Each function is equipped with relief valves to protect the hydraulic circuit from overload or shock.

System includes oil cooler and replaceable, full flow filter. All oil is filtered before entering the hydraulic pumps.

Hydraulic system also includes pump transmission disconnect and hydraulic oil cooler.



Drums

Basic machine is equipped with 108,6 cm (42-3/4") wide and 64,1 cm (25-1/4") diameter main hoist drum, mounted in the boom butt, and 82,2 cm (32-3/8") wide and 64,1 cm (25-1/4") diameter whip drum, mounted in the rotating bed. Each end of the main drum is driven by a variable-displacement hydraulic motor through a planetary reduction. The whip drum is driven by an independent variable-displacement hydraulic motor thru a planetary reduction. Drums are grooved for 28 mm rope.

Powered hoisting/lowering operation is standard with automatic (spring applied, hydraulically released) multi-disc brakes, and drum rotation indicators.

➤ Optional: Auxiliary (third) hydraulic powered drum rated 147 kN (33,000 lb) line pull mounted in boom butt. Includes third drum control system.

➤ Optional: Auxiliary drum preparation includes electric wiring, controls, hydraulic pump and plumbing.



Swing system

Bearing adapter-mounted independent swing is powered by a fixed-displacement hydraulic motor coupled to an internal brake and planetary reduction. Includes Manitowoc Patented swing lock.

Swing system maximum speed: 2.2 rpm.



Moving mast hoist system

Independent moving mast hoist with two grooved drums, each 32,5 cm (12-13/16") wide and 64,1 cm (25-1/4") diameter drum grooved for 1-1/8" diameter

Specifications

wire rope. Includes 498 m (1,620') of 1-1/8" wire rope for 26-part line reeving.

Drum is powered by 2 variable-displacement hydraulic motors coupled to integral brake and planetary reduction gearboxes. Ratcheting pawl and rotation indicator are standard.



Moving mast hoist speed

Raise 96 m (315') full main boom from 0° - 82° in 3 minutes, 48 seconds.



Boom support system

Moving Mast

Moving Mast is 9,75 m (32') long and connects the boom hoist reeving to the steel boom suspension strap rigging. When used with the optional self-erect package, the mast is used for crane assembly and disassembly. It is capable of lifting and positioning the crawler assemblies, stacking the counterweights, and assembling the boom and luffing jib.

Spring cushioned boom stop and automatic boom stop are standard.



Counterweight

Counterweight tray and counterweights for the upperworks attaches to the rotating bed with power actuated pins.

QTY.	ITEM	UNIT WEIGHT		TOTAL WEIGHT	
		kg	lb	kg	lb
10	Upperworks Upper Side Box	8 164	18,000	81 640	180,000
1	Counterweight Tray	19 958	44,000	19 958	44,000
Series 1 Total				101 598	224,000
4	Upperworks Upper Side Box	8 164	18,000	32 656	72,000
2	Carbody Center Box	13 608	30,000	27 216	60,000
Series 2 Total				161 470	356,000
2	Upperworks Upper Side Box	8 164	18,000	16 328	36,000
4	Carbody Side Box	6 804	15,000	27 216	60,000
Series 3 Total				205 014	452,000



Vision operator's cab

The Vision Cab™ is a fully enclosed and insulated steel module mounted to the left front corner of rotating bed. Module is equipped with power tilt, sliding door, large safety glass windows, front and roof windshield wipers, dome light, sun visor and shade, fire extinguisher, air conditioning, swing and travel alarms, and radio/CD player are standard equipment. Operator's station swings over front of rotating bed for transportation.

Optional: Nylon protective window covers.

Lowerworks



Carbody

Connects rotating bed to crawler assemblies. High strength fabricated steel assembly with FACT™ connection system for safe, fast installation and removal of crawler assemblies.



Crawlers

Crawler assemblies are 10,4 m (34' 2") long with 1,5 m (60") wide cast steel crawler pads and automatically lubricated intermediate rollers. Each crawler is identical and can be mounted on either side of the carbody. Each crawler is powered independently by a variable displacement hydraulic motor and includes two hydraulically powered pin actuators for fast installation and removal from carbody. Carbody mounted drive motors are connected to crawler final reduction via drive shaft with guard. Crawlers provide ample tractive effort for counter rotation with full rated load.

Maximum ground speed of 1,24 kph (0.77 mph).

Attachments



No. 58 heavy-lift boom

The liftcrane is equipped with 30 m (98') No. 58 basic boom consisting of 8 m (26' 3") butt, 12 m (39' 5") insert with luffing hoist sheaves, 5 m (16' 5") transition insert, and 5 m (16' 5") top with thirteen 76,2 cm (30") diameter tapered roller bearing sheaves. Includes rope guides, boom hoist wire rope, boom angle indicator and 771 kg (1,700 lb) hook and weight ball. The boom connectors utilize Manitowoc's patented exclusive FACT™ connection system boom connector. Spring cushioned boom stop. Automatic boom stop.

Specifications

Powered boom hinge system including cylinder, piping, operating controls, and locking device standard.

Luffing jib preparation included as standard.

➤ Optional: 6 m (19' 8") and 12 m (39' 5") No. 58 boom inserts with steel boom suspension straps and FACT connection system.

Utilize main boom inserts in combination with No. 58 basic main boom for total length up to 96 m (315').

➤ Optional: No. 58 detachable upper boom point with one 76,2 cm (30") diameter tapered roller bearing steel sheave grooved for 28 mm rope with rope guard for liftcrane.

➤ Optional: Heavy-duty 97,6 t (107.6 USt) detachable extended upper boom point with three 76,2 cm (30") diameter tapered roller bearing steel sheave grooved for 28 mm rope with rope guard for liftcrane.



No. 59 luffing jib

➤ Optional: 24 m (78') basic No. 59 luffing jib with LMI hardware for "lay out" assembly including PIN connected 7 m (23') butt, (1) 6 m (19' 8") inserts and 11 m (36') top, basic pendants, fixed strut, jib strut, backstay pendants, boom point guide wheel, luffing jib hoist with ratchet and pawl; quick disconnect for jib hoist piping, and 1" luffing jib hoist line (luffing jib preparation is standard).

➤ Optional: 6 m (19' 8") and 12 m (39' 5") No. 59 luffing jib inserts with steel boom suspension straps and FACT connection system.

Utilize luffing jib inserts in combination with the No. 59 basic luffing jib for total lengths up to 84 m (275').



The Wheeled MAX-ER®

The Wheeled MAX-ER® attachment components include:

30 m of No. 59A mast consisting of a 6 m (19.7) butt, 6 m (19.7) insert, 12 m (39.4) insert and 6 m (19.7) top.

One additional swing drive (for a total of two) mounted on the rotating module. Each swing drive is powered by a fixed-displacement hydraulic motor coupled to a planetary reduction gearbox and internal brake.

Two 12 m (39' 5") heavy No. 58 boom inserts.

The wheeled MAX-ER® counterweight assembly attaches to the top of the mast by steel straps and to the rear of the upperworks by a telescopic beam assembly.

Counterweight includes (8) 19 958 kg (44,000 lb) and (2) 13 608 kg (30,000 lb) boxes.

The wheeled MAX-ER® counterweight can be positioned 11 m (36.1'), 13 m (42.7'), or 15 m (49.2') behind the crane's centerline of rotation, utilizing structural stinger equipped with hydraulic cylinder.

The wheeled counterweight uses large off-road tires, which can be positioned for traveling or swinging. It also includes hydraulic support jacks and pads.



The Hanging MAX-ER®

The Hanging MAX-ER® attachment components include:

30 m of No. 59A mast consisting of a 6 m (19.7) butt, 6 m (19.7) insert, 12 m (39.4) insert and 6 m (19.7) top.

One additional swing drive (for a total of two) mounted on the rotating module. Each swing drive is powered by a fixed-displacement hydraulic motor coupled to a planetary reduction gearbox and internal brake.

Two 12 m (39' 5") heavy No. 58 boom inserts.

The hanging MAX-ER® counterweight assembly attaches to the top of the mast by steel straps and to the rear of the upperworks by a beam assembly.

Counterweight includes (10) 19 958 kg (44,000 lb) and (2) 6 804 kg (15,000 lb) boxes.

The hanging MAX-ER® counterweight can be positioned 11 m (36.1'), 13 m (42.7'), or 15 m (49.2') behind the crane's centerline of rotation.

Optional equipment

➤ Optional: Blocks and Hooks, each with roller-bearing sheaves for 28 mm wire rope, a roller-bearing swivel hook, a hook latch, and a swivel lock.

➤ Optional: 18,1 t (20 USt) swivel hook and weight ball. Single line pull is 13 610 kg (30,000 lb).

➤ Optional: 41 t (45 USt) hook block with single roller bearing sheave and roller bearing swivel hook with hook latch and swivel lock (assembly block).

➤ Optional: Rated 100 t (110 USt) hook block with

Specifications

three roller bearing sheaves and roller bearing swivel hook with hook latch and swivel lock.

- Optional: 180 t (200 USt) hook block with five roller bearing sheaves and roller bearing swivel hook with hook latch and swivel lock.
- Optional: 226 t (250 USt) hook block with seven roller bearing sheaves and roller bearing swivel hook with hook latch and swivel lock.
- Optional: 317 t (350 USt) hook block with seven roller bearing sheaves and roller bearing swivel hook with hook latch and swivel lock.
- Optional: 408 t (450 USt) hook block with thirteen roller bearing sheaves and roller bearing swivel hook with hook latch and swivel lock.
- Optional: Self-erect system includes, jacking cylinders with pads, 41 t (45 USt) assembly block and crawler handling chains.
- Optional: Hydraulic Test Kit: required to properly analyze the performance of the EPIC® control system.
- Optional: Service Interval Kits for the regularly scheduled maintenance of general crane operations.
- Optional: Lighting Packages: consult dealer for available options.
- Optional: Special Paint color(s) other than Manitowoc standard red and black.
- Optional: Custom vinyl decal(s) of customer name and/or logo from artwork supplied by customer.
- Optional: Export Packaging: basic crane, boom and jib sections.

See hoist reaving for main load block chart for actual capacity when used with 16000.

Hoist reaving for main load block Single lead line 28 mm - Boom No. 58 HL

No. parts of line	Maximum load	
	kg	(lb)
2	32 520	71,700
4	65 090	143,500
6	97 610	215,200
8	130 180	287,000
10	162 750	358,800
12	195 270	430,500
14	227 840	502,300
16	260 360	574,000
18	292 930	645,800
20	322 690	711,400
22	351 530	775,000
24	379 840	837,400
26	400 000	881,900

Note: 16000 can only be reeved even numbered parts of line.

Outline dimensions

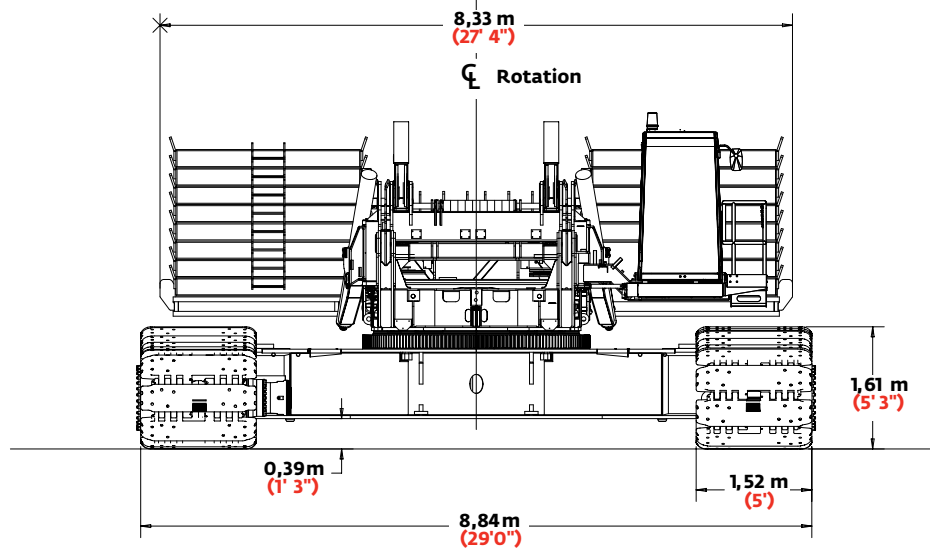
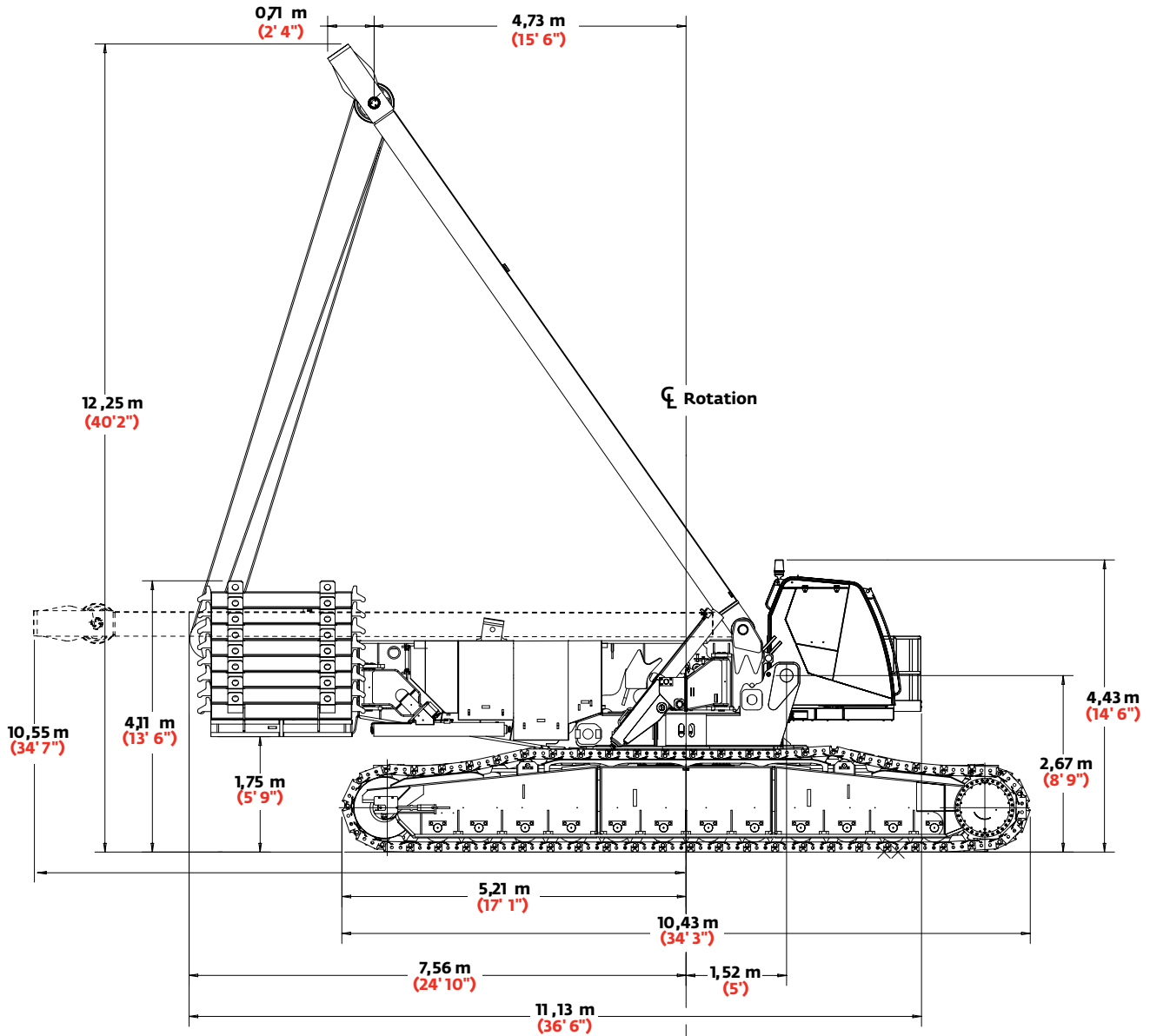

Outline dimensions

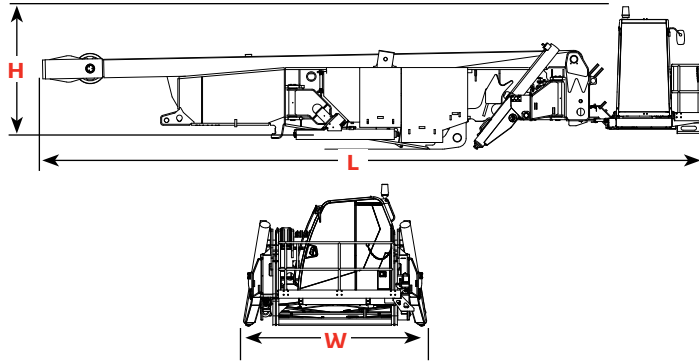

Rotating bed assembly

Length	13,25 m	43' 6"
Width	3,20 m	10' 6"
Height	2,87 m	9' 5"
Weight	39 612 kg	87,330 lb

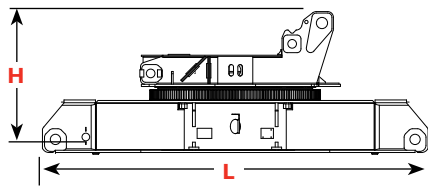

Carbody assembly

Length	6,78 m	22' 3"
Width	3,00 m	9' 10"
Height	2,52 m	8' 3"
Weight	28 161 kg	62,085 lb

Note: Weight includes rotating bed adapter frame with bearing turntable, four swing drives, and carbody.

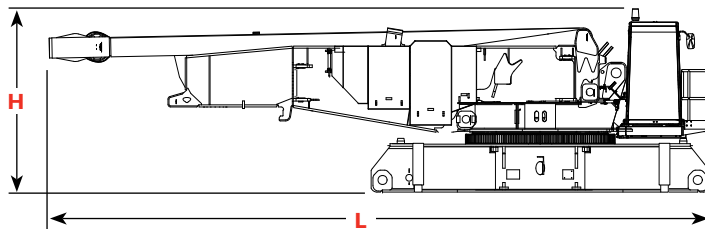

Rotating bed and carbody assembly (decked version)

Length	6,78 m	22' 3"
Width	3,00 m	9' 10"
Height	3,20 m	10' 6"
Weight	64 982 kg	143,260 lb

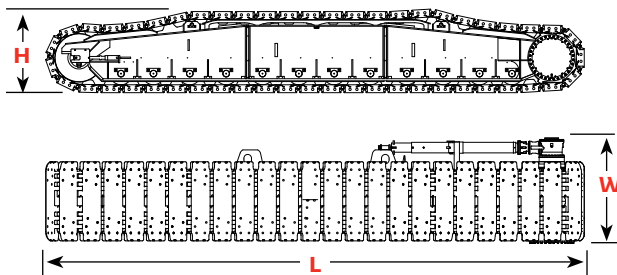

Crawlers

Length	10,43 m	34' 3"
Width	2,03 m	6' 8"
Height	1,61 m	5' 3"
Weight	32 665 kg	72,015 lb

► Option

Outline dimensions

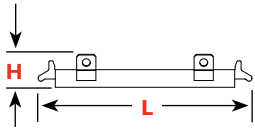

Upper counterweight

Series 1	x 10
Series 2	x 14
Series 3	x 16

Length	2,54 m	8' 4"
Width	2,61 m	8' 7"
Height	0,41 m	1' 4"
Weight	8 164 kg	18,000 lb

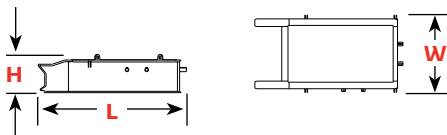

Carbody center counterweight

Series 2	x 2
Series 3	x 2

Length	3,45 m	11' 4"
Width	1,80 m	5' 11"
Height	0,89 m	2' 11"
Weight	13 607 kg	30,000 lb

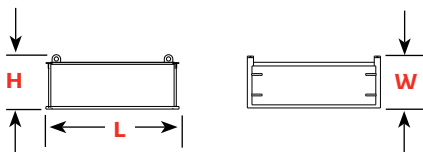

Carbody side counterweight

Series 3	x 4
----------	-----

Length	2,18 m	7' 2"
Width	0,86 m	2' 10"
Height	0,89 m	2' 11"
Weight	6 803 kg	15,000 lb

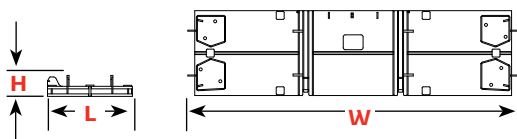

Upper counterweight tray

Length	2,14 m	7' 0"
Width	8,33 m	27' 4"
Height	0,53 m	1' 9"
Weight	19 958 kg	44,000 lb

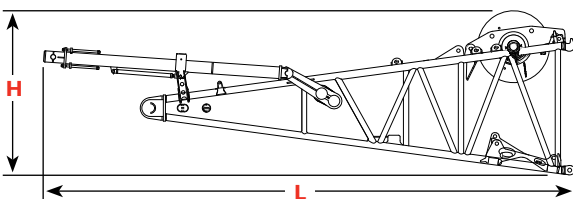

No. 58 Boom butt, drum 1, luffing drum, wire rope

	x 1	
Length	10,13 m	33' 3"
Width	2,96 m	9' 9"
Height	3,10 m	10' 2"
Weight	21 609 kg	47,640 lb

Option

Outline dimensions

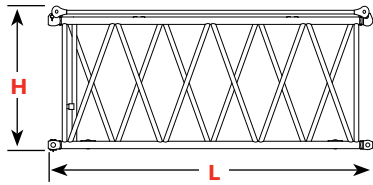

No. 58 boom insert 6,0 m (19' 8'') and straps x 1

Length	6,19 m	20' 3"
Width	2,96 m	9' 9"
Height	2,67 m	8' 9"
Weight	2 562 kg	5,650 lb

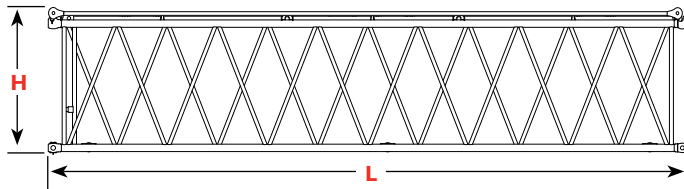

No. 58 boom insert 12,0 m (39' 5'') and straps x 1

Length	12,19 m	40' 0"
Width	2,96 m	9' 9"
Height	2,65 m	8' 8"
Weight	4 236 kg	9,340 lb

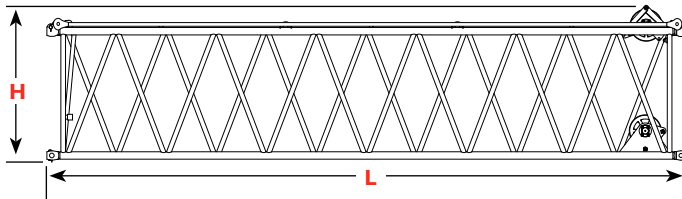

No. 58 boom insert heavy 12,0 (39' 5'') with sheave x 1

Length	12,19 m	40' 0"
Width	2,96 m	9' 9"
Height	2,67 m	8' 9"
Weight	5 595 kg	12,335 lb

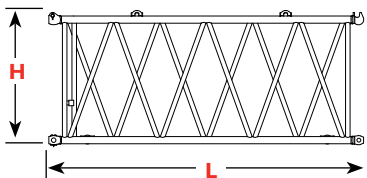

No. 58 WA boom insert 6,0 m (19' 8'') and straps x 1

Length	6,19 m	20' 4"
Width	2,96 m	9' 9"
Height	2,67 m	8' 9"
Weight	2 690 kg	5,930 lb

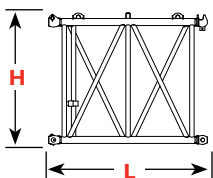

No. 58 WA boom insert 3,0 m (9' 10'') and straps x 1

Length	3,19 m	10' 6"
Width	2,96 m	9' 9"
Height	2,67 m	8' 9"
Weight	1 599 kg	3,525 lb

Option

Outline dimensions

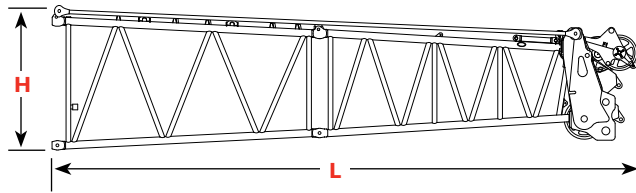

No. 58 boom top 5,0 m (16' 5") with 5,0 (16' 5") transitional insert and straps x 1

Length	11,41 m	37' 5"
Width	2,96 m	9' 9"
Height	2,67 m	8' 9"
Weight	11 373 kg	25,075 lb

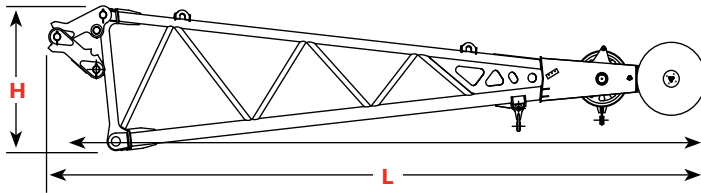

No. 58 extended upper boom point 7,0 m (23' 0") x 1

Length	9,52 m	31' 3"
Width	2,60 m	8' 6"
Height	1,99 m	6' 6"
Weight	3 674 kg	8,100 lb

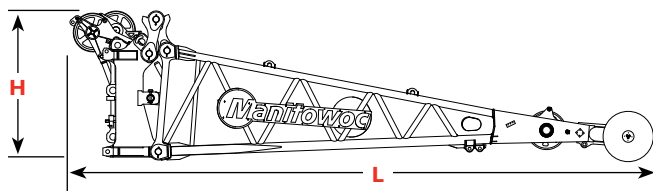

No. 58 WA boom cap and No. 58 WA extended upper boom point x 1

Length	11,50 m	37' 9"
Width	2,70 m	8' 10"
Height	2,97 m	9' 9"
Weight	8 519 kg	18,780 lb

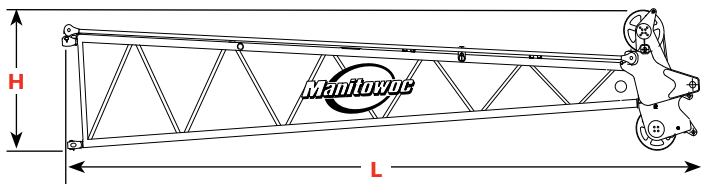

No. 59 luffing jib top 11,0 (36' 1") x 1

Length	11,95 m	39' 2"
Width	2,69 m	8' 10"
Height	2,54 m	8' 4"
Weight	6 015 kg	13,260 lb

▶ Option

Outline dimensions

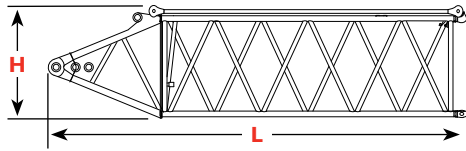

No. 59 luffing jib butt		
7,0 (23' 0")		
		x 1
Length	7,15 m	23' 6"
Width	2,69 m	8' 10"
Height	2,17 m	7' 1"
Weight	2722 kg	6,000 lb

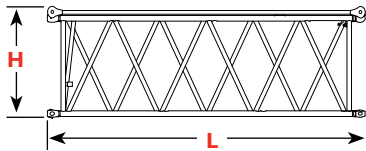

No. 59 luffing jib insert		
6,0 (19' 8")		
		x 1
Length	6,19 m	20' 3"
Width	2,69 m	8' 10"
Height	2,17 m	7' 1"
Weight	1685 kg	3,715 lb

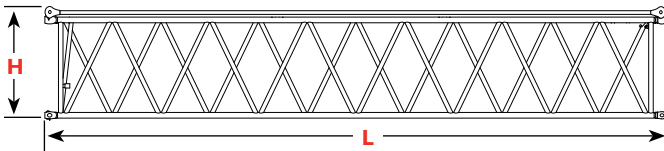

No. 59 luffing jib insert		
12,0 (39' 5")		
		x 1
Length	12,19 m	40' 0"
Width	2,69 m	9' 9"
Height	2,17 m	7' 1"
Weight	2928 kg	6,455 lb

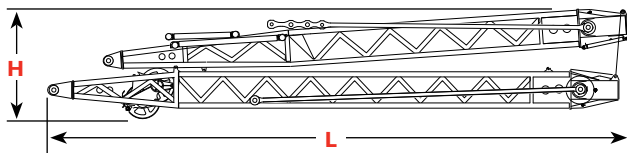

No. 59 luffing jib strut with point sheaves and straps		
11,5 m (37' 9")		
		x 1
Length	12,46 m	40' 11"
Width	2,69 m	8' 10"
Height	2,27 m	7' 5"
Weight	9287 kg	20,475 lb

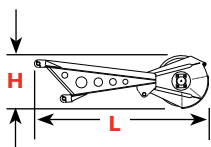

No. 59 luffing jib upper point roller assembly		
11,5 m (37' 9")		
		x 1
Length	2,64 m	8' 8"
Width	0,41 m	1' 4"
Height	0,81 m	2' 8"
Weight	460 kg	1,014 lb

Option

Outline dimensions

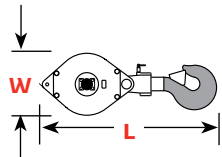

Hook block for 28 mm (1-1/8") wire rope					
Capacity	410 mt	450 t	Length	3,37 m	11' 1"
Weight	9 661 kg	21,300 lb	Width	1,19 m	3' 11"
Capacity	317 mt	350 t	Length	2,63 m	8' 8"
Weight	7 892 kg	17,400 lb	Width	1,15 m	3' 9"
Capacity	227 mt	250 t	Length	2,72 m	8' 11"
Weight	5 257 kg	11,590 lb	Width	0,93 m	3' 0"
Capacity	182 mt	200 t	Length	2,65 m	8' 8"
Weight	4 308 kg	9,500 lb	Width	0,87 m	2' 10"
Capacity	100 mt	110 t	Length	2,28 m	7' 6"
Weight	3 404 kg	7,500 lb	Width	0,86 m	2' 10"
Capacity	41 mt	45 t*	Length	1,90 m	6' 3"
Weight	1 179 kg	2,600 lb	Width	0,91 m	3' 0"

*Assembly block

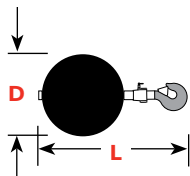

Weight ball					
Capacity/Swivel	18 mt	20 t	Diameter	0,47 m	1' 7"
Weight	771 kg	1,700 lb	Length	1,23 m	4' 0"

Transport data

Model 16000 trailer load out summary

Weight each item	No. 58 Boom 108 m (354 ft) with No. 58 extended upper boom point 7 m (23 ft)																			
	Quantity on trailer load #																			
Item	kg (lb)	1	2	3	4	5	6	7	8	9	10	11	12	13	14	15	16	17	18	19
Upperworks module	39 612 (87,330)	1																		
Carbody and adapter	28 161 (62,085)		1																	
Crawler assembly	32 665 (72,015)			1	1															
Counterweight tray	19 958 (44,000)																	1		
Upper counterweight (Box)	8 164 (18,000)					1		1	1	2	1	2	1	1	2	2	2			
Carbody center counterweight	13 607 (30,000)																		1	1
Carbody side counterweight	6 803 (15,000)							1	1										1	1
8,0 m (262 ft) No. 58 boom butt, drum 1 w/ wire rope	21 609 (47,640)						1													
5,0 m (16 ft 5 in) No. 58 boom top and straps	9 169 (20,215)					1														
5,0 m (16 ft 5 in) No. 58 boom trans. insert and straps	2 204 (4,860)					1														
6,0 m (19 ft 8 in) No. 58 boom insert and straps	2 562 (5,650)														1					
12,0 m (39 ft 5 in) No. 58 boom with WRG Boom insert and straps	5 595 (12,335)							1												
12,0 m (39 ft 5 in) No. 58 boom insert and straps	4 236 (9,340)								1	1	1	1	1	1						
No. 59 Upper boom point	460 (1,014)														1					
No. 58 Extended upper boom point 7 m (23 ft)	3 674 (8,100)															1				
180 t (200 USt) 5 sheave load block	4 309 (9,500)										1									
100 t (110 USt) 3 sheave load block	3 402 (7,500)													1						
Reel cable - 701 m (2,300 ft)	3 629 (8,000)												1							
Miscellaneous	907 (2,000)																1			
		39 612 (87,330)	28 161 (62,085)	32 665 (72,015)	32 665 (72,015)	19 538 (43,075)	21 609 (47,640)	20 562 (45,335)	19 203 (42,340)	20 564 (45,340)	16 705 (36,840)	20 564 (45,340)	16 029 (35,340)	15 802 (34,840)	19 350 (42,664)	20 002 (44,100)	18 414 (40,600)	19 958 (44,000)	20 410 (45,000)	20 410 (45,000)
		1	2	3	4	5	6	7	8	9	10	11	12	13	14	15	16	17	18	19

* Note: Does not include blocking, strapping etc.

Crane assembly - undecked

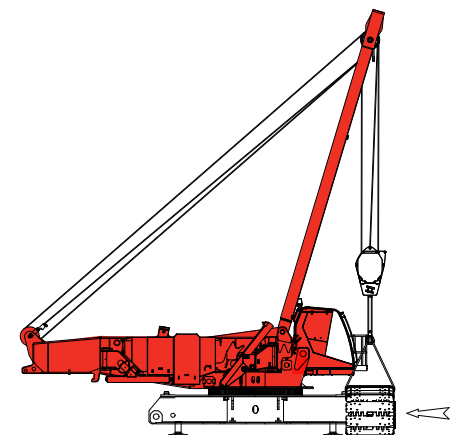
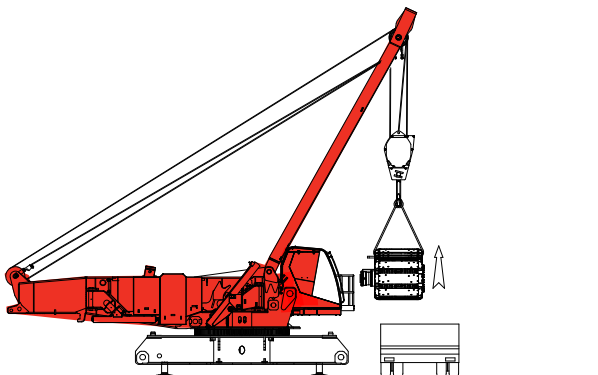
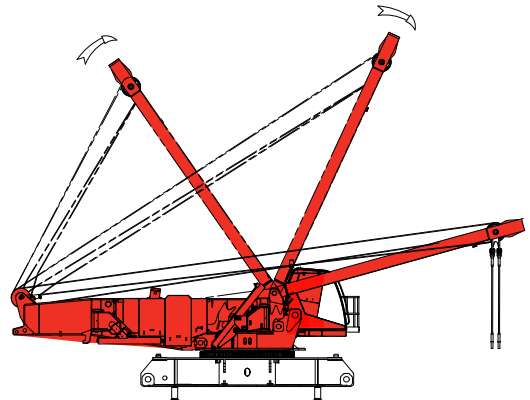
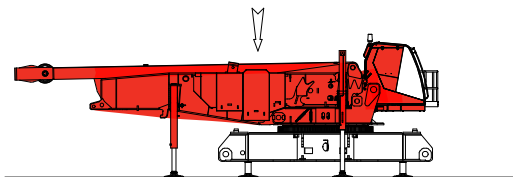
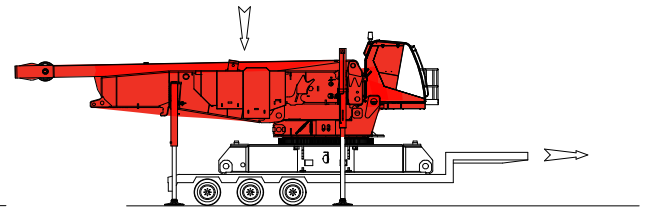
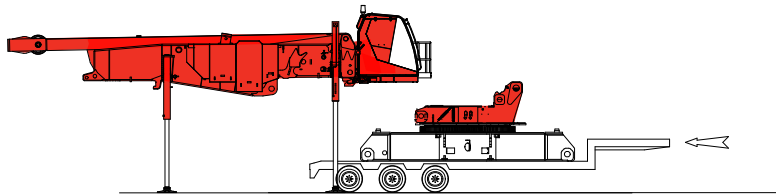
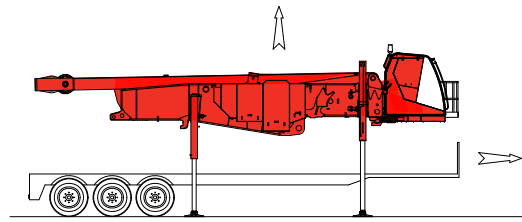
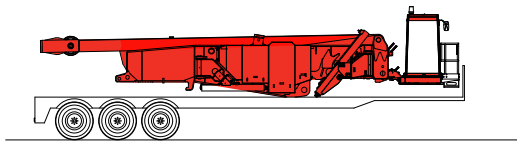

Crane assembly - undecked

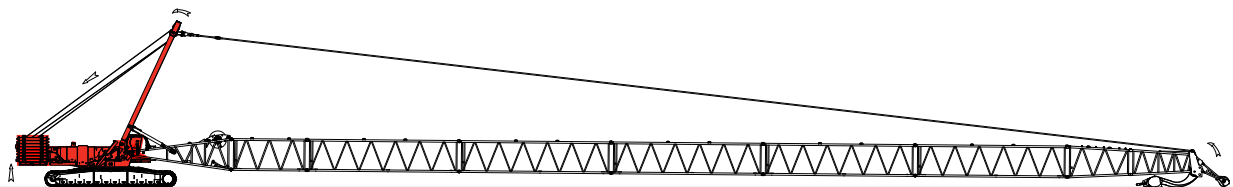
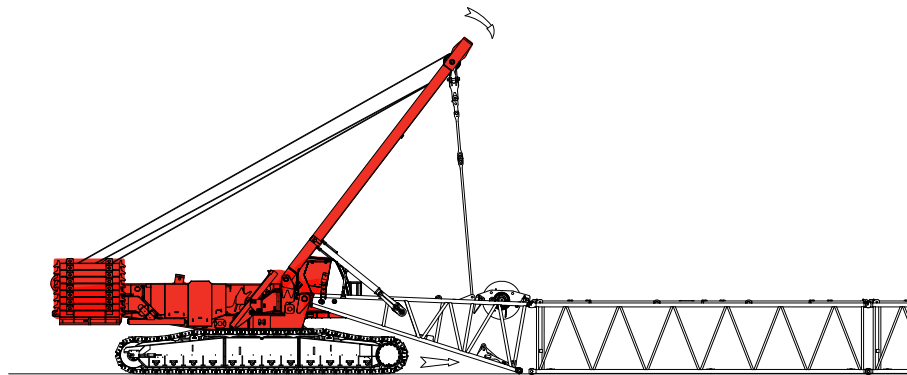
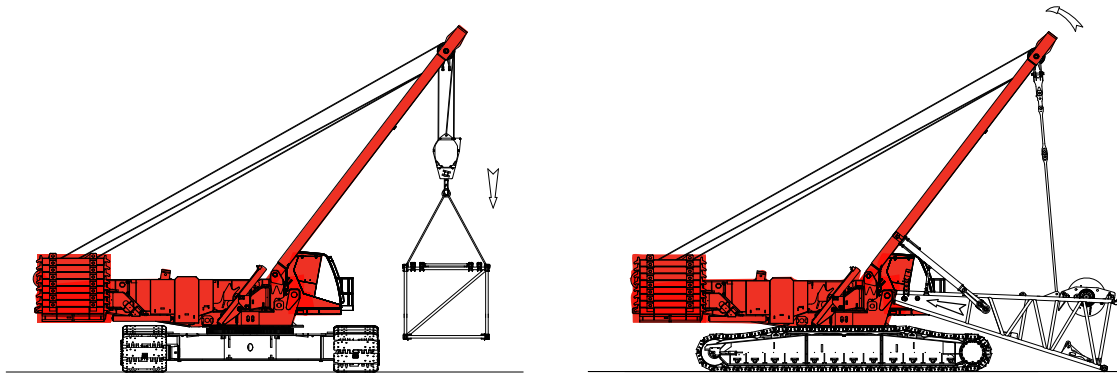
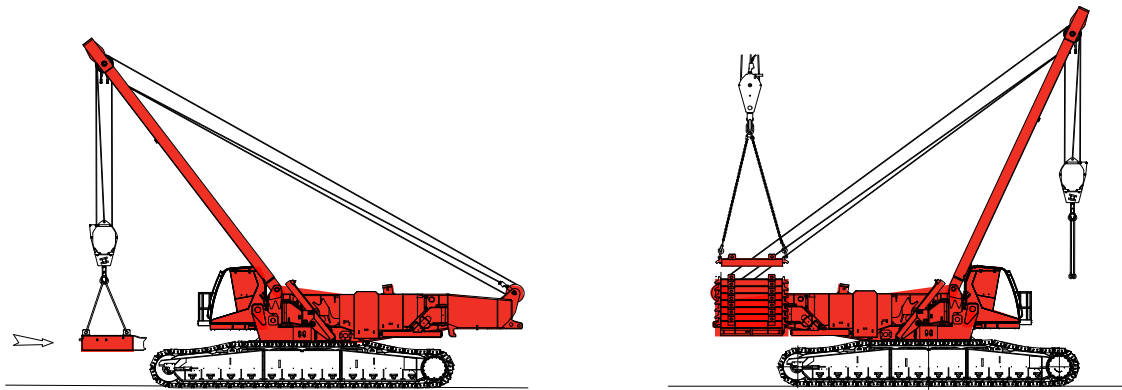

Crane assembly - decked

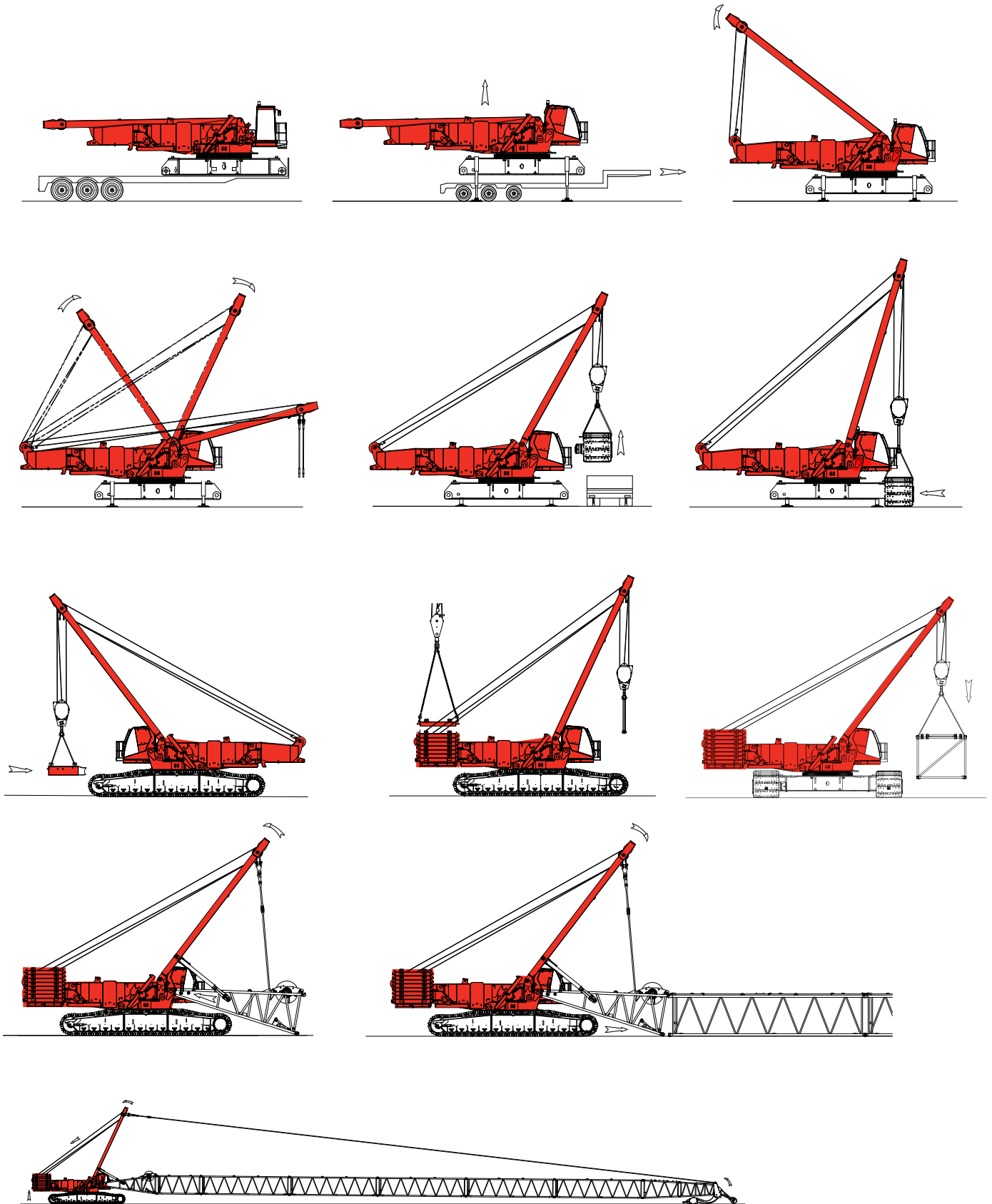

Performance data

Performance for main hoist (drum #1)
28 mm wire rope - 11 layers maximum working - drum barrel groove root diameter 641.35 mm (25.5 in)
Single line speed in m (ft) per minute

Layer Single line pull Radius Single line pull kg (lb)	1 335 mm (13.2")	2 363 mm (14.3")	3 391 mm (15.4")	4 419 mm (16.5")	5 447 mm (17.6")	6 475 mm (18.7")	7 503 mm (19.8")	8 531 mm (20.9")	9 559 mm (22.0")	10 587 mm (23.1")	11 615 mm (24.2")
0 (0)	105 (345)	114 (374)	123 (403)	132 (432)	140 (460)	149 (489)	158 (518)	167 (547)	176 (576)	184 (605)	193 (634)
2 268 (5,000)	105 (345)	114 (374)	123 (403)	132 (432)	140 (460)	149 (489)	158 (518)	167 (547)	176 (576)	184 (605)	193 (634)
4 536 (10,000)	105 (345)	114 (374)	123 (403)	131 (430)	139 (456)	147 (481)	154 (506)	162 (530)	169 (554)	176 (577)	183 (601)
6 804 (15,000)	103 (337)	110 (361)	117 (385)	124 (408)	131 (430)	135 (442)	136 (446)	137 (450)	138 (453)	139 (457)	141 (461)
9 072 (20,000)	98 (322)	101 (332)	102 (336)	104 (340)	105 (344)	106 (348)	107 (352)	108 (355)	109 (359)	111 (363)	112 (367)
11 340 (25,000)	83 (272)	84 (276)	85 (280)	87 (284)	87 (287)	89 (291)	90 (295)	91 (299)	92 (303)	94 (307)	95 (311)
13 608 (30,000)	71 (234)	73 (238)	74 (242)	75 (246)	76 (250)	77 (254)	78 (257)	80 (261)	81 (265)	82 (269)	83 (273)
16 239 (35,800)	62 (204)	63 (208)	65 (212)	66 (215)	67 (219)	68 (223)	69 (227)	70 (231)	72 (235)	73 (239)	74 (242)

Performance for standard whip (drum #2)
28 mm wire rope - 7 layers maximum working
Drum barrel groove root diameter 641.35 mm (25.5 in)
Single line speed in m (ft) per minute

Layer Single line pull Radius Single line pull kg (lb)	1 335 mm (13.2")	2 363 mm (14.3")	3 391 mm (15.4")	4 419 mm (16.5")	5 447 mm (17.6")	6 475 mm (18.7")	7 503 mm (19.8")
0 (0)	85 (278)	92 (301)	99 (324)	106 (347)	113 (370)	120 (394)	127 (417)
2 268 (5,000)	80 (262)	86 (283)	92 (303)	98 (323)	105 (343)	111 (363)	116 (382)
4 536 (10,000)	75 (247)	81 (265)	86 (282)	91 (299)	96 (316)	101 (330)	101 (333)
6 804 (15,000)	68 (222)	69 (225)	69 (228)	70 (230)	71 (233)	72 (236)	73 (239)
9 072 (20,000)	53 (175)	54 (178)	55 (181)	56 (183)	57 (186)	58 (189)	59 (192)
11 340 (25,000)	45 (147)	45 (149)	46 (152)	47 (155)	48 (158)	49 (161)	50 (164)
13 608 (30,000)	39 (128)	40 (131)	41 (133)	41 (136)	42 (139)	43 (142)	44 (145)

Performance data

Performance for optional high speed whip (drum #2) 28 mm wire rope - 7 layers maximum working drum barrel groove root diameter 641.35 mm (25.5 in) single line speed in m (ft) per minute							
Layer	1	2	3	4	5	6	7
Single line pull	335 mm (13.2")	363 mm (14.3")	391 mm (15.4")	419 mm (16.5")	447 mm (17.6")	475 mm (18.7")	503 mm (19.8")
Radius							
Single line pull kg (lb)							
0 (0)	105 (345)	114 (374)	123 (403)	132 (432)	140 (460)	149 (489)	158 (518)
2 268 (5,000)	105 (345)	114 (374)	123 (403)	132 (432)	140 (460)	149 (489)	158 (518)
4 536 (10,000)	105 (345)	114 (374)	123 (403)	131 (430)	139 (456)	147 (481)	154 (506)
6 804 (15,000)	103 (337)	110 (361)	117 (385)	124 (408)	131 (430)	135 (442)	136 (446)
9 072 (20,000)	98 (322)	101 (332)	102 (336)	104 (340)	105 (344)	106 (348)	107 (352)
11 340 (25,000)	83 (272)	84 (276)	85 (280)	87 (284)	87 (287)	89 (291)	90 (295)
13 608 (30,000)	71 (234)	73 (238)	74 (242)	75 (246)	76 (250)	77 (254)	78 (257)

Wire rope lengths - single hoist drum 28 mm hoist line - boom No. 58 HL							
Boom length	Whip line - drum 2 or 3				Hoist line - drum 1		
	1 Part		2 Part				Maximum parts of line for full hoisting range
m (ft)	m	(ft)	m	(ft)	m	(ft)	
30,0 (98.4)	79	(260)	116	(380)	838	(2750)	26
36,0 (118.1)	91	(300)	134	(440)	853	(2800)	22
42,0 (137.8)	104	(340)	152	(500)	853	(2800)	18
48,0 (157.5)	116	(380)	171	(560)	930	(3050)	18
54,0 (177.2)	128	(420)	186	(610)	930	(3050)	14
60,0 (196.9)	140	(460)	204	(670)	930	(3050)	14
66,0 (216.5)	152	(500)	223	(730)	930	(3050)	12
72,0 (236.2)	165	(540)	241	(790)	930	(3050)	10
78,0 (255.9)	177	(580)	259	(850)	930	(3050)	10
84,0 (275.6)	189	(620)	277	(910)	930	(3050)	8
90,0 (295.3)	201	(660)	296	(970)	930	(3050)	6
96,0 (315.0)	213	(700)	314	(1030)	930	(3050)	6

Hoist reeving for main load block - single lead line 28 mm - boom No. 58 HL		
No. parts of line	Maximum load	
	kg	(lb)
2	32 520	71,700
4	65 090	143,500
6	97 610	215,200
8	130 180	287,000
10	162 750	358,800
12	195 270	430,500
14	227 840	502,300
16	260 360	574,000
18	292 930	645,800
20	322 690	711,400
22	351 530	775,000
24	379 840	837,400
26	400 000	881,900

NOTE: Hoist and whip line lengths given in table will allow hook to touch ground. When block travel below ground is required, add additional rope equal to parts of line times added travel distance. Hoisting distance or line pull may be limited when block travel below ground is required.

Performance data

Wire rope lengths - single hoist drum - 28 mm hoist line - boom No. 58 HL w/ 7 m (23 ft) extended upper boom point

Boom length m (ft)	Whip line drum 2 or 3 1 Part		Hoist line drum 1		Total parts of line
	m	(ft)	m	(ft)	
66,0 (216.5)	168	(550)	533	(1750)	6
72,0 (236.2)	180	(590)	579	(1900)	6
78,0 (255.9)	192	(630)	610	(2000)	6
84,0 (275.6)	204	(670)	655	(2150)	6
90,0 (295.3)	216	(710)	701	(2300)	6

NOTE: Hoist and whip line lengths given in table will allow hook to touch ground. When block travel below ground is required, add additional rope equal to parts of line times added travel distance. Hoisting distance or line pull may be limited when block travel below ground is required.

Wire rope lengths - single hoist drum - 28 mm hoist line boom No. 58 HL w/ 30,0 m (98.4 ft) mast No. 59A and 7,0 m (23.0 ft) extended upper boom point

Boom length m (ft)	Whip line drum 2 or 3 1 Part		Hoist line drum 1		Total parts of line
	m	(ft)	m	(ft)	
96,0 (315.0)	229	(750)	747	(2450)	6

NOTE: Hoist and whip line lengths given in table will allow hook to touch ground. When block travel below ground is required, add additional rope equal to parts of line times added travel distance. Hoisting distance or line pull may be limited when block travel below ground is required.

Wire rope lengths - single hoist drum - 28mm hoist line boom No. 58 WA with 7.6 m (25 ft) extended upper boom point

Boom length m (ft)	Whip line - drum 2 or 3				Hoist line - drum 1		Total parts of line
	1 Part		2 Part		m	(ft)	
	m	(ft)	m	(ft)			
65 (213.3)	183	(600)	244	(800)	686	(2250)	8
68 (223.1)	183	(600)	259	(850)	701	(2300)	8
71 (232.9)	183	(600)	274	(900)	732	(2400)	8
74 (242.8)	198	(650)	274	(900)	762	(2500)	8
77 (252.6)	198	(650)	290	(950)	792	(2600)	8
80 (262.5)	198	(650)	290	(950)	808	(2650)	8
83 (272.3)	213	(700)	305	(1000)	838	(2750)	8
86 (282.2)	213	(700)	320	(1050)	869	(2850)	8
89 (292.0)	229	(750)	320	(1050)	899	(2950)	8
92 (301.8)	-	-	-	-	914	(3000)	8

Hoist reeving for main load block single lead line - 28 mm boom No. 58 HL w/ 7 m (23 ft) extended upper boom point

No. parts of line	Maximum load	
	kg	(lb)
2	32 520	71,700
4	65 090	143,500
6	97 600	215,200

Hoist reeving for main load block single lead line - 28 mm boom No. 58 HL w/ 30,0 m (98.4 ft) mast No. 59A and 7,0 m (23.0 ft) extended upper boom point

No. parts of line	Maximum load	
	kg	(lb)
2	32 520	71,700
4	65 090	143,500
6	81 500	179,800

Hoist reeving for main load block single lead line - 28 mm boom No. 58 WA w/ 7.6 m (25 ft) extended upper boom point

No. parts of line	Maximum load	
	kg	(lb)
2	32 520	71,700
4	65 090	143,500
6	97 610	215,200
8	130 000	296,600

Performance data

Wire rope lengths - single hoist drum - 28 mm hoist line - luffing jib No. 59 on boom No. 58 HL

Boom length m (ft)	Hoist line drum 1		Whip line drum 2			
			1 Part		2 Part	
	m	(ft)	m	(ft)	m	(ft)
30,0 (98.4)	747	(2450)	244	(800)	366	(1200)
36,0 (118.1)	808	(2650)	259	(850)	381	(1250)
42,0 (137.8)	808	(2650)	274	(900)	396	(1300)
48,0 (157.5)	823	(2700)	290	(950)	427	(1400)
54,0 (177.2)	823	(2700)	305	(1000)	442	(1450)
60,0 (196.9)	823	(2700)	305	(1000)	442	(1450)
66,0 (216.5)	823	(2700)	305	(1000)	422	(1450)

Hoist reeving for main load block single lead line - luffing jib No. 59 on boom No. 58 HL 28 mm

No. parts of line	Maximum load	
	kg	(lb)
2	32 520	71,700
4	65 090	143,500
6	97 610	215,200
8	130 180	287,000
10	162 750	358,800
12	185 200	408,500

NOTE: Hoist line lengths given in table include all luffing jib lengths. Hoist and whip line lengths given in table will allow hook to touch ground. When block travel below ground is required, add additional rope equal to parts of line times added travel distance. Hoisting distance or line pull may be limited when block travel below ground is required.

Maximum required parts of line - luffing jib No. 59 on boom No. 58 HL

Boom length m (ft)	Maximum parts of line										
	Jib length m (ft)										
	24,0 (78.7)	30,0 (98.4)	36,0 (118.1)	42,0 (137.8)	48,0 (157.5)	54,0 (177.2)	60,0 (196.9)	66,0 (216.5)	72,0 (236.2)	78,0 (255.9)	84,0 (275.6)
30,0 (98.4)	12	10	10	8	8	6	6	6	4	4	4
36,0 (118.1)	12	10	10	8	8	6	6	6	4	4	4
42,0 (137.8)	10	10	8	8	6	6	6	4	4	4	4
48,0 (157.5)	10	8	8	8	6	6	6	4	4	4	4
54,0 (177.2)	8	8	6	6	6	6	4	4	4	4	2
60,0 (196.9)	8	8	6	6	6	4	4	—	—	—	—
66,0 (216.5)	8	6	—	—	—	—	—	—	—	—	—

Performance data

Wire rope lengths - single hoist line drum - 28 mm boom No. 58 HL 16000 MAX-ER							
Boom length m (ft)	Whip line - drum 2 or 3				Hoist line - drum 1		
	1 Part		2 Part				Total parts of line
	m	(ft)	m	(ft)	m	(ft)	
42,0 (137.8)	107	(350)	152	(500)	1 082	(3550)	24
48,0 (157.5)	119	(390)	171	(560)	1 128	(3700)	22
54,0 (177.2)	131	(430)	189	(620)	1 158	(3800)	20
60,0 (196.9)	143	(470)	207	(680)	1 158	(3800)	18
66,0 (216.5)	155	(510)	226	(740)	1 158	(3800)	16
72,0 (236.2)	168	(550)	244	(800)	1 158	(3800)	14
78,0 (255.9)	177	(580)	262	(860)	1 189	(3900)	14
84,0 (275.6)	189	(620)	277	(910)	1 189	(3900)	12
90,0 (295.3)	201	(660)	296	(970)	1 189	(3900)	10
96,0 (315.0)	213	(700)	314	(1030)	1 189	(3900)	8
102,0 (334.6)	226	(740)	332	(1090)	1 189	(3900)	8
108,0 (354.3)	238	(780)	351	(1150)	1 189	(3900)	6
114,0 (374.0)	250	(820)	369	(1210)	1 189	(3900)	6
120,0 (393.7)	262	(860)	387	(1270)	1 189	(3900)	6

Hoist reeving for main load block - single lead line - 28 mm boom No. 58 HL 16000 MAX-ER		
No. parts of line	Maximum load	
	kg	(lb)
2	32 520	71,700
4	65 090	143,500
6	97 610	215,200
8	130 180	287,000
10	162 750	358,800
12	195 270	430,500
14	227 840	502,300
16	260 360	574,000
18	292 930	645,800
20	322 690	711,400
22	351 530	775,000
24	379 800	837,400

NOTE: Hoist and whip line lengths given in table will allow hook to touch ground. When block travel below ground is required, add additional rope equal to parts of line times added travel distance. Hoisting distance or line pull may be limited when block travel below ground is required.

Boom combinations

ANSI B30.5

No. 58 main boom with heavy-lift top combinations

Boom length m (ft)	Boom inserts m (ft)			
	5,0* (16.4)	6,0 (19.7)	12,0 (39.4)	12,0** (39.4)
30 (98.4)	1	0	0	1
36 (118.1)	1	1	0	1
42 (137.8)	1	0	1	1
48 (157.5)	1	1	1	1
54 (177.2)	1	0	2	1
60 (196.9)	1	1	2	1
66 (216.5)	1	0	3	1
72 (236.2)	1	1	3	1
78 (255.9)	1	0	4	1
84 (275.6)	1	1	4	1
90 (295.3)	1	0	5	1
96 (315.0)	1	1	5	1

*transition boom insert.
**with auxiliary sheave insert.

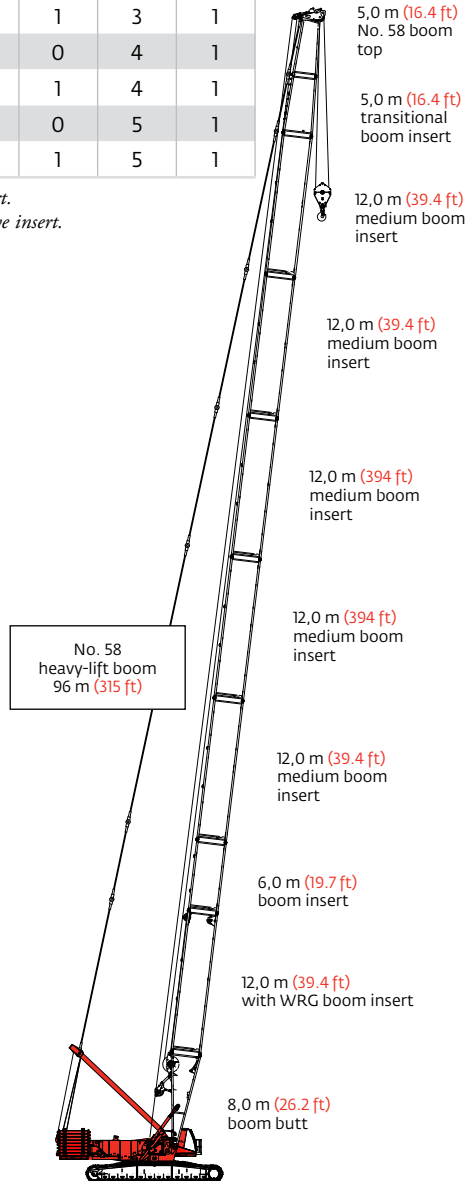

Model 16000
No. 58 heavy-lift main boom
96 m (315 ft)

No. 58 main boom with 97.6 t (107.6 USt) extended upper boom point combinations

Boom length m (ft)	Boom inserts m (ft)			
	5,0* (16.4)	6,0 (19.7)	12,0 (39.4)	12,0** (39.4)
30 (98.4)	1	0	0	1
36 (118.1)	1	1	0	1
42 (137.8)	1	0	1	1
48 (157.5)	1	1	1	1
54 (177.2)	1	0	2	1
60 (196.9)	1	1	2	1
66 (216.5)	1	0	3	1
72 (236.2)	1	1	3	1
78 (255.9)	1	0	4	1
84 (275.6)	1	1	4	1
90 (295.3)	1	0	5	1

*transition boom insert.
**with auxiliary sheave insert.

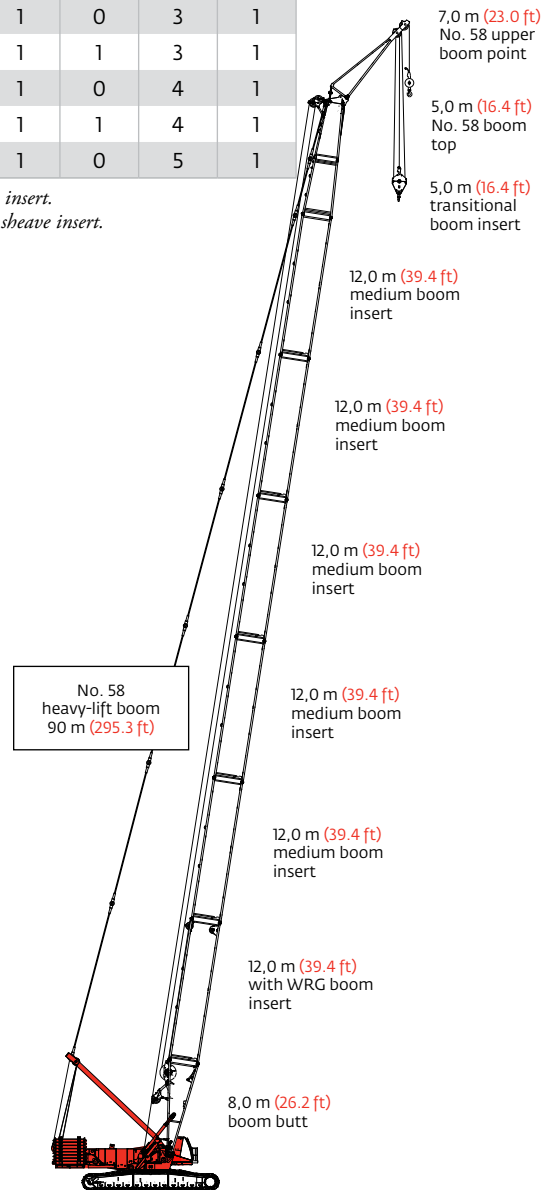

Model 16000
No. 58 heavy-lift main boom with
extended upper boom 90 m (295.3 ft)

Boom combinations

ANSI B30.5

No. 58 WA boom with 129.9 t (143.2 USt) extended upper boom point combinations

Boom length m (ft)	Boom inserts m (ft)				
	5,0* (16.4)	6,0 (19.7)	12,0 (39.4)	12,0 (39.4)	12,0** (39.4)
65 (213.3)	1	1	0	3	1
68 (223.1)	1	0	1	3	1
71 (232.9)	1	1	0	3	1
74 (242.8)	1	0	1	4	1
77 (252.6)	1	1	0	4	1
80 (262.5)	1	0	1	4	1
83 (272.3)	1	1	0	4	1
86 (282.2)	1	0	1	5	1
89 (292.0)	1	1	0	5	1
92 (301.8)	1	0	1	5	1

*transition boom insert.

**with auxiliary sheave insert.

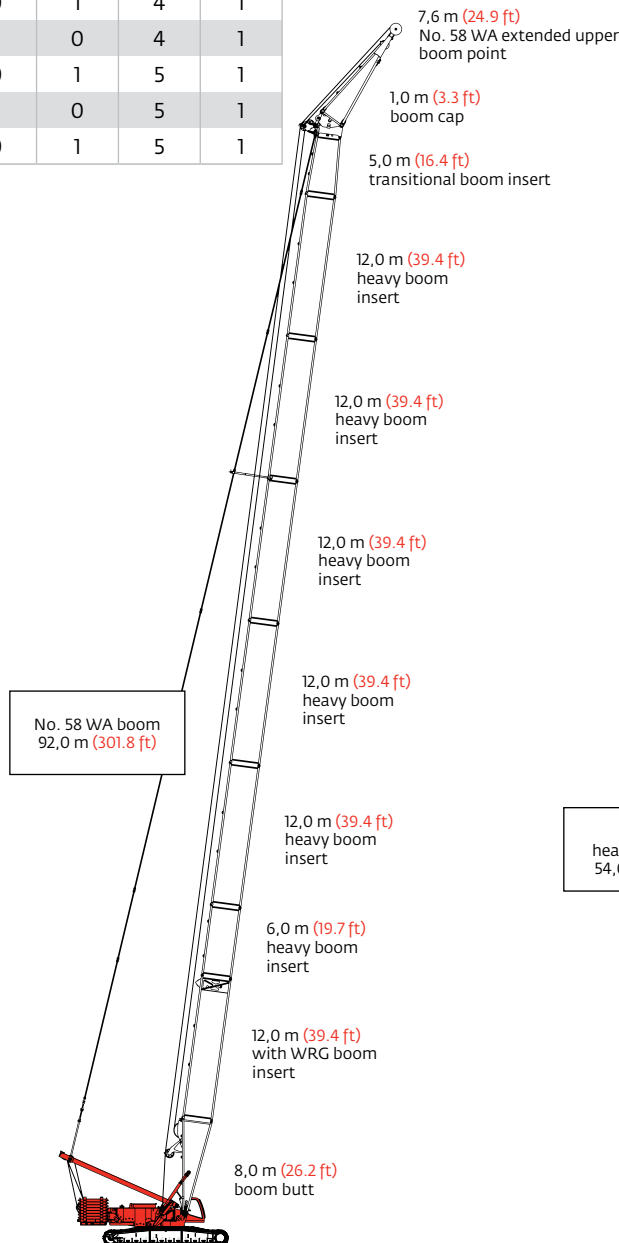

Model 16000
No. 58 WA boom 92,0 m (301.8 ft)

No. 59 luffing jib combinations

Luffing jib length m (ft)	Luffing jib inserts m (ft)	
	6,0 (19.7)	12,0 (39.4)
24 (78.7)	1	0
30 (98.4)	0	1
36 (118.1)	1	1
42 (137.8)	0	2
48 (157.5)	1	2
54 (177.2)	0	3
60 (196.9)	1	3
66 (216.5)	0	4
72 (236.2)	1	4
78 (255.9)	0	5
84 (275.6)	1	5

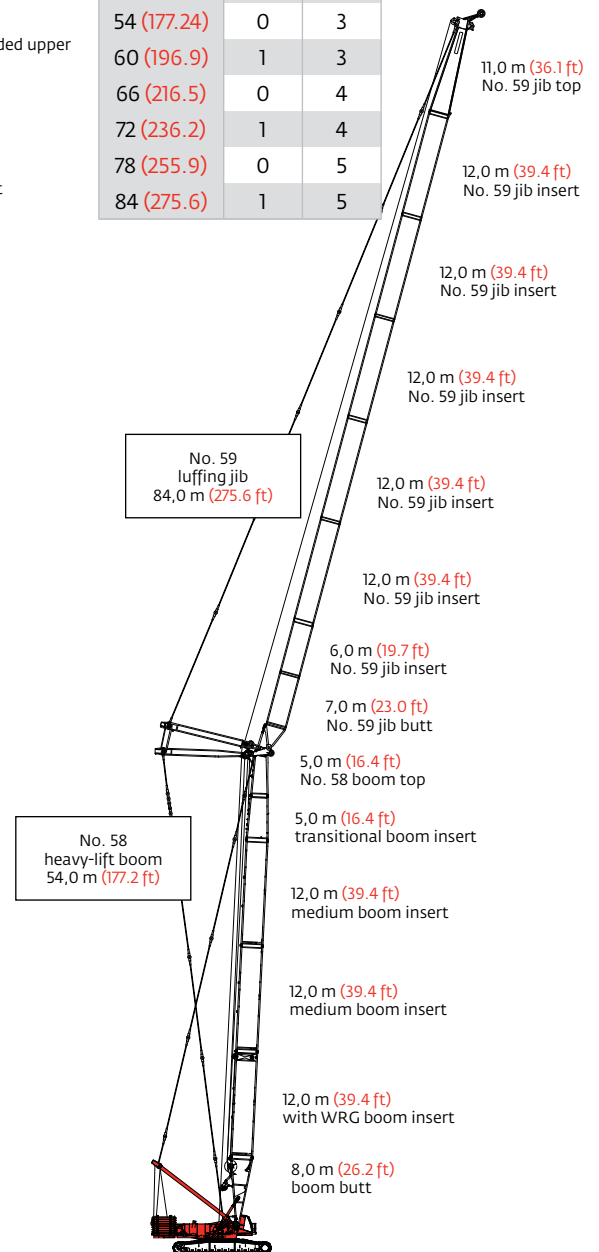

Model 16000
No. 59 luffing jib on
No. 58 heavy-lift main boom
132 m (433.1 ft)

Heavy-lift boom load charts

ANSI B30.5

Liftcrane boom capacities - Model 16000 Series 3												
No. 58 heavy-lift main boom												
Boom m (ft) Radius	150 590 kg (332,000 lb) Counterweight						54 430 kg (120,000 lb) Carbody counterweight					
	360° Rating kg (lb) x 1 000											
	30,0 (98.4)	36,0 (118.1)	42,0 (137.8)	48,0 (157.5)	54,0 (177.2)	60,0 (196.9)	66,0 (216.5)	72,0 (236.2)	78,0 (255.9)	84,0 (275.6)	90,0 (295.3)	96,0 (315.0)
6,4 (21)	400,0 (881.9)											
8,0 (26)	323,8 (720.5)	323,3 (719.3)	283,4 (625.7)									
10,0 (32)	256,4 (581.7)	256,1 (581.0)	256,6 (580.8)	257,2 (579.6)	216,1 (483.0)							
12,0 (40)	194,8 (419.1)	195,1 (419.7)	195,5 (420.5)	195,4 (420.4)	193,2 (420.4)	181,9 (397.4)	159,6 (348.9)	147,0 (321.3)	— (302.9)			
14,0 (45)	153,7 (349.9)	153,9 (350.3)	154,2 (351.0)	154,1 (350.7)	154,0 (350.6)	154,5 (350.0)	145,6 (325.9)	134,0 (299.5)	129,7 (288.7)	113,7 (252.0)	95,5 (211.6)	
18,0 (60)	106,3 (229.3)	106,4 (229.5)	106,6 (229.9)	106,3 (229.3)	106,2 (229.0)	105,8 (228.1)	105,5 (227.5)	105,7 (226.4)	105,4 (225.6)	103,4 (224.5)	89,4 (196.3)	77,2 (169.5)
22,0 (70)	79,6 (183.6)	79,7 (183.8)	79,9 (184.2)	79,5 (183.4)	79,4 (183.1)	78,9 (182.0)	78,5 (181.3)	78,0 (180.2)	77,6 (179.2)	77,0 (178.0)	76,8 (176.9)	72,5 (161.6)
26,0 (85)	62,4 (138.5)	62,5 (138.7)	62,7 (139.1)	62,4 (138.3)	62,1 (137.8)	61,6 (136.7)	61,3 (135.9)	60,7 (134.6)	60,2 (133.5)	59,6 (132.2)	59,0 (131.0)	58,4 (129.6)
30,0 (100)	50,3 (108.2)	50,5 (108.9)	50,7 (109.3)	50,3 (108.5)	50,1 (108.0)	49,6 (106.8)	49,2 (106.0)	48,6 (104.6)	48,1 (103.5)	47,5 (102.1)	46,9 (100.9)	46,2 (99.4)
34,0 (110)		41,6 (93.9)	41,9 (94.5)	41,5 (93.7)	41,3 (93.2)	40,8 (92.0)	40,3 (91.1)	39,8 (89.8)	39,2 (88.6)	38,5 (87.1)	38,0 (85.9)	37,3 (84.4)
38,0 (120)		— (81.5)	35,0 (82.3)	34,7 (81.6)	34,5 (81.1)	33,9 (79.9)	33,6 (79.0)	32,9 (77.6)	32,4 (76.4)	31,7 (74.9)	31,1 (73.7)	30,4 (72.1)
40,0 (130)			32,1 (72.1)	31,9 (71.5)	31,7 (71.1)	31,1 (69.8)	30,7 (69.0)	30,1 (67.5)	29,5 (66.3)	28,8 (64.8)	28,3 (63.6)	27,6 (62.0)
44,0 (140)				27,0 (62.9)	26,8 (62.5)	26,2 (61.3)	25,9 (60.5)	25,2 (59.0)	24,7 (57.8)	24,0 (56.3)	23,4 (55.0)	22,7 (53.4)
48,0 (155)				— (52.1)	22,8 (52.0)	22,3 (50.8)	21,9 (49.9)	21,2 (48.5)	20,7 (47.2)	20,0 (45.7)	19,4 (44.5)	18,7 (42.8)
52,0 (170)					19,4 (43.2)	18,9 (42.2)	18,5 (41.3)	17,9 (39.9)	17,4 (38.7)	16,6 (37.1)	16,1 (35.9)	15,3 (34.2)
56,0 (180)						16,1 (37.2)	15,7 (36.5)	15,1 (35.0)	14,5 (33.8)	13,8 (32.2)	13,3 (31.0)	12,5 (29.3)
60,0 (195)						— (30.7)	13,3 (30.1)	12,6 (28.7)	12,1 (27.5)	11,4 (25.9)	10,8 (24.7)	10,1 (23.0)
64,0 (210)							11,1 (24.6)	10,5 (23.3)	10,0 (22.1)	9,3 (20.5)	8,7 (19.3)	7,9 (17.6)
68,0 (220)								8,6 (20.0)	8,1 (18.9)	7,4 (17.3)	6,8 (16.1)	6,1 (14.5)
70,0 (230)								7,7 (17.1)	7,2 (16.0)	6,5 (14.4)	6,0 (13.2)	5,3 (11.6)
76,0 (255)									4,9 (—)	4,2 (8.1)	3,7 (7.0)	

Extended upper boom point range diagram

ANSI B30.5

Liftcrane boom capacities - Model 16000 Series 3
 No. 58 heavy-lift main boom with extended upper boom point 7 m (23 ft)

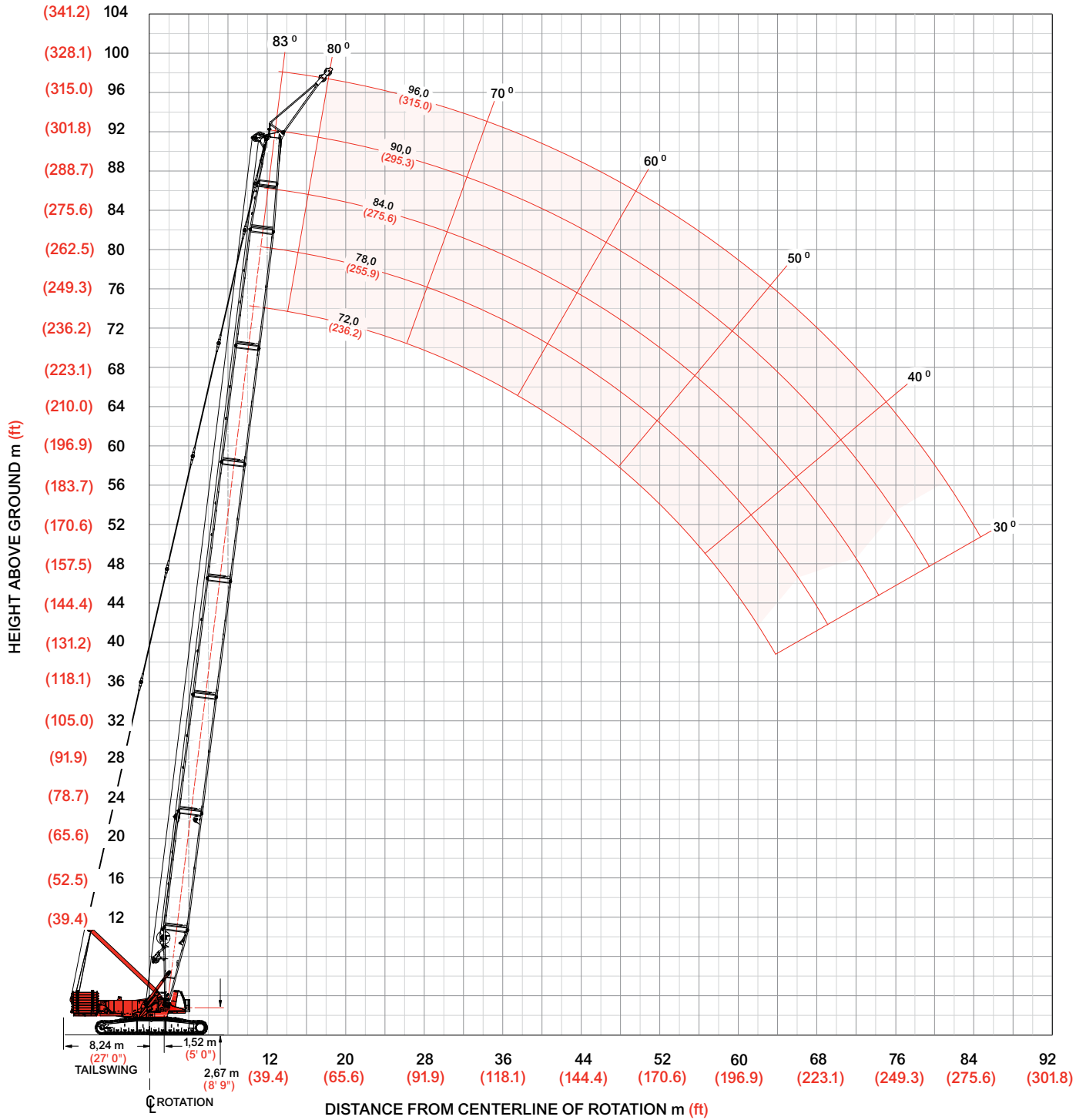

Extended upper boom point load charts

ANSI B30.5

Liftcrane boom capacities - Model 16000 No. 58 heavy-lift main boom with 7,0 m (23 ft) extended upper boom point					
Boom m (ft) Radius	150 590 kg (332,000 lb) Counterweight 54 430 kg (120,000 lb) Carbody counterweight 360° Rating kg (lb) x1000				
	66,0 (216.5)	72,0 (236.2)	78,0 (255.9)	84,0 (275.6)	90,0 (295.3)
15,2 (50)	97,6 (215.2)				
16,8 (55)	97,6 (215.2)	97,6 (215.2)	91,3 (201.5)	87,8 (193.7)	
18,0 (60)	97,6 (215.2)	97,6 (215.2)	89,6 (196.8)	86,5 (190.1)	
20,0 (65)	95,5 (212.3)	95,1 (211.5)	87,1 (192.6)	84,4 (186.6)	74,6 (165.0)
22,0 (75)	82,7 (172.6)	82,3 (171.7)	82,7 (170.8)	81,1 (169.8)	72,5 (158.2)
24,0 (80)	72,9 (157.2)	72,4 (156.1)	72,0 (155.2)	71,8 (154.2)	70,1 (153.2)
26,0 (90)	64,8 (132.2)	64,4 (131.1)	63,9 (130.1)	63,4 (128.9)	63,0 (127.9)
28,0 (95)	58,1 (122.0)	57,6 (120.8)	57,1 (119.8)	56,6 (118.6)	56,1 (117.5)
30,0 (100)	52,4 (112.9)	51,9 (111.7)	51,4 (110.7)	50,8 (109.4)	50,3 (108.3)
32,0 (105)	45,5 (104.9)	47,0 (103.6)	46,5 (102.5)	45,9 (101.3)	45,4 (100.2)
34,0 (115)	43,3 (91.0)	42,7 (89.7)	42,2 (88.6)	41,6 (87.3)	41,1 (86.2)
38,0 (125)	36,2 (79.6)	35,6 (78.3)	35,1 (77.2)	34,5 (75.8)	33,9 (74.6)
40,0 (135)	33,3 (70.1)	32,7 (68.7)	32,2 (67.6)	31,5 (66.2)	31,0 (65.0)
44,0 (145)	28,3 (62.0)	27,7 (60.6)	27,1 (59.4)	26,5 (58.0)	25,9 (56.8)
48,0 (160)	24,2 (51.8)	23,5 (50.4)	23,0 (49.2)	22,3 (47.7)	21,8 (46.5)
52,0 (175)	20,7 (43.5)	20,1 (42.1)	19,5 (40.8)	18,9 (39.4)	18,3 (38.2)
56,0 (185)	17,8 (38.7)	17,1 (37.3)	16,6 (36.1)	15,9 (34.6)	15,4 (33.4)
60,0 (200)	15,2 (32.4)	14,6 (31.1)	14,0 (29.8)	13,4 (28.4)	12,8 (27.1)
64,0 (210)		12,4 (27.4)	11,8 (26.2)	11,2 (24.7)	10,6 (23.5)
68,0 (225)			9,9 (21.3)	9,2 (19.8)	8,7 (18.7)
72,0 (240)			8,1 (17.1)	7,5 (15.6)	7,0 (14.4)
76,0 (250)				5,9 (13.0)	5,4 (11.9)
82,0 (270)					3,4 (7.4)

Extended upper boom point range diagram

ANSI B30.5

Liftcrane boom capacities - Model 16000 Wind Attachment
 No. 58 Wind Attachment with 7,6 m (25 ft) extended upper boom point

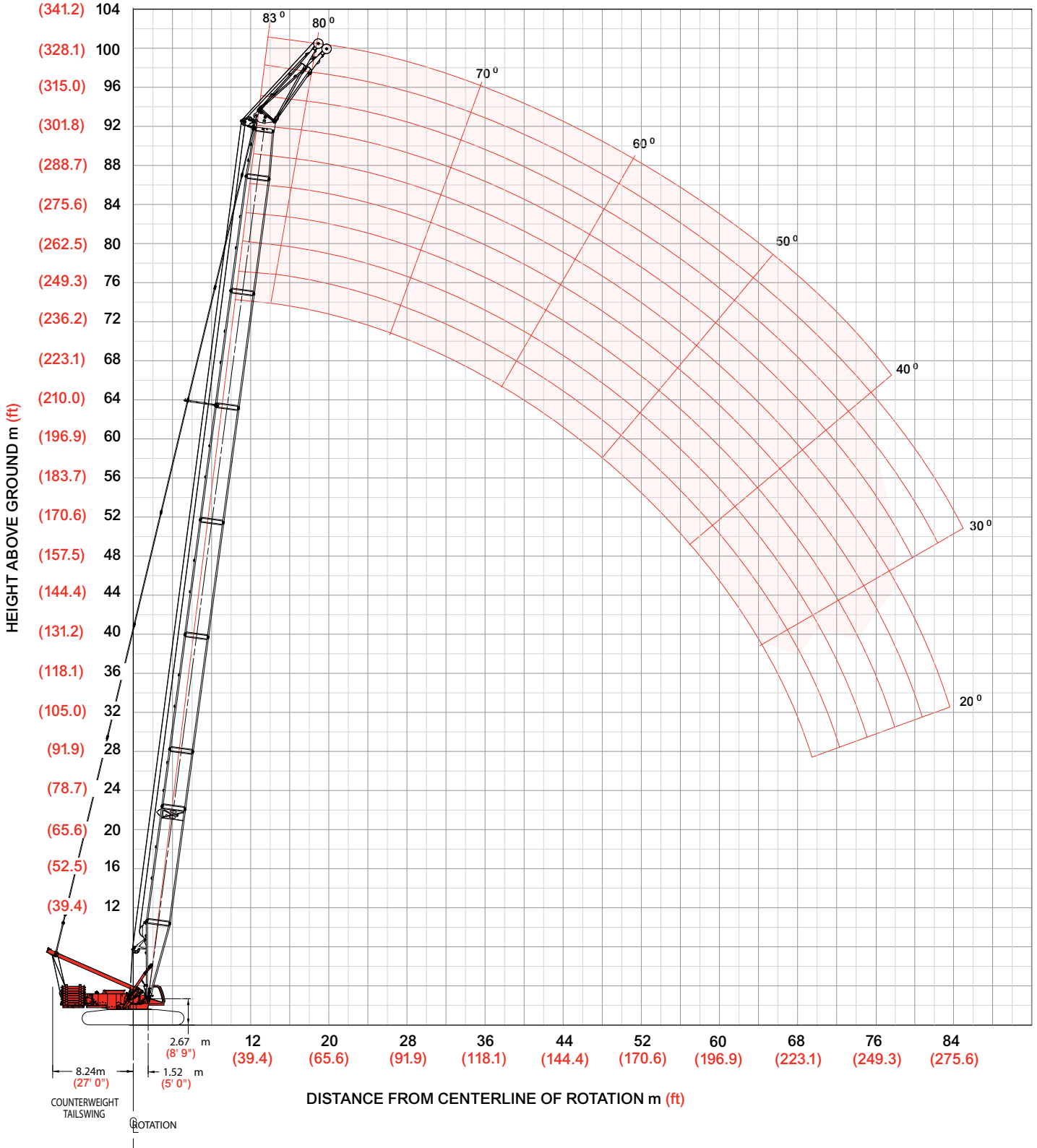

Luffing jib range diagram

ANSI B30.5

Liftcrane boom capacities - Model 16000 Series 3
No. 58 heavy-lift main boom with No. 59 luffing jib

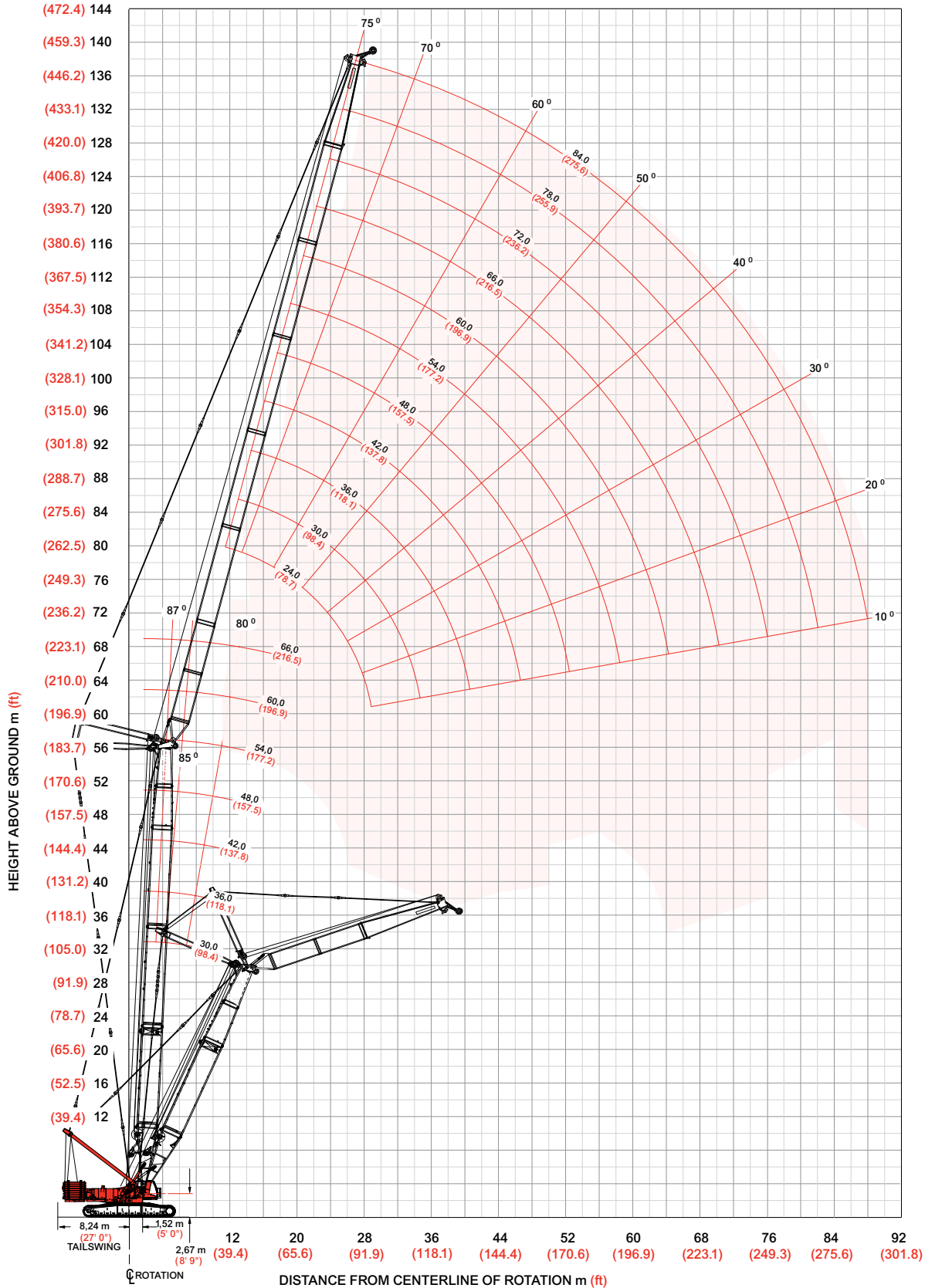

Luffing jib load charts

ANSI B30.5

Liftcrane boom capacities - Model 16000 Series 3 No. 59 Luffing Jib on No. 58 heavy-lift main boom

150 590 kg (332,000 lb) Counterweight 54 430 kg (120,000 lb) Carbody counterweight
360° Rating kg (lb) x1 000

87° Boom angle

Luffing jib length 24,0 m (78.7 ft)	Boom m (ft) Radius	30,0 (98.4)	42,0 (137.8)	54,0 (177.2)	66,0 (216.5)	Luffing jib length 36,0 m (118.1 ft)	Boom m (ft) Radius	30,0 (98.4)	42,0 (137.8)	54,0 (177.2)	60,0 (196.9)	Luffing jib length 48,0 m (157.5 ft)	Boom m (ft) Radius	30,0 (98.4)	42,0 (137.8)	54,0 (177.2)	60,0 (196.9)
	11,6 (38)	185,2 (408.5)						15,2 (50)	136,1 (300.2)	116,8 (252.6)					18,3 (60)	107,4 (236.8)	92,1 (203.2)
14,0 (45)	157,7 (354.2)	151,0 (333.0)	117,4 (262.3)	99,6 (222.2)		16,0 (55)	131,2 (278.3)	113,3 (242.0)	—	—		22,0 (75)	91,9 (191.9)	81,6 (175.1)	70,3 (151.1)	66,6 (142.9)	
18,0 (60)	121,1 (260.7)	112,6 (244.8)	97,8 (213.0)	84,8 (184.8)		18,0 (60)	118,9 (258.6)	104,3 (227.5)	89,0 (194.3)	84,5 (184.4)		24,0 (80)	81,6 (176.5)	75,6 (166.8)	66,2 (144.3)	62,6 (136.6)	
22,0 (75)	92,7 (194.7)	92,7 (194.5)	82,2 (174.9)	72,3 (154.3)		22,0 (75)	92,3 (193.7)	89,1 (190.3)	77,1 (165.1)	73,3 (157.0)		30,0 (100)	61,2 (132.2)	61,0 (131.8)	55,5 (120.9)	52,6 (114.6)	
26,0 (90)	74,6 (147.9)	73,9 (147.8)	69,5 (144.3)	62,1 (129.5)		26,0 (90)	74,4 (153.3)	74,3 (152.9)	67,1 (141.2)	64,0 (134.6)		34,0 (115)	52,0 (110.2)	51,8 (109.9)	49,5 (106.2)	47,0 (100.7)	
32,0 (105)						32,0 (105)	57,0 (125.8)	56,9 (125.5)	55,2 (121.7)	52,5 (115.8)		38,0 (125)	44,9 (98.8)	44,8 (98.6)	44,4 (97.7)	42,0 (92.5)	
38,0 (125)						38,0 (125)	45,6 (100.2)	45,5 (100.0)	44,8 (98.5)	43,0 (94.7)		42,0 (140)	39,3 (85.0)	39,2 (84.8)	39,1 (84.4)	37,6 (81.5)	
44,0 (145)						44,0 (145)						46,0 (155)	34,8 (74.0)	34,7 (73.8)	34,5 (73.4)	33,7 (71.7)	
52,0 (175)						52,0 (175)						52,0 (175)				27,0 (54.3)	
56,0 (185)						56,0 (185)						56,0 (185)					
60,0 (195)						60,0 (195)						60,0 (195)					

Luffing jib length 60,0 m (196.9 ft)	Boom m (ft) Radius	30,0 (98.4)	42,0 (137.8)	54,0 (177.2)	60,0 (196.9)
	21,3 (70)	86,0 (189.7)	73,5 (162.2)		
24,0 (80)	79,1 (172.5)	69,3 (151.1)	58,2 (128.1)	51,8 (114.1)	
28,0 (95)	65,9 (139.2)	62,1 (133.6)	53,2 (114.7)	49,6 (107.3)	
34,0 (115)	51,1 (108.2)	50,9 (107.8)	45,8 (98.3)	43,2 (92.8)	
40,0 (135)	41,1 (87.2)	40,9 (86.9)	39,4 (84.4)	37,2 (79.7)	
48,0 (160)	31,9 (69.0)	31,8 (68.7)	31,7 (68.3)	30,4 (65.9)	
56,0 (185)	25,6 (55.9)	25,5 (55.7)	25,3 (55.3)	24,9 (54.4)	
64,0 (210)	18,4 (40.7)	18,3 (40.5)	18,2 (40.3)	18,1 (40.1)	
72,0 (240)					
84,0 (280)					
88,0 (290)					

Luffing jib length 72,0 m (236.2 ft)	Boom m (ft) Radius	30,0 (98.4)	42,0 (137.8)	54,0 (177.2)
	21,3 (70)			
24,0 (80)	— (132.1)	— (115.1)		
28,0 (95)	58,3 (127.7)	51,2 (112.4)	43,1 (94.6)	
34,0 (115)	49,9 (105.8)	48,2 (103.7)	40,6 (88.0)	
40,0 (135)	40,0 (84.8)	39,8 (84.5)	36,3 (78.1)	
48,0 (160)	30,9 (66.6)	30,7 (66.3)	30,3 (65.7)	
56,0 (185)	24,5 (53.5)	24,4 (53.3)	24,2 (52.9)	
64,0 (210)	19,8 (43.7)	19,7 (43.5)	19,5 (43.2)	
72,0 (240)	16,1 (34.6)	15,7 (32.5)	15,2 (31.6)	
84,0 (280)				
88,0 (290)				

Luffing jib length 84,0 m (275.6 ft)	Boom m (ft) Radius	30,0 (98.4)	42,0 (137.8)	54,0 (177.2)
	21,3 (70)			
24,0 (80)				
28,0 (95)	42,6 (93.3)	37,9 (83.3)	— (70.9)	
34,0 (115)	40,7 (89.2)	36,7 (80.5)	31,4 (68.9)	
40,0 (135)	38,7 (82.5)	35,4 (77.7)	30,0 (65.2)	
48,0 (160)	29,8 (64.2)	29,6 (63.9)	26,4 (57.4)	
56,0 (185)	23,4 (51.2)	23,3 (50.9)	22,7 (49.8)	
64,0 (210)	18,8 (41.5)	18,6 (41.2)	18,5 (40.9)	
72,0 (240)	15,2 (32.5)	15,1 (32.3)	14,9 (32.0)	
84,0 (280)	10,6 (21.4)	9,6 (19.5)	9,1 (18.4)	
88,0 (290)		6,8 (14.2)	6,6 (14.0)	

Luffing jib load charts

ANSI B30.5

Liftcrane boom capacities - Model 16000 Series 3 No. 59 luffing jib on No. 58 heavy-lift main boom

150 590 kg (332,000 lb) Counterweight 54 430 kg (120,000 lb) Carbody counterweight
360° Rating kg (lb) x 1 000

65° Boom angle

Luffing jib length 24,0 m (78.7 ft)	Boom m (ft) Radius				Luffing jib length 36,0 m (118.1 ft)	Boom m (ft) Radius				Luffing jib length 48,0 m (157.5 ft)	Boom m (ft) Radius		
	30,0 (98.4)	42,0 (137.8)	54,0 (177.2)	66,0 (216.5)		30,0 (98.4)	42,0 (137.8)	54,0 (177.2)	60,0 (196.9)		30,0 (98.4)	42,0 (137.8)	54,0 (177.2)
32,0 (105)	47,9 (105.7)				32,0 (105)					32,0 (105)			
36,0 (120)	41,0 (88.7)	— (80.8)			36,0 (120)					36,0 (120)			
40,0 (135)	61,9 —	32,4 (68.9)			40,0 (135)	34,8 (74.0)				40,0 (135)			
44,0 (145)		28,2 (61.9)	25,0 (60.6)		44,0 (145)	30,6 (67.1)	27,4 (60.1)			44,0 (145)			
48,0 (160)			21,9 (47.2)	18,5 (39.8)	48,0 (160)	27,0 (58.4)	24,2 (52.2)	— (44.9)		48,0 (160)	26,0 (56.1)		
52,0 (175)				16,2 (34.3)	52,0 (175)		21,5 (45.7)	18,4 (39.2)	16,6 (35.4)	52,0 (175)	23,1 (49.2)	20,3 (43.1)	
56,0 (185)					54,0 (180)		20,3 (43.7)	17,4 (34.3)	15,7 (33.8)	54,0 (180)	21,9 (47.1)	19,1 (41.2)	
60,0 (200)					60,0 (200)			14,6 (31.2)	13,1 (28.2)	60,0 (200)	18,5 (39.9)	16,2 (34.8)	13,3 (28.7)
62,0 (205)					62,0 (205)				12,3 (26.9)	62,0 (205)	17,5 (38.2)	15,3 (33.3)	12,6 (27.5)
68,0 (225)					68,0 (225)					68,0 (225)			10,6 (23.0)
72,0 (240)					72,0 (240)					72,0 (240)			9,3 (19.8)

Luffing jib length 60,0 m (196.9 ft)	Boom m (ft) Radius	
	30,0 (98.4)	42,0 (137.8)
54,0 (180)	20,6 (44.5)	
56,0 (185)	19,5 (42.6)	
58,0 (190)	18,4 (40.8)	15,7 (34.9)
60,0 (200)	17,4 (37.5)	14,8 (31.9)
64,0 (210)	15,6 (34.5)	13,2 (29.3)
68,0 (225)	14,0 (30.5)	11,8 (25.7)
72,0 (240)	12,6 (26.9)	10,5 (22.5)
74,0 (245)	11,8 (25.7)	9,9 (21.5)
76,0 (250)		9,3 (20.6)
80,0 (260)		— (18.7)
84,0 (280)		

Luffing jib length 72,0 m (236.2 ft)	Boom m (ft) Radius
	30,0 (98.4)
54,0 (180)	
56,0 (185)	
58,0 (190)	
60,0 (200)	16,1 (34.5)
64,0 (210)	14,3 (31.6)
68,0 (225)	12,7 (27.7)
72,0 (240)	11,3 (24.3)
74,0 (245)	10,7 (23.2)
76,0 (250)	10,1 (22.2)
80,0 (260)	9,0 (20.3)
84,0 (280)	7,9 (16.8)

Outline dimensions

MAX-ER®

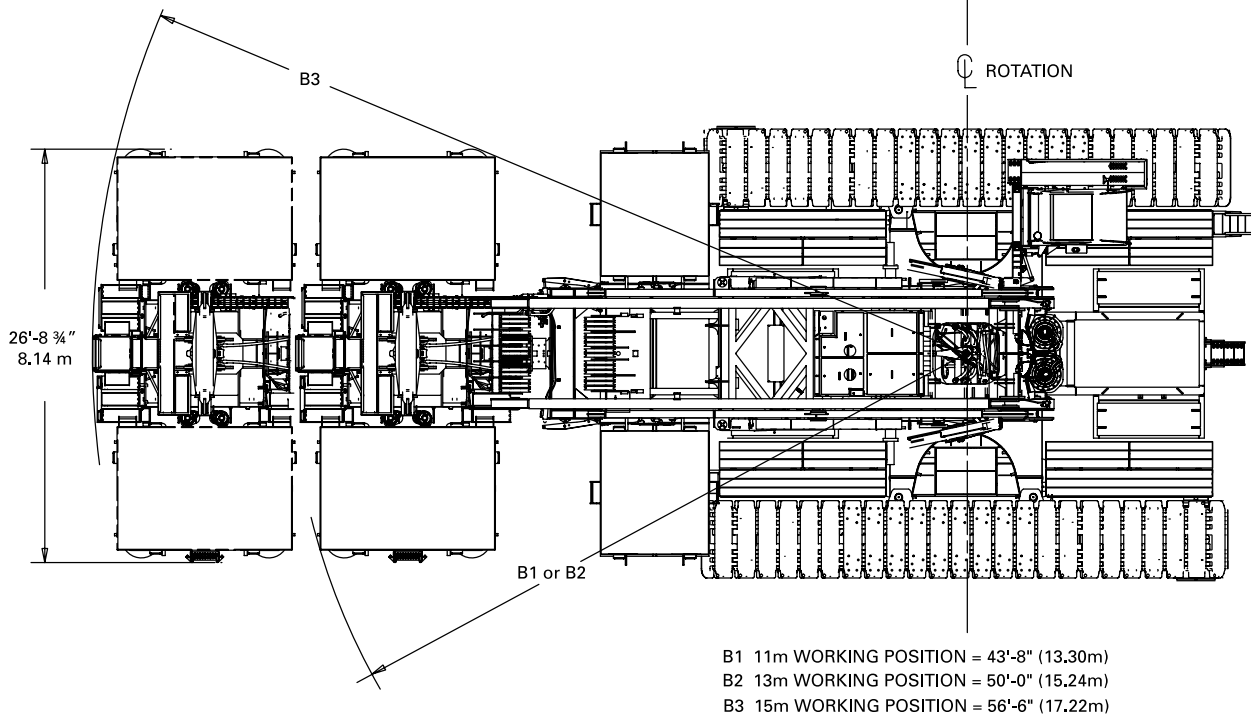
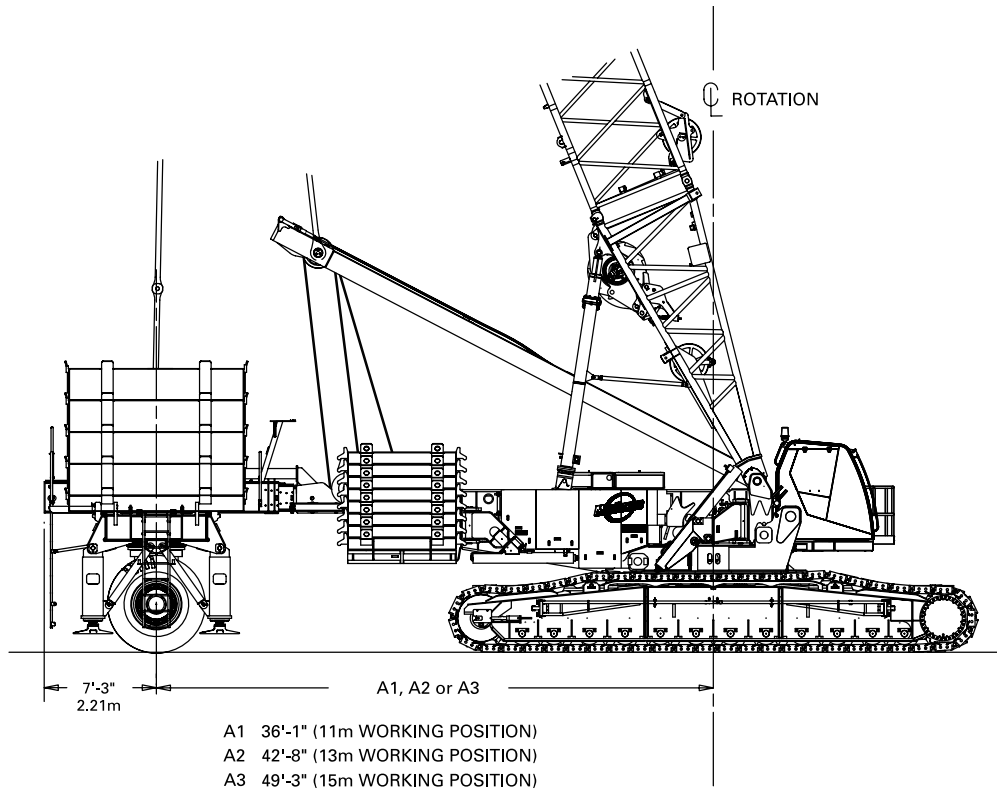

Outline dimensions

MAX-ER®

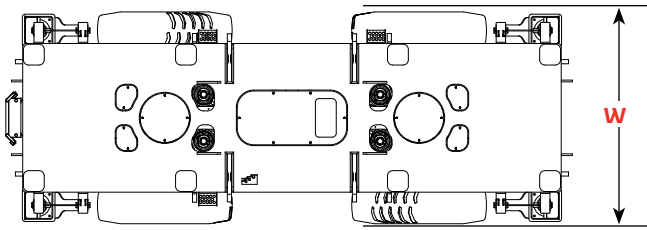

Wheeled carrier (US)

Length	8,15 m	26' 9"
Width	3,05 m	10' 0"
Height	3,00 m	9' 10"
Weight	28 304 kg	62,400 lb

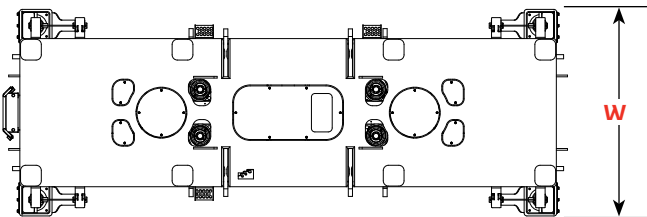
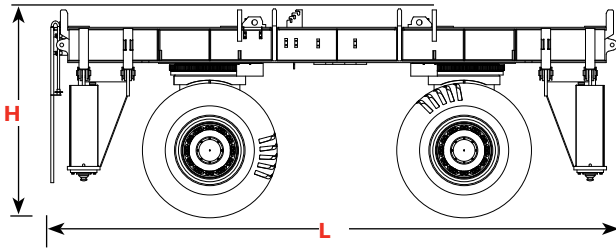

Wheeled carrier (European)

Length	8,15 m	26' 9"
Width	2,98 m	9' 9"
Height	3,00 m	9' 10"
Weight	28 622 kg	63,100 lb

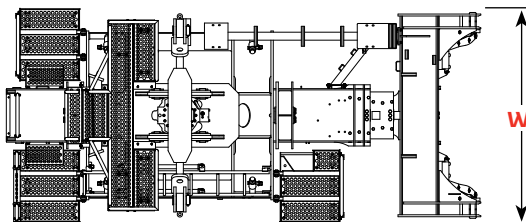
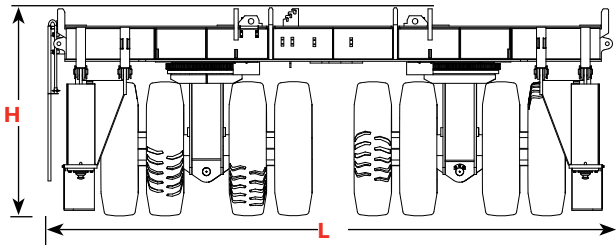

Lifting frame and telescopic beam

Length	6,04 m	19' 10"
Width	2,73 m	8' 11"
Height	2,99 m	9' 9"
Weight	16 828 kg	37,100 lb

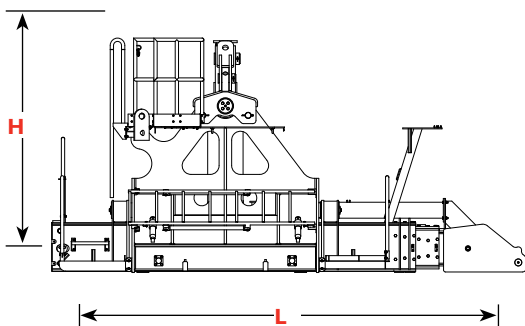

Outline dimensions

MAX-ER®

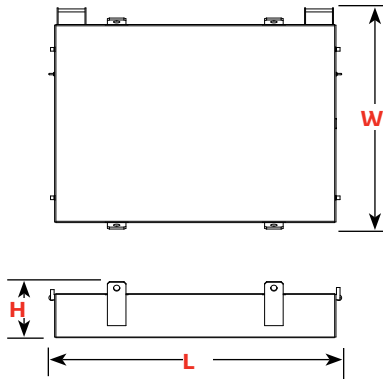

Side counterweight		x 2
Length	3,59 m	11' 9"
Width	2,72 m	8' 11"
Height	0,69 m	2' 3"
Weight	13 608 kg	30,000 lb

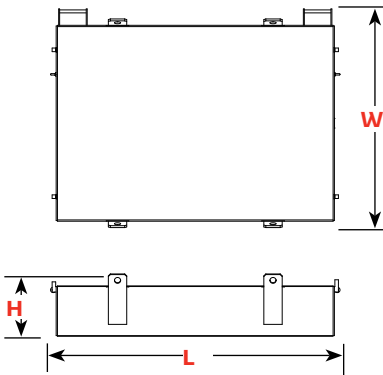

Side counterweight		x 8
Length	3,59 m	11' 9"
Width	2,72 m	8' 11"
Height	0,78 m	2' 6"
Weight	19 958 kg	44,000 lb

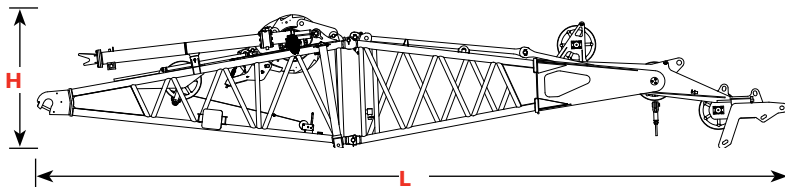

No. 59A mast butt and top package, drum, wire rope, equalizer		x 1
Length	14,84 m	48' 8"
Width	2,99 m	9' 10"
Height	2,66 m	8' 9"
Weight	20 593 kg	45,400 lb

Outline dimensions

MAX-ER®

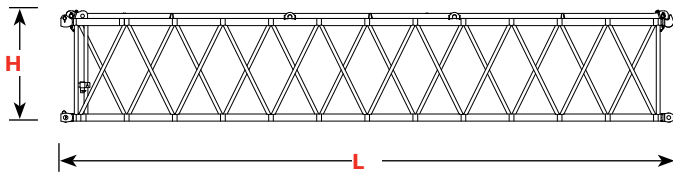

No. 59A mast insert 12 m (394')		
		x 1
Length	12,19 m	40' 0"
Width	2,72 m	8' 11"
Height	2,23 m	7' 4"
Weight	4 375 kg	9,645 lb

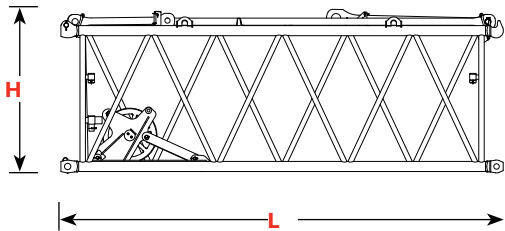

No. 59A mast insert 6 m (198')		
		x 1
Length	6,19 m	20' 4"
Width	2,72 m	8' 11"
Height	2,29 m	7' 6"
Weight	3 366 kg	7,420 lb

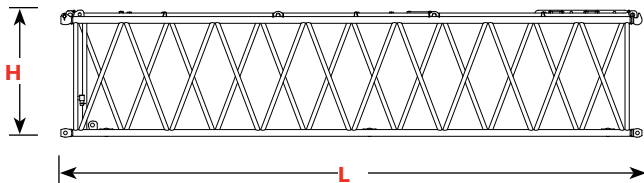

No. 58 heavy boom insert with equillizer rails 12 m (394')		
		x 1
Length	12,19 m	40' 0"
Width	2,98 m	9' 9"
Height	2,67 m	8' 9"
Weight	4 602 kg	10,145 lb

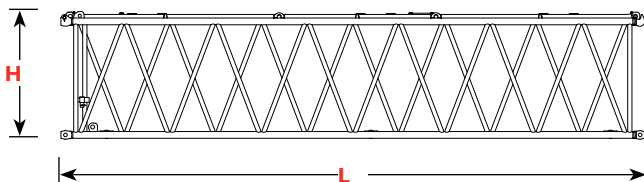

No. 58 heavy boom insert 12 m (394')		
		x 1
Length	12,19 m	40' 0"
Width	2,98 m	9' 9"
Height	2,67 m	8' 9"
Weight	5 087 kg	11,215 lb

Boom combinations

MAX-ER®

ANSI B30.5

No. 58 main boom with heavy-lift top combinations

Boom length m (ft)	Boom inserts m (ft)					
	5,0 [*] (16.4)	6,0 (19.7)	12,0 medium (39.4)	12,0 ^{**} (39.4)	12,0 ^{***} (39.4)	12,0 heavy (39.4)
42 (137.8)	1	0	0	1	1	0
48 (157.5)	1	1	0	1	1	0
54 (177.2)	1	0	0	1	1	1
60 (196.9)	1	1	0	1	1	1
66 (216.5)	1	0	1	1	1	1
72 (236.2)	1	1	1	1	1	1
78 (255.9)	1	0	2	1	1	1
84 (275.6)	1	1	2	1	1	1
90 (295.3)	1	0	3	1	1	1
96 (315.0)	1	1	3	1	1	1
102 (334.6)	1	0	4	1	1	1
108 (354.3)	1	1	4	1	1	1
114 (374.0)	1	0	5	1	1	1
120 (393.7)	1	1	5	1	1	1

*transition boom insert.
 **with auxiliary sheave insert.
 *** with equalizer rails insert.

No. 58 main boom with heavy-duty extended upper boom point combination

Boom length m (ft)	Boom inserts m (ft)					
	5,0 [*] (16.4)	6,0 (19.7)	12,0 medium (39.4)	12,0 ^{**} (39.4)	12,0 ^{***} (39.4)	12,0 heavy (39.4)
96 (315.0)	1	1	3	1	1	1

*transition boom insert.
 **with auxiliary sheave insert.
 *** with equalizer rails insert.

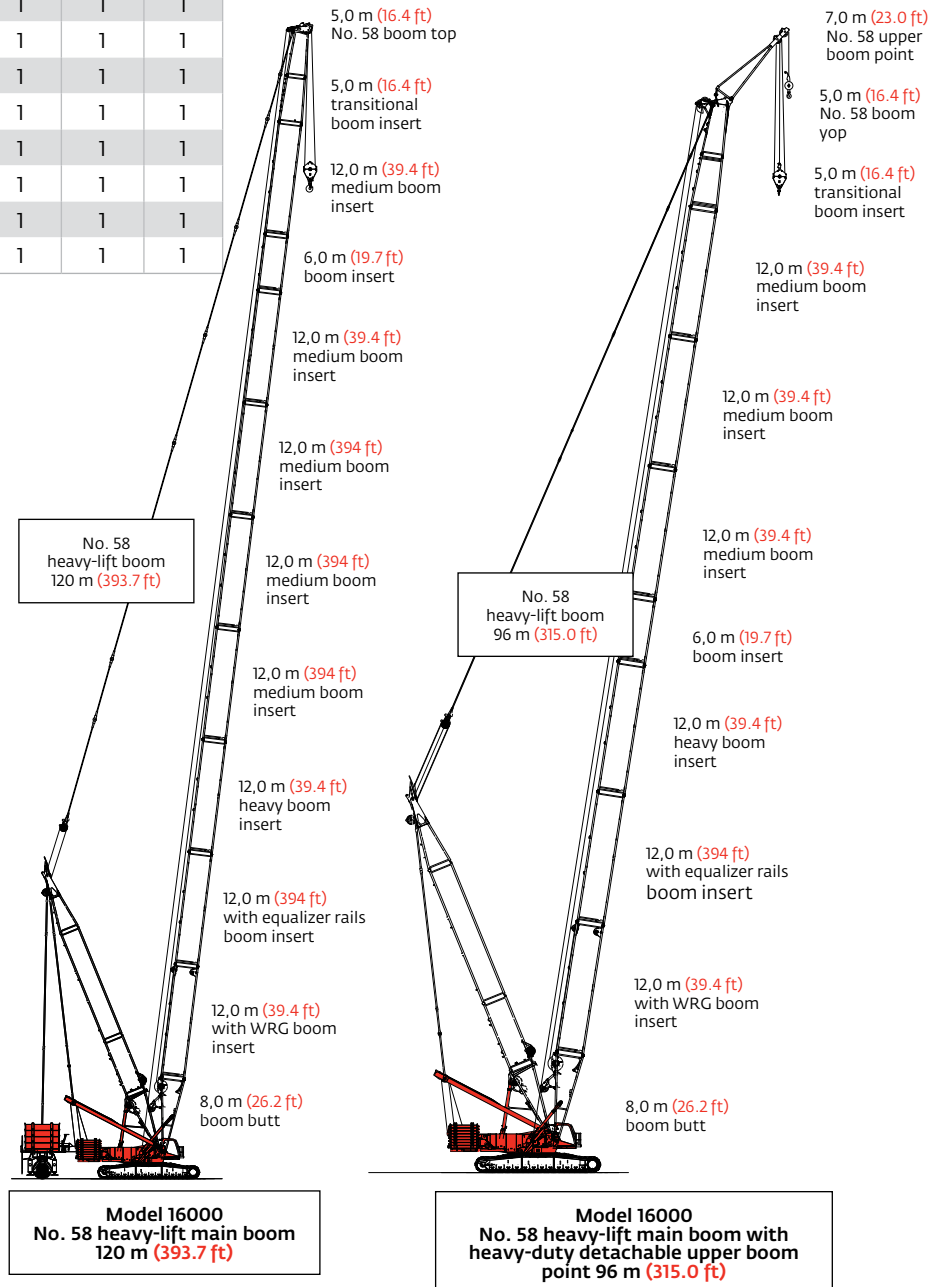

Boom combinations

MAX-ER®

ANSI B30.5

No. 59 luffing jib combinations

Luffing jib length m (ft)	Luffing jib inserts m (ft)	
	6,0 (19.7)	12,0 (39.4)
24 (78.7)	1	0
30 (98.4)	0	1
36 (118.1)	1	1
42 (128.1)	0	2
48 (157.5)	1	2
54 (177.24)	0	3
60 (196.9)	1	3
66 (216.5)	0	4
72 (236.2)	1	4
78 (255.9)	0	5
84 (275.6)	1	5

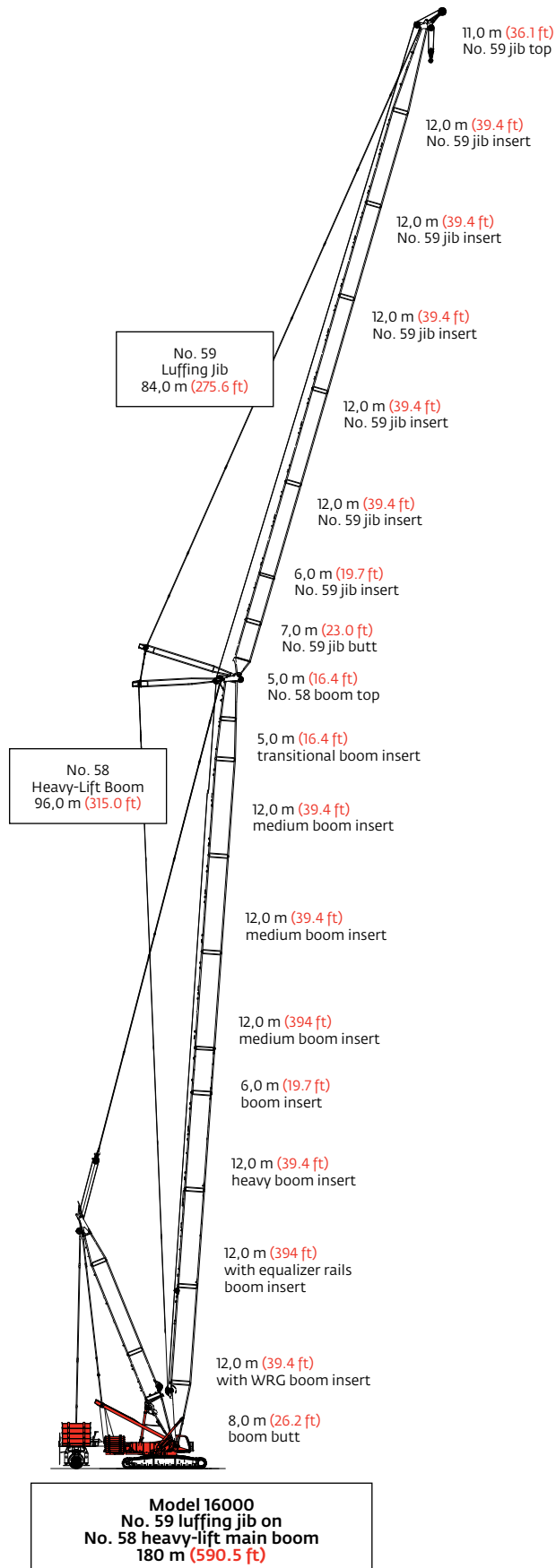

Heavy-lift boom range diagram

MAX-ER®

ANSI B30.5

Liftcrane boom capacities - Model 16000 MAX-ER®
 No. 58 heavy-lift main boom with 30,0 m (98.4 ft) mast No.59A

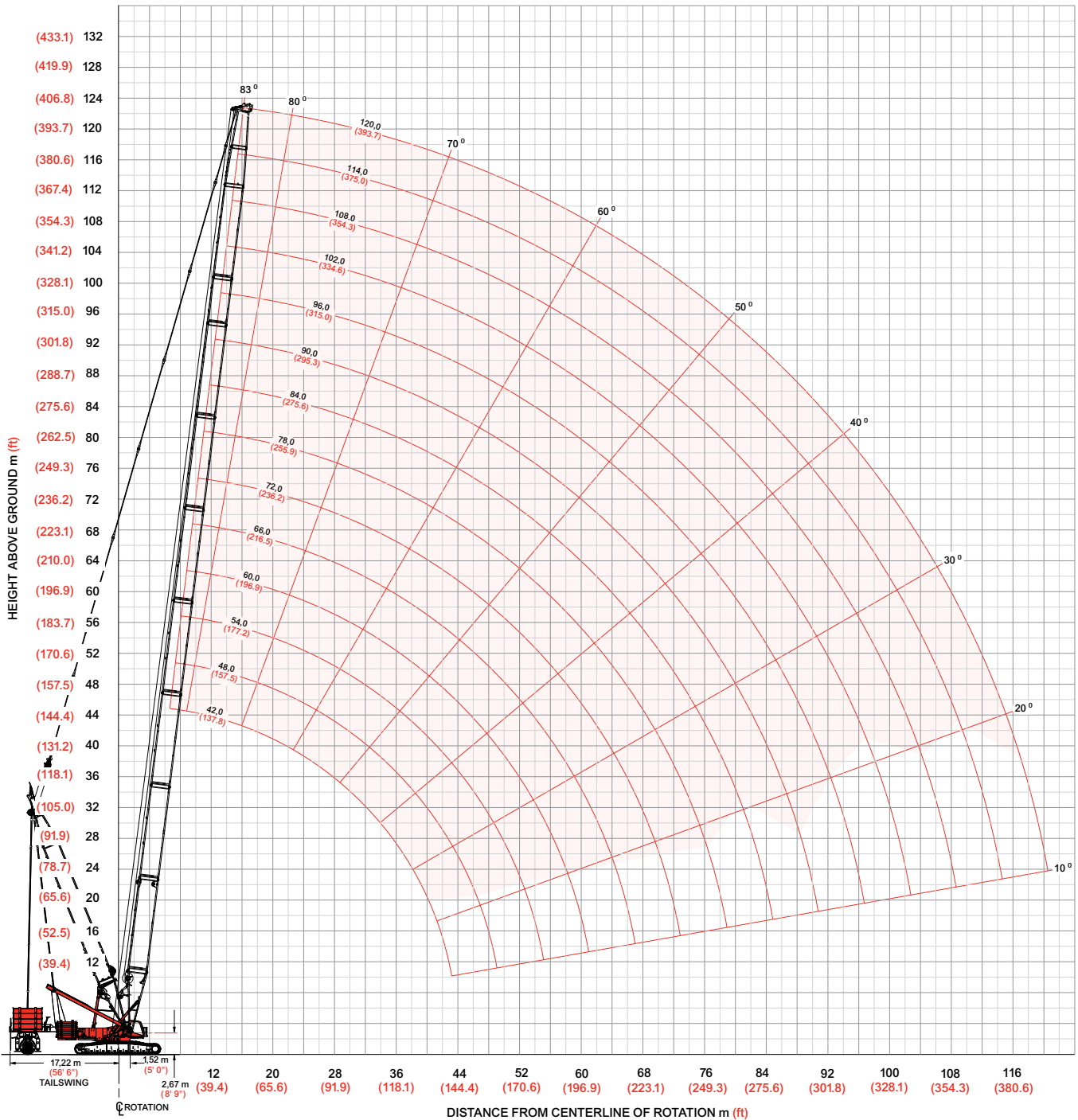

Heavy-lift boom load charts

MAX-ER®

ANSI B30.5

Liftcrane boom capacities - Model 16000 MAX-ER® with MAX-ER® at 15 m (49.2 ft) position
No. 58 heavy-lift main boom with 30,0 m (98.4 ft) mast No. 59A

Boom m (ft) Radius	150 590 kg (332,000 lb) Counterweight 54 430 kg (120,000 lb) Carbody counterweight 231 970 kg (511,400 lb) Wheeled counterweight 360° Rating kg (lb) x 1 000													
	42,0 (137.8)	48,0 (157.5)	54,0 (177.2)	60,0 (196.9)	66,0 (216.5)	72,0 (236.2)	78,0 (255.9)	84,0 (275.6)	90,0 (295.3)	96,0 (315.0)	102,0 (334.6)	108,0 (354.3)	114,0 (374.0)	120,0 (393.7)
7,9 (26)	379,8 (837.4)													
10,0 (34)	379,8 (837.4)	340,0 (749.7)	312,2 (688.1)	— (623.6)										
12,0 (40)	379,8 (837.4)	340,0 (749.7)	311,4 (686.4)	282,4 (622.6)	251,1 (553.8)	227,8 (502.3)	— (452.3)							
14,0 (50)	361,9 (728.0)	338,1 (726.9)	310,6 (675.6)	277,8 (605.4)	250,4 (545.6)	225,2 (491.5)	203,5 (445.5)	177,0 (390.3)	148,4 (327.2)	— (279.8)	— (237.7)			
18,0 (60)	278,9 (605.2)	278,4 (604.1)	279,5 (602.7)	267,1 (587.1)	241,4 (530.8)	217,8 (479.2)	198,9 (437.8)	177,0 (390.3)	148,4 (327.2)	126,9 (279.8)	107,8 (237.7)	92,9 (205.0)	79,7 (175.7)	— (152.1)
20,0 (70)	250,4 (516.4)	249,8 (515.2)	249,2 (513.9)	248,8 (512.3)	236,9 (511.7)	214,2 (466.9)	196,6 (430.3)	176,8 (386.1)	148,4 (327.2)	126,9 (279.8)	107,8 (237.7)	92,9 (204.7)	79,5 (175.4)	68,8 (151.8)
24,0 (80)	207,1 (449.1)	206,6 (448.0)	206,0 (446.7)	205,2 (445.1)	205,0 (444.5)	203,4 (442.8)	192,2 (422.9)	170,4 (374.3)	145,3 (319.1)	126,9 (279.8)	107,6 (237.4)	92,7 (204.4)	79,3 (174.9)	68,6 (151.3)
30,0 (100)	163,3 (354.1)	162,8 (352.9)	162,2 (351.6)	161,5 (350.1)	161,3 (349.6)	160,5 (347.8)	159,9 (346.5)	158,7 (344.7)	137,0 (300.8)	126,6 (278.9)	106,5 (234.5)	91,0 (200.4)	77,6 (170.8)	67,1 (147.8)
36,0 (120)	133,8 (289.9)	133,3 (288.9)	132,7 (287.6)	132,1 (286.1)	131,8 (285.6)	131,0 (283.9)	130,5 (282.6)	129,6 (280.8)	128,5 (279.8)	124,1 (273.1)	104,2 (229.4)	89,0 (195.9)	75,7 (166.7)	65,0 (142.0)
42,0 (140)		112,1 (242.7)	115,5 (241.5)	110,8 (240.0)	110,6 (239.6)	109,8 (237.9)	109,3 (236.6)	108,5 (234.8)	108,0 (233.8)	107,1 (231.8)	102,0 (224.3)	87,0 (191.4)	73,9 (162.5)	61,1 (134.0)
48,0 (160)			95,4 (206.6)	94,8 (205.2)	94,6 (204.8)	93,9 (203.2)	93,3 (202.0)	92,5 (200.1)	92,1 (199.2)	91,1 (197.2)	90,6 (196.0)	84,9 (186.8)	72,1 (158.4)	57,6 (126.0)
54,0 (180)				82,2 (177.9)	82,1 (177.6)	81,4 (176.0)	80,8 (174.8)	80,0 (173.0)	79,6 (172.1)	78,7 (170.1)	78,1 (168.9)	77,3 (167.0)	70,2 (154.4)	54,0 (118.0)
60,0 (200)					71,8 (155.2)	71,1 (153.7)	70,6 (152.6)	69,9 (150.9)	69,5 (150.0)	68,6 (148.1)	68,1 (147.0)	67,3 (145.2)	66,8 (143.9)	50,4 (110.0)
66,0 (220)						62,7 (135.3)	62,2 (134.3)	61,4 (132.7)	61,1 (131.8)	60,2 (129.9)	59,7 (128.8)	58,9 (127.0)	58,3 (125.7)	46,8 (102.0)
74,0 (240)							53,1 (119.0)	52,3 (117.4)	52,0 (116.6)	51,1 (114.7)	50,6 (113.6)	49,8 (111.8)	49,3 (110.6)	42,1 (94.0)
80,0 (260)								46,6 (104.4)	46,3 (103.7)	45,5 (101.9)	45,0 (100.8)	44,2 (99.0)	43,7 (97.8)	38,5 (86.0)
84,0 (280)									43,0 (92.6)	42,2 (90.8)	41,7 (89.8)	40,9 (88.0)	40,4 (86.8)	36,6 (80.0)
96,0 (300)										— (81.1)	33,4 (80.1)	32,6 (78.4)	32,1 (77.2)	31,1 (75.0)
100,0 (330)												30,3 (66.1)	29,8 (65.0)	28,8 (62.8)
108,0 (340)												— (56.4)	16,8 (61.2)	23,9 (58.5)
112,0 (350)													— (44.3)	21,6 (54.4)
116,0 (360)													— (27.8)	17,8 (50.6)

Extended upper boom point range diagram

ANSI B30.5

Liftcrane boom capacities - Model 16000

No. 58 heavy-lift main boom with 30,0 (98.4 ft) mast No. 59A and 7,0 m (23 ft) extended upper boom point

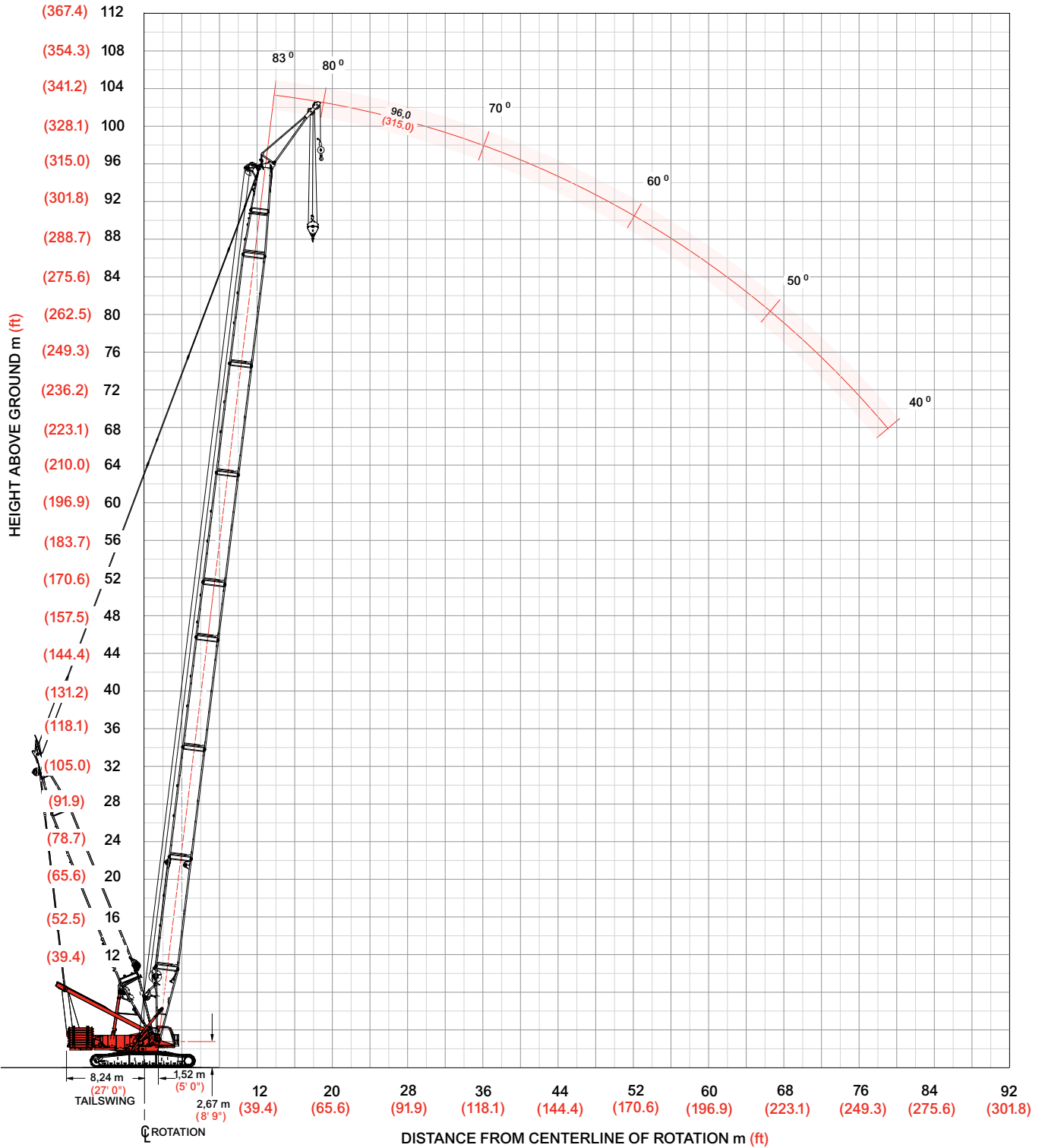

Extended upper boom point load charts

ANSI B30.5

Liftcrane boom capacities - Model 16000 No. 58 heavy-lift main boom with 30,0 (98.4 ft) mast No. 59A and 7,0 m (23 ft) extended upper boom point

Boom m (ft) Radius	150 590 kg (332,000 lb) Counterweight
	54 430 kg (120,000 lb) Carbody counterweight
	360° Rating kg (lb) x 1 000
	96,0 (315.0)
18,3 (60)	81,5 (179.8)
20,0 (65)	81,5 (179.8)
22,0 (70)	81,5 (179.8)
24,0 (80)	78,4 (170.7)
26,0 (85)	70,2 (155.8)
30,0 (100)	56,3 (121.2)
32,0 (105)	50,9 (112.2)
34,0 (110)	46,1 (104.1)
36,0 (115)	41,9 (96.8)
38,0 (125)	38,3 (84.1)
42,0 (140)	32,0 (68.7)
46,0 (150)	27,0 (60.3)
50,0 (165)	22,8 (49.8)
54,0 (175)	19,3 (43.8)
58,0 (190)	16,3 (36.1)
62,0 (200)	13,6 (31.6)
64,0 (210)	12,5 (27.6)
66,0 (215)	11,4 (25.7)
70,0 (230)	9,3 (20.6)
72,0 (235)	8,4 (19.0)
74,0 (245)	7,5 (16.0)
78,0 (255)	5,6 (12.7)
80,0 (260)	4,6 (11.1)
82,0 (270)	3,8 (8.1)

Luffing jib range diagram

MAX-ER®

ANSI B30.5

Liftcrane luffing jib capacities - Model 16000 MAX-ER® with MAX-ER® at 15 m (49.2 ft) position
 No. 59 luffing jib on No. 58 heavy-lift main boom

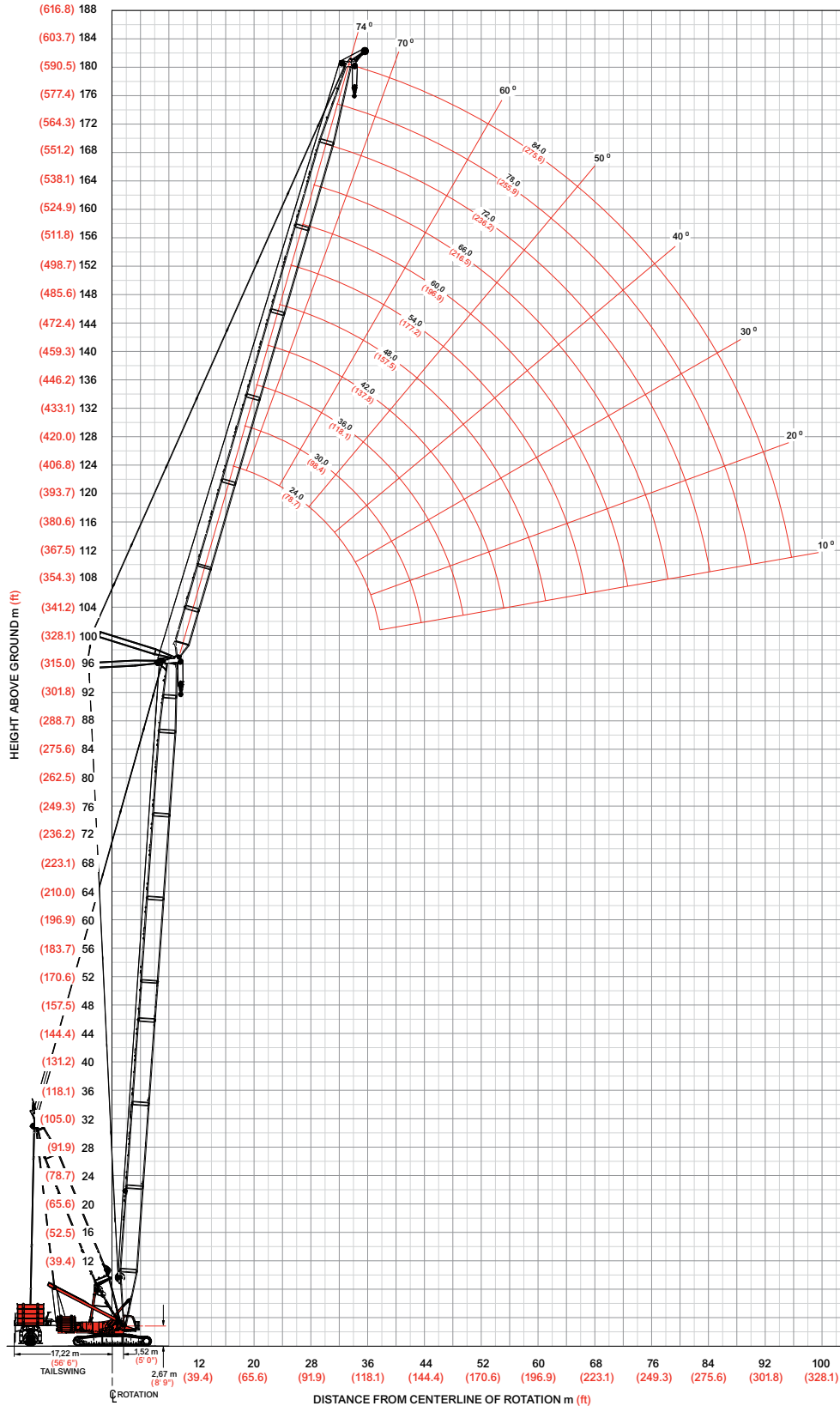

Luffing jib load charts

MAX-ER®

ANSI B30.5

Liftcrane luffing jib capacities - Model 16000 MAX-ER® with MAX-ER® at 15 m (49.2 ft) position
No. 59 luffing jib on No. 58 heavy-lift main boom

150 590 kg (332,000 lb) Counterweight 54 430 kg (120,000 lb) Carbody counterweight
 231 970 kg (511,400 lb) Wheeled counterweight
 360° Rating kg (lb) x1 000

86° Boom angle

Luffing jib length 24.0 m (79.0 ft)	150 590 kg (332,000 lb) Counterweight				54 430 kg (120,000 lb) Carbody counterweight				231 970 kg (511,400 lb) Wheeled counterweight			
	42,0 (138.0)	60,0 (197.0)	78,0 (256.0)	96,0 (315.0)	42,0 (138.0)	60,0 (197.0)	78,0 (256.0)	96,0 (315.0)	42,0 (138.0)	60,0 (197.0)	78,0 (256.0)	96,0 (315.0)
13,7 (45)	185,4 (408.9)	146,8 —			18,0 (55)	139,7 (321.0)			20,0 (65)	115,5 (255.6)		
14,0 (50)	181,7 (364.9)	129,8 (339.6)			20,0 (65)	124,2 (277.1)	111,3 (246.9)	76,4 (169.2)	22,0 (70)	111,7 (249.2)	85,3 (190.8)	
16,0 (55)	156,7 (308.0)	117,1 (307.6)	—	—	24,0 (80)	101,2 (219.4)	94,7 (205.7)	68,7 (149.9)	26,0 (85)	94,5 (209.3)	77,2 (170.7)	54,9 (121.5)
18,0 (60)	137,6 (298.5)	107,2 (281.8)	98,6 (216.0)	62,2 (135.9)	26,0 (85)	93,0 (205.8)	87,6 (193.8)	64,7 (143.2)	30,0 (100)	80,1 (173.7)	68,3 (148.4)	49,8 (108.5)
20,0 (65)	123,4 (274.7)	99,3 (260.7)	92,6 (205.6)	60,5 (133.8)	28,0 (90)	86,2 (194.1)	81,6 (183.6)	60,8 (136.6)	34,0 (110)	70,1 (156.9)	59,8 (134.0)	44,7 (99.9)
22,0 (70)	112,3 (255.1)	96,4 (243.1)	86,5 (195.3)	59,0 (131.4)	32,0 (105)	75,9 (167.5)	70,2 (154.8)	53,5 (118.0)	38,0 (125)	62,7 (138.1)	52,1 (114.6)	39,9 (87.8)
24,0 (80)	103,8 (225.8)	89,4 (216.3)	80,7 (175.6)	57,2 (125.4)	34,0 (110)	72,2 (161.0)	64,9 (145.7)	50,2 (112.5)	42,0 (135)	55,9 (127.2)	45,5 (103.3)	35,6 (80.6)
26,0 (85)	97,4 (215.3)	79,1 (206.6)	75,3 (166.7)	54,3 (120.2)	36,0 (120)	69,1 (150.9)	60,3 (130.4)	47,3 (102.8)	46,0 (150)	48,5 (108.0)	40,1 (89.3)	32,1 (71.3)
28,0 (90)	89,8 (207.8)	—	70,8 (158.8)	51,5 (115.4)	38,0 (125)	65,8 (144.6)	56,4 (124.1)	44,8 (98.6)	50,0 (165)	42,9 (94.0)	36,0 (79.0)	29,2 (64.2)
30,0 (100)		—	67,4 (147.4)	49,2 (107.7)	42,0 (135)	—	—	41,3 (92.2)	54,0 (180)			27,6 (60.8)
32,0 (105)				47,0 (103.8)	44,0 (145)			30,9 (68.1)	56,0 (185)			21,1 (46.6)

Luffing jib length 60.0 m (197.0 ft)	150 590 kg (332,000 lb) Counterweight				54 430 kg (120,000 lb) Carbody counterweight				231 970 kg (511,400 lb) Wheeled counterweight			
	42,0 (138.0)	60,0 (197.0)	78,0 (256.0)	96,0 (315.0)	42,0 (138.0)	60,0 (197.0)	78,0 (256.0)	96,0 (315.0)	42,0 (138.0)	60,0 (197.0)	78,0 (256.0)	96,0 (315.0)
24,0 (75)	79,7 (176.3)				28,0 (90)	55,4 (122.6)	46,9 (103.7)		32,0 (100)	39,4 (87.6)		
28,0 (90)	78,3 (174.1)	61,0 (136.0)	43,8 (97.6)	30,1 (66.8)	32,0 (105)	54,5 (120.2)	46,0 (101.6)	33,6 (74.2)	38,0 (125)	38,0 (83.9)	33,6 (74.2)	25,1 (55.3)
32,0 (105)	71,4 (157.4)	55,8 (123.2)	40,6 (89.5)	28,7 (63.4)	38,0 (125)	51,6 (113.6)	41,3 (90.9)	30,4 (67.0)	44,0 (145)	36,7 (80.9)	30,9 (68.1)	22,9 (50.4)
38,0 (125)	60,5 (133.0)	47,7 (105.0)	35,4 (78.0)	25,4 (56.1)	44,0 (145)	45,4 (99.7)	36,2 (79.6)	27,0 (59.3)	50,0 (165)	34,3 (75.2)	27,7 (60.8)	20,6 (45.3)
42,0 (135)	53,5 (121.3)	42,6 (96.3)	32,1 (72.4)	23,4 (52.6)	50,0 (165)	39,3 (86.1)	31,4 (68.8)	23,7 (52.0)	56,0 (185)	30,5 (66.9)	24,6 (53.8)	18,4 (40.4)
46,0 (150)	47,2 (105.1)	37,9 (84.3)	29,0 (64.6)	21,4 (47.5)	54,0 (180)	35,6 (76.8)	28,5 (61.6)	21,7 (47.0)	62,0 (205)	27,1 (59.2)	21,7 (47.4)	16,3 (35.8)
50,0 (165)	41,7 (91.2)	33,8 (74.0)	26,3 (57.6)	19,6 (43.0)	58,0 (190)	32,1 (71.1)	25,8 (57.2)	19,9 (44.0)	68,0 (225)	23,9 (52.3)	19,2 (41.9)	14,6 (31.9)
56,0 (185)	35,0 (76.4)	28,7 (62.8)	22,9 (50.1)	17,3 (37.9)	64,0 (210)	27,8 (61.3)	22,5 (49.6)	17,5 (38.7)	74,0 (245)	21,3 (46.3)	17,0 (37.1)	13,0 (28.5)
60,0 (200)	31,5 (68.1)	26,2 (56.7)	21,1 (45.8)	16,1 (35.0)	70,0 (230)	24,3 (53.6)	19,9 (43.8)	15,7 (34.7)	80,0 (265)	18,2 (39.4)	15,3 (33.5)	11,8 (26.0)
64,0 (210)	27,0 (59.7)	24,4 (54.0)	19,9 (43.9)	15,2 (33.6)	76,0 (250)	21,6 (40.5)	18,2 (40.2)	14,6 (32.2)	86,0 (285)	14,5 (30.2)	14,1 (31.1)	11,1 (24.4)
68,0 (225)				14,9 (33.0)	80,0 (265)			10,7 (23.7)	92,0 (305)			7,5 (15.9)

Manitowoc Crane Care

Crane Care is Manitowoc's comprehensive service and support program. It includes classroom and on-site training, prompt parts availability, expert field service, technical support and documentation.

That's commitment you won't find anywhere else.

That's Crane Care.

Service training

Manitowoc specialists work with you in our training centers and in the field to make sure you know how to get maximum performance, reliability and life from your cranes.

Manitowoc Cranes Technical Training Centers provide valuable multi-level training, which is available for all models and attachments, in the following format:

- **Intro to Canbus and Canbus 1, 2, 3**
- **Intro to EPIC and EPIC 1, 2, 3**
- **Small Crawler 1**
- **Canbus 1 and 2 assembly, operation and maintenance**
- **EPIC 1 and 2 assembly, operation and maintenance**

Refer to www.manitowoc.com for course descriptions.

Parts availability

Genuine Manitowoc replacement parts are accessible through your distributor 24 hours a day, 7 days a week, 365 days a year.

Service interval kits

200 hour kit

1,000 hour kit

2,000 hour kit

Hydraulic test kit

U.S. standard tools kit

Field service

Factory-trained service experts are always ready to help maintain your crane's peak performance.

For a worldwide listing of dealer locations, please consult our website at: www.manitowoc.com

Technical support

Manitowoc's dealer network and factory personnel are available 24 hours a day, 7 days a week, 365 days a year to answer your technical questions and more, with the help of computerized programs that simplify crane selection, lift planning, and ground-bearing calculations.

For a worldwide listing of dealer locations, please consult our website at: www.manitowoc.com

Technical documentation

Manitowoc has the industry's most extensive documentation; available in major languages and formats that include print, videotape, and DVD/CD.

Additional copies available through your Authorized Manitowoc Distributor.

- Crane operator's manual
- Crane parts manual
- Crane capacity manual
- Crane vendor manual
- Crane service manual
- Luffing jib operator's/parts manual
- Capacity chart manual - attachments

CD rom versions of the operator's and parts manuals are shipped with each crane. Also available are the following CDs:

- Crane Care Owner CD –
- Ground Bearing Pressure Estimator CD
- Crane Selection and Planning Software (CompuCRANE®)
- EPIC® Crane Library CD consisting of capacity charts, range diagrams, wire rope specifications, travel specifications, crane weights, counterweight arrangements, luffing jib raising procedures, operating range diagrams, drum and lagging charts, boom rigging drawings, jib rigging drawings, outline dimensions and wind condition charts.

Available from your Authorized Manitowoc Cranes Distributor, these videos are available in NTSC, PAL, SECAM, and DVD formats.

- Your Capacity Chart Video
- Respect the Limits Video
- Crane Safety Video
- Boom Inspection/Repair Video

Crane Care Package

Manitowoc has assembled all of the available literature, CD's and videos listed above plus several Manitowoc premiums into one complete Crane Care Package.

Notes

Regional headquarters

Manitowoc - Americas

Manitowoc, Wisconsin, USA

Tel: +1 920 684 6621

Fax: +1 920 683 6277

Shady Grove, Pennsylvania, USA

Tel: +1 717 597 8121

Fax: +1 717 597 4062

Manitowoc - Europe, Middle East, Africa

Ecully, France

Tel: +33 (0)4 72 18 20 20

Fax: +33 (0)4 72 18 20 00

Manitowoc - Asia - Pacific

Shanghai, China

Tel: +86 21 6457 0066

Fax: +86 21 6457 4955

Regional offices

Americas

Brazil

Alphaville

Mexico

Monterrey

Chile

Santiago

Europe, Middle East, Africa

Czech Republic

Netvorice

France

Baudemont

Cergy

Decines

Germany

Langenfeld

Hungary

Budapest

Italy

Parabiago

Netherlands

Breda

Poland

Warsaw

Portugal

Baltar

Russia

Moscow

U.A.E.

Dubai

U.K.

Gawcott

Asia - Pacific

Australia

Brisbane

Melbourne

Sydney

China

Beijing

Chengdu

Guangzhou

India

Hyderabad

Pune

Korea

Seoul

Philippines

Makati City

Singapore

Factories

Brazil

Alphaville

China

TaiAn

Zhangjiagang

France

Charlieu

La Clayette

Moulins

Germany

Wilhelmshaven

India

Pune

Italy

Niella Tanaro

Portugal

Baltar

Fânzeres

Slovakia

Saris

USA

Manitowoc

Port Washington

Shady Grove

This document is non-contractual. Constant improvement and engineering progress make it necessary that we reserve the right to make specification, equipment, and price changes without notice. Illustrations shown may include optional equipment and accessories and may not include all standard equipment.