

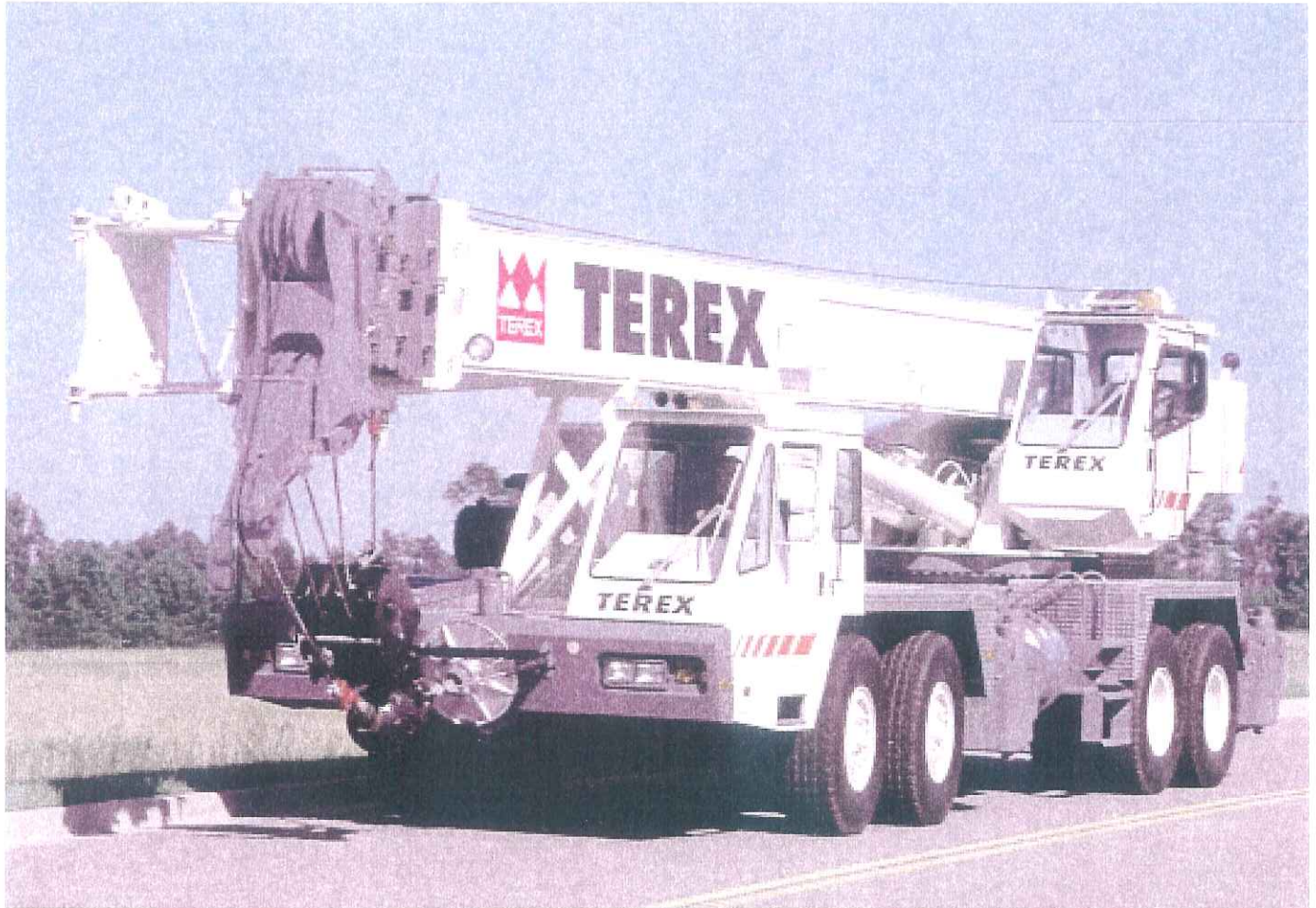

TEREX T 750 Truck Crane



FEATURES

- **75 ton (68 mt) maximum lifting capacity**
- **126 ft. (38.4 m) maximum boom length**
- **192 ft. (58.5 m) maximum tip height**
- Four-section full power boom with single lever control
- Swingaway jib offsettable 0°, 17° or 30°
- Two-speed main and auxiliary winches
- Quick-reeving boom head and hook block
- Fully independent multi-position out and down outriggers
- Environmental operator's cab optimizes load visibility and productivity
- Travel speeds to 55 mph (88 km/h)
- Tight 42 ft. 9 in. (13 m) turning radius
- Easy to read load chart books include range diagrams
- 12-month or 2000 hours warranty, major weldments are 5-years or 10,000 hours

simple, available and
cost effective™

Machines shown may have optional equipment.

TEREX T 750

Truck Crane

Max. Lifting Capacity: 75 tons (68 mt)

126 ft. (38.4 m) FOUR-SECTION, FULL-POWER BOOM WITH SINGLE LEVER CONTROL

- High strength, four plate construction.
- Two double-acting boom hoist cylinders provide boom elevation of -2° to 78° for easier reeving changes and close radius operation.
- Quick-reeving boom head; no need to remove wedge from socket.

ENVIRONMENTAL OPERATOR'S CAB – UPPER

- Rated Capacity Indicator (RCI) system including anti-two block system with automatic function disconnects.
- Fully adjustable operator's seat has shock-absorbing suspension and adjustable arm rests.
- Sound and weather insulated for comfort.
- Hinged tinted skylight and sliding right-hand, rear and door windows, roof wiper.
- Armrest mounted joystick or twin lever controls for swing, auxiliary winch, main winch and boom hoist; foot control pedals for swing brake, boom telescope and engine throttle.
- Complete instrumentation. Environmentally-sealed rocker switches. Circuit breakers in cab.



RUGGED, EASY-TO-MANEUVER CARRIER

- 10 ft. (3 m) wide chassis is Terex designed and built with 8 x 4 drive.
- Full aluminum decking, fenders and rims.
- Ground level outrigger controls are built into rear fenders.
- 13 forward, 2 reverse RoadRanger transmission.
- Dual circuit, air self-adjusting front and rear service brakes.
- Fully independent hydraulic outriggers may be utilized fully extended to 23 ft. 7.5 in. (7.2 m), in their mid extended position or fully retracted positions.
- 414 HP (309 kw) Detroit Diesel S60 engine.

POWERFUL, TWO-SPEED WINCHES

- 456 fpm (181 mpm) maximum line speed, 20,400 lbs. (9250 kg) maximum line pull. Single lever control.
- Integral automatic brake.

- Electronic drum indicators.
- Winch drum rollers.

HIGH CAPACITY, DEPENDABLE HYDRAULIC SYSTEM

- Two tandem gear-type pumps driven off front of carrier engine. Combined system capability is 158 gpm (598 lpm).
- Hydraulic reservoir with 177 gal. (615 l) capacity and full flow oil filtration system.

OPTIONS INCLUDE:

- 38 ft. or 38 to 60 ft. (11.6 or 11.6 to 18.3 m) swingaway jib. Both offset 0°, 17° or 30°.
- Auxiliary winch with rope and drum roller.
- Heater/defroster, air conditioner for operator's cab; air conditioner for carrier cab.
- Cold weather kit for carrier cab.

For more information, product demonstration, or details on purchase, lease and rental plans, please contact your local Terex Cranes Distributor.

We reserve the right to amend these specifications at any time without notice. The only warranty applicable is our standard written warranty applicable to the particular product and sale. We make no other warranty, expressed or implied.

 **TEREX CRANES**

Highway 501 East/P.O. Box 260002
Conway, SC 29528-6002 USA
(843) 349-6900 • FAX: (843) 349-7090
E-mail: conway@terexlifting.com

www.terexlift.com

TEREX T750

Truck Crane
75 Ton Capacity

Range diagram & lifting capacities

T 750 RANGE DIAGRAM RANGE DIAGRAM T 750 126' FULL POWER BOOM

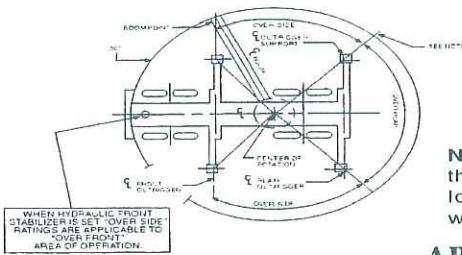
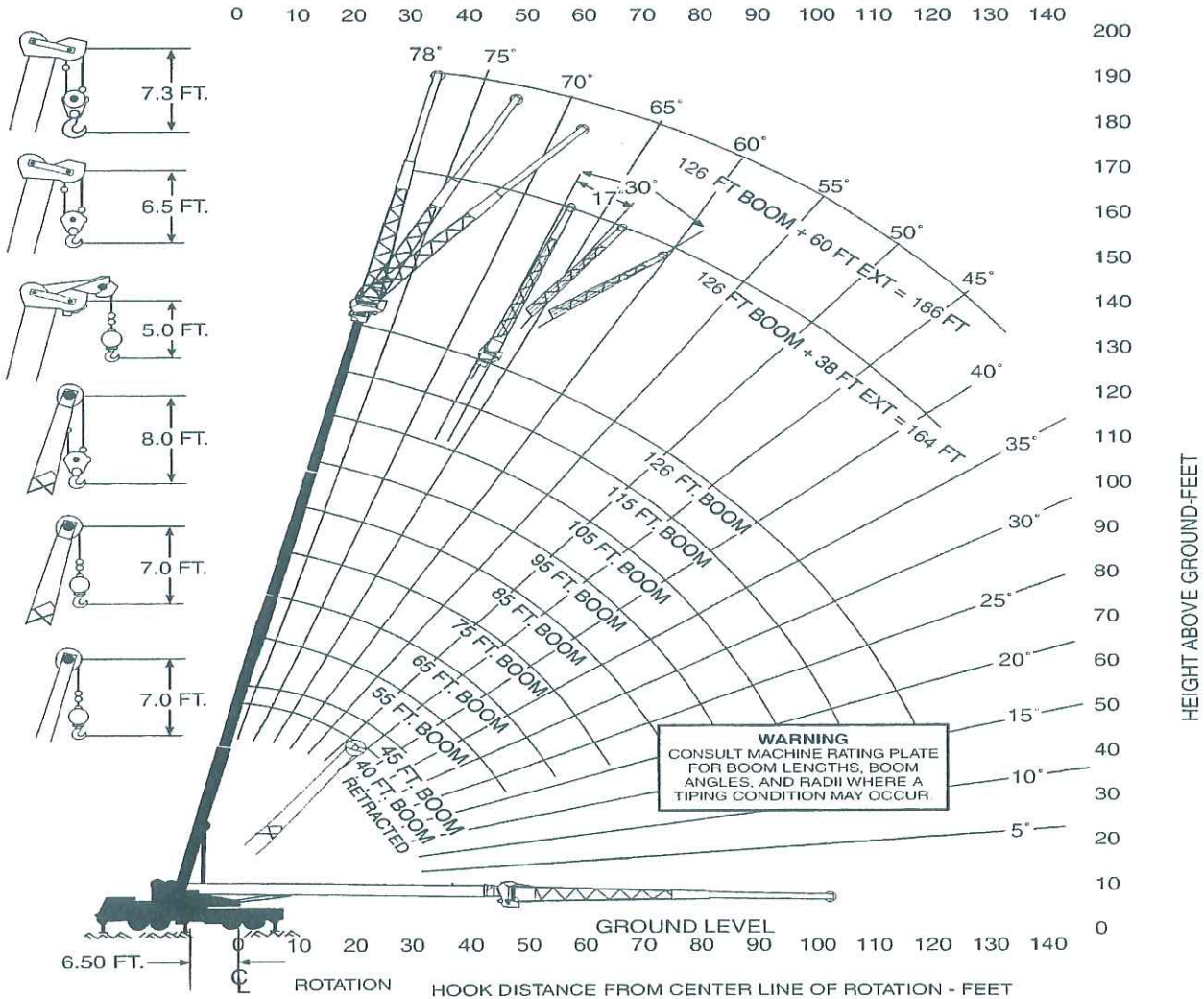

ON OUTRIGGERS

NOTE: These lines determine the limiting position of any load for operating within working areas indicated.

AREAS OF OPERATION

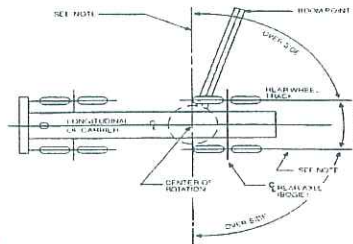

ON TIRES

RATED LIFTING CAPACITIES IN POUNDS

40.5 - 126 FT BOOM ON FULLY EXTENDED OUTRIGGERS - 360°
9700 POUND TOTAL COUNTERWEIGHT

9700 POUND TOTAL COUNTERWEIGHT

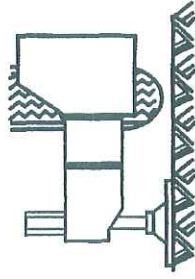
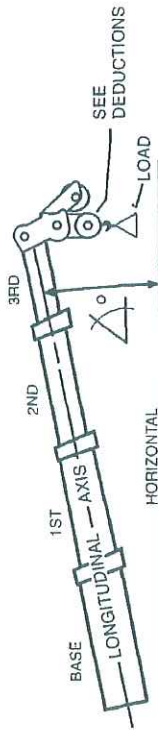

POWERED BOOM LENGTH IN FEET

LOAD RADIUS FT.	40.5 FT		45 FT		55 FT		65 FT		75 FT		85 FT		95 FT		105 FT		115 FT		126 FT			
	LOADED BOOM ANGLE Δ°	LOAD, LB	LOADED BOOM ANGLE Δ°	LOAD, LB	LOADED BOOM ANGLE Δ°	LOAD, LB	LOADED BOOM ANGLE Δ°	LOAD, LB	LOADED BOOM ANGLE Δ°	LOAD, LB	LOADED BOOM ANGLE Δ°	LOAD, LB	LOADED BOOM ANGLE Δ°	LOAD, LB	LOADED BOOM ANGLE Δ°	LOAD, LB	LOADED BOOM ANGLE Δ°	LOAD, LB	LOADED BOOM ANGLE Δ°	LOAD, LB	LOAD RADIUS FT.	
10	68	150000	71	102000	74	95000															10	
12	65	116000	68	100000	72	94700	75	77800														12
15	60	92500	64	91700	69	89000	73	73200	75	61000												15
20	51	68600	56	69500	63	69000	68	64000	71	58700	74	48200	76	40000								20
25	41	55600	48	55200	57	54600	63	54000	67	44500	70	39000	73	36300	75	31800						25
30	28	44500	38	44700	50	45100	58	45000	63	33400	67	29500	70	32400	72	28800	74	25400	76	22500		30
35			25	34800	43	35400	52	35400	58	35000	63	33400	67	29500	69	23100	74	20500	74	20500		35
40					34	27300	46	27600	54	27800	59	27200	63	26700	66	23200	69	21000	72	18900	40	40
45					22	21600	39	21900	48	22100	55	22300	60	21900	63	21000	66	19200	69	17100	45	45
50							31	17700	43	17900	50	18100	56	18300	60	18300	60	18300	64	17500	50	50
55							21	14400	37	14700	46	14800	52	15100	57	15100	61	15200	64	14800	55	55
60									29	12100	40	12300	48	12600	53	12600	57	12600	61	12700	60	60
65									19	10000	35	10200	43	10500	49	10400	54	10500	58	10600	65	65
70											28	8400	38	8800	46	8700	51	8700	56	8800	70	70
75											18	7000	33	7300	41	7200	47	7300	53	7400	75	75
80													26	6100	37	6000	44	6000	49	6100	80	80
85													17	5000	31	4900	40	5000	46	5000	85	85
90															25	3900	35	4000	43	4100	90	90
95																	17	3100	30	3200	95	95
100																			24	2400	100	100
ZERO DEGREE BOOM ANGLE LOADS (LB) / (RADIUS (FT.))																						
0	30000 (34.0)	0	18700 (38.5)	0	12300 (48.5)	0	8600 (58.5)	0	6300 (68.5)	0	4700 (78.5)	0	3200 (88.5)	0	0	0	0	0	0	0	0	(98.5)

MIN. BOOM ANGLE (DEG) FOR INDICATED BOOM LENGTH (NO LOAD) -2
MAX. BOOM LENGTH (FEET) AT -2 DEGREE BOOM ANGLE (NO LOAD) 105

RATED LIFTING CAPACITIES IN POUNDS

126 FT BOOM FULLY EXTENDED
 126 FT. BOOM PLUS EXTENSION
 FULLY EXTENDED OUTRIGGERS - 360°

9700 POUND TOTAL COUNTER WEIGHT

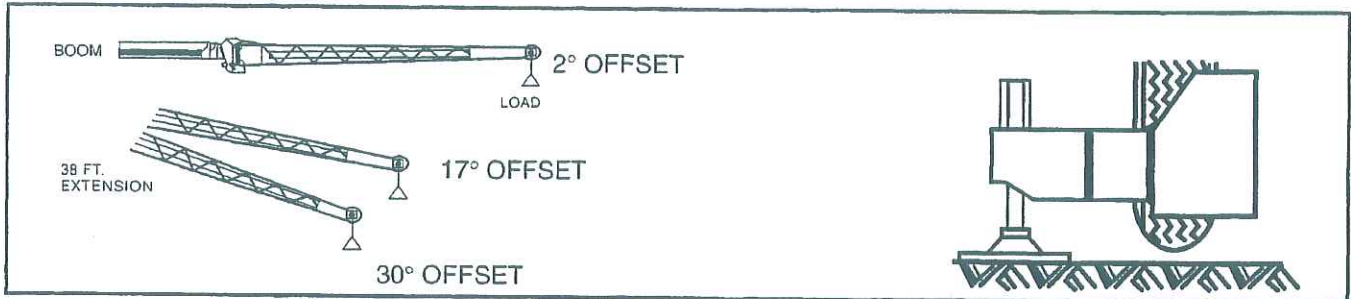

2 DEG EXT OFFSET WITH STINGER RETRACTED		REF. LOAD RADIUS FT.
FOR BOOM LENGTHS >128.0 FT - 164 FT		
LOADED BOOM ANGLE Δ°	LOAD, LB 360°	FOR 164 FOOT BOOM ONLY
77	11200	40
75	10500	45
74	9900	50
72	9300	55
70	8800	60
68	8300	65
67	7800	70
65	7400	75
63	6900	80
60	5800	85
58	4800	90
53	3200	100

17 DEG EXT OFFSET WITH STINGER RETRACTED		REF. LOAD RADIUS FT.
FOR BOOM LENGTHS >128.0 FT - 164 FT		
LOADED BOOM ANGLE Δ°	LOAD, LB 360°	FOR 164 FOOT BOOM ONLY
77	8700	50
75	8400	55
73	8000	60
72	7700	65
70	7300	70
68	6900	75
66	6500	80
64	6200	85
61	5600	90
56	3800	100
51	2400	110

30 DEG EXT OFFSET WITH STINGER RETRACTED		REF. LOAD RADIUS FT.
FOR BOOM LENGTHS >128.0 FT - 164 FT		
LOADED BOOM ANGLE Δ°	LOAD, LB 360°	FOR 164 FOOT BOOM ONLY
77	6800	55
75	6500	60
74	6400	65
72	6200	70
70	6000	75
68	5800	80
66	5700	85
63	5500	90
59	4300	100
53	2800	110

2 DEG EXT OFFSET WITH STINGER EXTENDED		REF. LOAD RADIUS FT.
FOR BOOM LENGTHS >150.0 FT - 186 FT		
LOADED BOOM ANGLE Δ°	LOAD, LB 360°	FOR 186 FOOT BOOM ONLY
77	7100	45
76	6800	50
75	6600	55
73	6300	60
72	6100	65
70	5700	70
68	5500	75
67	5300	80
65	5200	85
64	5100	90
60	4600	100
56	3300	110
51	2200	120

17 DEG EXT OFFSET WITH STINGER EXTENDED		REF. LOAD RADIUS FT.
FOR BOOM LENGTHS >150.0 FT - 186 FT		
LOADED BOOM ANGLE Δ°	LOAD, LB 360°	FOR 186 FOOT BOOM ONLY
77	5000	60
76	4900	65
74	4600	70
72	4400	75
71	4200	80
69	4100	85
67	3900	90
64	3400	100
60	3400	110
56	2900	120
51	1900	130

30 DEG EXT OFFSET WITH STINGER EXTENDED		REF. LOAD RADIUS FT.
FOR BOOM LENGTHS >150.0 FT - 186 FT		
LOADED BOOM ANGLE Δ°	LOAD, LB 360°	FOR 186 FOOT BOOM ONLY
77	3700	70
76	3600	75
74	3500	80
72	3300	85
70	3200	90
67	3100	100
63	3000	110
59	2700	120
54	2100	130

RATED LIFTING CAPACITIES IN POUNDS

40.5 - 75 FT BOOM ON TIRES
CREEP - OVER REAR

9700 POUND TOTAL COUNTER WEIGHT

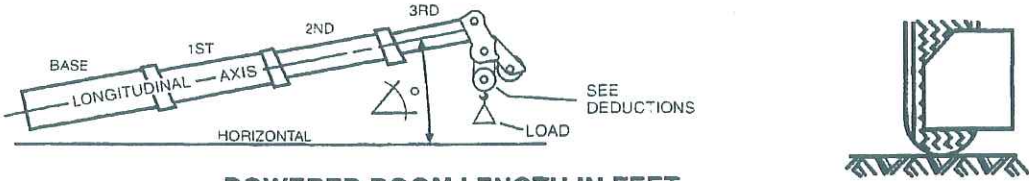

POWERED BOOM LENGTH IN FEET

LOAD RADIUS FT.	40.5 FT		45 FT		55 FT		65 FT		75 FT		LOAD RADIUS FT.
	LOADED BOOM ANGLE Δ°	LOAD, LB REAR	LOADED BOOM ANGLE Δ°	LOAD, LB REAR	LOADED BOOM ANGLE Δ°	LOAD, LB REAR	LOADED BOOM ANGLE Δ°	LOAD, LB REAR	LOADED BOOM ANGLE Δ°	LOAD, LB REAR	
10	68	32600	70	32300	74	31600					10
12	65	29500	68	29200	72	28700	75	28200			12
15	60	25500	63	25400	69	25000	72	24600	75	24200	15
20	51	20400	56	20300	63	20100	67	19900	71	19600	20
25	41	16300	47	16300	57	16200	62	16100	67	15900	25

ZERO DEGREE BOOM ANGLE LOADS (LB) / (RADII (FT.))

0	9100 (34.0)	0	6700 (38.5)	0	3200 (48.5)		0 (58.5)		—	
---	----------------	---	----------------	---	----------------	--	-------------	--	---	--

MINIMUM BOOM ANGLE (DEG) FOR INDICATED BOOM LENGTH (NO LOAD)	-2
MAXIMUM BOOM LENGTH (FEET) AT -2 DEGREE BOOM ANGLE (NO LOAD)	65

TIRE INFLATION CHART		
TIRE SIZE	LOADING	CREEP
14.00R20	90	105
315/80R22.5	115	115
425/65R22.5	120	120

2080 MAIN & AUXILIARY HOIST REEVING 6 X 37										
.75 INCH (19mm) DIAMETER ROPE BREAKING STRENGTH 58800 LB. (26600 KG)										
PARTS OF LINE	1	2	3	4	5	6	7	8	9	10
MAXIMUM LOAD-LBS.	15000	30000	45000	60000	75000	90000	105000	120000	135000	150000
MAXIMUM LOAD-KGS.	6800	13600	20400	27200	34000	40800	47600	54400	61200	68100

HOIST REEVING 8 X 19 ROTATION RESISTANT										
.75 INCH (19mm) DIAMETER ROPE BREAKING STRENGTH 51800 LB. (23500 KG)										
PARTS OF LINE	1	2	3	4	5	6	7	8	9	10
MAXIMUM LOAD-LBS.	10350	20700	31050	41400	51750	62100	72450	82800	93150	103500
MAXIMUM LOAD-KGS.	4600	9300	14000	18700	23400	28100	32800	37500	42200	46900

RATED LIFTING CAPACITIES IN POUNDS

40.5 - 126 FT BOOM ON FULLY EXTENDED OUTRIGGERS - OVER REAR
 9700 POUND TOTAL COUNTERWEIGHT LOAD MOMENT DEVICE (LMI) CODE # 04

9700 POUND TOTAL COUNTERWEIGHT

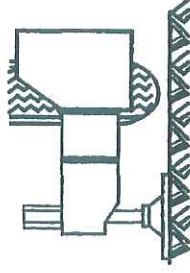
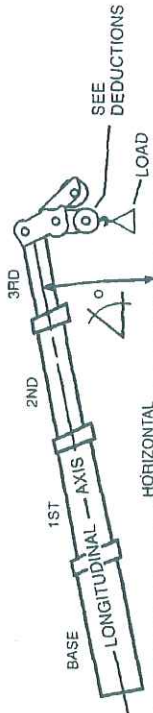

POWERED BOOM LENGTH IN FEET

LOAD RADIUS FT.	40.5 FT		45 FT		55 FT		65 FT		75 FT		85 FT		95 FT		105 FT		115 FT		126 FT				
	LOADED BOOM ANGLE Δ°	LOAD, LB REAR	LOADED BOOM ANGLE Δ°	LOAD, LB REAR	LOADED BOOM ANGLE Δ°	LOAD, LB REAR	LOADED BOOM ANGLE Δ°	LOAD, LB REAR	LOADED BOOM ANGLE Δ°	LOAD, LB REAR	LOADED BOOM ANGLE Δ°	LOAD, LB REAR	LOADED BOOM ANGLE Δ°	LOAD, LB REAR	LOADED BOOM ANGLE Δ°	LOAD, LB REAR	LOADED BOOM ANGLE Δ°	LOAD, LB REAR	LOADED BOOM ANGLE Δ°	LOAD, LB REAR			
10	68	150000	71	102000	74	95000																	
12	65	116000	68	100000	72	94700	75	77800															
15	60	92500	64	91700	69	89000	73	73200	75	61000													
20	51	69500	56	69500	63	69000	68	64000	71	57700	74	48200	76	40000									
25	41	55600	48	55200	57	54600	63	54000	67	48500	70	42200	73	36300	75	31600							
30	28	44500	38	44700	50	45100	58	45000	63	44500	67	39000	70	32400	72	28800	74	25400	76	22500			
35			25	36000	43	35800	52	35400	58	35000	63	33400	67	29500	69	25800	72	23100	74	20500			
40					34	28300	46	28000	54	27800	59	27200	63	26700	66	23200	69	21000	72	18800			
45					22	23300	39	23700	49	23100	55	22500	60	21900	63	21000	66	19200	69	17100			
50							31	19400	43	19700	50	19800	56	18900	60	18400	64	17500	67	15700			
55								21	16200	37	16400	46	16500	52	16800	57	16700	61	16000	64	14800		
60									29	13700	40	13900	48	14200	53	14100	58	14200	61	13600			
65									19	11600	35	11700	43	12100	50	12000	54	12000	59	12100			
70											28	9900	38	10300	46	10200	51	10200	56	10300			
75											18	8400	33	8800	41	8600	48	8700	53	8800			
80													26	7500	37	7300	44	7400	50	7500			
85													17	6300	32	6200	40	6300	46	6300			
90															25	5200	35	5300	43	5300			
95															17	4300	30	4400	39	4500			
100																	24	3600	35	3700			
110																			25	2300			
0	23000 (34.0)	0	18700 (38.5)	0	12300 (48.5)	0	8600 (98.5)	0	6300 (98.5)	0	4700 (78.5)	0	3400 (98.5)	0	2500 (98.5)	0	0	0	0	0	0	0	0

ZERO DEGREE BOOM ANGLE LOADS (LB) / (RADIUS (FT.))

MIN. BOOM ANGLE (DEG) FOR INDICATED BOOM LENGTH (NO LOAD)	-2
MAX. BOOM LENGTH (FEET) AT -2 DEGREE BOOM ANGLE (NO LOAD)	126

GENERAL NOTES

GENERAL

1. Rated loads as shown on lift charts pertain to this machine as originally manufactured and equipped. Modifications to the machine or use of optional equipment other than that specified can result in a Reduction of capacity.
2. Construction equipment can be hazardous if improperly operated or maintained. Operation and maintenance of this machine shall be in compliance with the information in the Operators, Parts and Safety Manuals supplied with this machine. If these manuals are missing, Order replacements from the manufacturer thru your distributor.
3. These warnings do not constitute all of the operating conditions for the crane. The operator and job site supervision must read the OPERATORS MANUAL, CIMA SAFETY MANUAL. APPLICABLE OSHA REGULATIONS, AND SOCIETY OF MECHANICAL ENGINEERS (ASME) SAFETY STANDARDS FOR CRANES.
4. This crane and its load ratings are in accordance with POWER CRANE & SHOVEL ASSOCIATION, STANDARD NO. 4 SAE CRANE LOAD STABILITY TEST CODE J765A, SAE METHOD OF TEST FOR CRANE STRUCTURE J1063 AND APPLICABLE SAFETY CODE FOR CRANE, DERRICKS AND HOISTS, ASME/ANSI B30.5.

DEFINITIONS

1. **LOAD RADIUS**- The horizontal distance from the axis of rotation Before loading to the center of the vertical hoist line or tackle with a Load applied.
2. **LOADED BOOM ANGLE**- It is the angle between the boom base Section and the horizontal, after lifting the rated load at the rated Radius. The boom angle before loading should be greater to account for deflections. The loaded boom angle combined with boom length give only an approximation of the operating radius.
3. **WORKING AREA**- Areas measured in a circular arc about the centerline of rotation as shown in the diagram.
4. **FREELY SUSPENDED LOAD**- Load hanging free with no direct External force applied except by the hoist rope.
5. **SIDE LOAD**- Horizontal force applied to the lifted load either on the ground or in the air.
6. **NO LOAD STABILITY LIMIT**- The stability limit radius shown on the range diagrams is the radius beyond which it is not permitted to position the boom, when the boom angle is less than the minimum shown on the applicable load chart, because the machine can overturn without any load.

SET-UP

1. Crane load ratings are based on the crane being leveled and standing on a firm, uniform supporting surface.
2. Crane load ratings on outriggers are based on all outrigger beams being fully extended or in the case of partial extension ratings mechanically pinned in the appropriate position, and the tires free of the supporting surface.
3. Crane load ratings on tires depend on appropriate inflation pressure and the tire conditions. Caution must be exercised when increasing air pressure in tires. Consult operator's manual for precautions.
4. Use of jibs, lattice-type boom extensions, our fourth section pullouts extended is not permitted for pick and carry operations.
5. Consult appropriate section of the Operator's and Service manual for more exact descriptions of hoist line reeving.
6. The use of more parts of line than required by the load may result in having insufficient rope to allow the hook block to reach the ground.
7. Properly maintained wire rope is essential for safe crane operation. Consult Operator's Manuals for proper maintenance and inspection requirements.

8. When spin resistant wire rope is used, the allowable rope loading shall be the breaking strength divided by 5, unless otherwise specified by the wire rope manufacturer.

OPERATION

1. **CRANE LOAD RATINGS MUST NOT BE EXCEEDED. DO NOT ATTEMPT TO TIP THE CRANE TO DETERMINE ALLOWABLE LOADS.**
2. When either radius or boom length, or both, are between listed values, The smaller of the two listed load ratings shall be used.
3. Do not operate at longer radii than those listed on the applicable load rating chart (cross hatched areas shown on range diagrams).
4. The boom angles shown on the capacity chart give an approximation of the operating radius for a specified boom length. The boom angle before loading, should be greater to account for boom deflection. It may be necessary to retract the boom if maximum boom angle is insufficient to maintain rated radius.
5. Power telescoping boom sections must be extended equally.
6. Rated loads include the weight of hook block, slings, and auxiliary lifting devices. Their weights shall be subtracted from the listed rated load to obtain the net load that can be lifted.
When lifting over the jib the weight of any hook block, slings, and auxiliary lifting devices at the boom head must be added to the load. When jibs are erected but unused add 2 times the weight of any Hook block, slings, and auxiliary lifting devices at the jib head to the loads.
7. Rated loads do not exceed 85% on outriggers or 75% on tires, of the tipping loads as determined by SAE Crane Stability Test Code J765A. Rated loads for partially extended outriggers are determined from the Formula. $\text{Rated Load} = (\text{Tipping Load} - 0.1 \times \text{Tip Reaction}) / 1.25$. Structural strength ratings in chart are indicated with an asterisk *.
8. Rated loads are based on freely suspended loads. No attempt shall be made to drag a load horizontally on the ground in any direction.
9. The user shall operate at reduced ratings to allow for adverse job conditions, such as soft or uneven ground, out of level conditions, high winds, side loads, pendulum action, jerking or sudden stopping of loads, hazardous conditions, experience of personnel, two machine lifts, traveling with loads, electric wires, etc. (side pull on boom or jib is hazardous) Derating of the cranes lifting capacity is required when wind speed exceeds 20-mph. The center of the lifted load must never be allowed to move more than 3* ft. off the center line of the base boom section due to effects of wind, inertia, or both.
***Use 2 feet off the center line of the base boom for a two section boom, 3 feet for a three section boom, or 4 feet for a four section boom.
10. The maximum load that can be telescoped is not definable, because of variations in loadings and crane maintenance, but it is Permissible to attempt retraction and extension if load ratings are not exceeded.
11. Load ratings are dependent upon the crane being maintained according to manufacturers specifications.
12. It is recommended that load handling devices, including hooks, and hook blocks, be kept away from boom had at all times.
13. **FOR TRUCK ONLY:** 360 deg. capacities apply only to machines equipped with a front outrigger jack and all 5 outrigger jacks properly set. If the front (5) outrigger jack is not properly set, the work area is restricted to the over side and over rear areas as shown on the crane Working positions diagram. Use the 360 deg. Load ratings in the overside work areas.

DEDUCTIONS TO BE MADE FROM LOAD RATINGS

HOOK BLOCK WEIGHTS

9.2 Ton Ball Hook	476 Pounds	8.3 M Ton Ball Hook	213 Kg.
20 Ton 1 Sheave Hook Block	420 Pounds	18.1M Ton 1 Sheave Hook Block	190 Kg.
75 Ton 5 Sheave Hook Block	1,220 Pounds	68M Ton 5 Sheave Hook Block	443 Kg.

Note: These weights apply only to TEREX, INC supplied equipment.

The load charts for the T750 are net load charts.
The deductions to these charts are:

1. The weight of hook block, slings and auxiliary lifting devices. Their weight must be subtracted from the listed rated lifting capacity to obtain the net load to be lifted.
2. When lifting over the lattice extension of the weight of any hook block, slings, and auxiliary lifting devices at the main boom head must be added to the load.
3. When the lattice extension is erected but unused, add three (3) times the weight of any hook block, slings, and auxiliary lifting devices at the extension head to the load. Outriggers must be in the fully extended position when lifting at the main boom head with the lattice extension erected.
4. Add 150 pounds to the chart values if the auxiliary boom head sheave is not erected.
5. All other deductions have been taken in the charts.

NOTE: All designs, specifications, and components of the equipment described above are subject to change at the manufacturer's sole discretion at any time and without advance notice. Capacity charts and information printed here are only a guide and may not be complete. They should not be relied upon to operate the crane. The individual load charts and related lifting data on each crane must be understood and govern operation of the crane. Data published herein is informational in nature and shall not be construed to warrant suitability of the machine for any particular purpose as performance may vary with conditions encountered. The only warranty applicable is out standard warranty for this machine.

 **TEREX CRANES, INC.**

P.O. Box 260002 Hwy. 501 East/Atlantic Center Conway, SC 29526-2602 U.S.A.
(803) 349-6900 FAX (803) 349-7090



Printed in USA
1997